

CRWR Online Report 95-5

**A REVIEW AND EVALUATION OF LITERATURE
PERTAINING TO THE QUANTITY AND CONTROL OF POLLUTION
FROM HIGHWAY RUNOFF AND CONSTRUCTION**

by

MICHAEL E. BARRETT, M.S.

ROBERT D. ZUBER, M.S.

E. R. COLLINS, III, M.S.

and

JOSEPH F. MALINA, JR., P.E.

Principal Investigator

and

RANDALL J. CHARBENEAU, P.E.

GEORGE H. WARD, Ph.D.

Co-Principal Investigators

April 1995

2nd Edition

CENTER FOR RESEARCH IN WATER RESOURCES

**Bureau of Engineering Research • The University of Texas at Austin
J.J. Pickle Research Campus • Austin, TX 78712-4497**

This document is available online via World Wide Web at
<http://www.ce.utexas.edu/centers/crwr/reports/online.html>

ACKNOWLEDGEMENTS

This research was supported under Texas Department of Transportation Project 1900 Task 5 and Project 1943, "Texas Quantity and Quality Impacts Assessment of Highway Construction in the Austin, Texas, Area."

The authors would like to thank Bennett Ponsford, Librarian at the Center for Transportation Research, for her help in acquiring many of the articles cited in this report. We also would like to express our appreciation for the constructive comments from the staff of the Barton Springs/Edwards Aquifer Conservation District, especially Bill Couch and Ron Fieseler. Finally, our thanks to Don Rauschuber for his review and input during the editing of this manuscript.

Preface

Requirements of the EPA's National Pollution Elimination Discharge System permits have increased the interest in understanding and treating sources of nonpoint source pollution. Runoff from city streets and highways is one such source. This publication attempts to summarize many of the previous studies on the nature of stormwater runoff from highways, its effects on the quality of receiving waters, and the current technology for improving runoff quality.

Since the first edition of this report was published in 1993, several additional articles have been published concerning highway runoff and its effects. All of the chapters have been extensively revised and expanded to include new material. The number of studies cited in the text has doubled. The discussion of the effects and control of sediment transport during highway construction has been greatly expanded to include additional documentation of the effects of runoff on the environment. Several studies documenting the performance of different types of sediment controls have now been included in this section. A new chapter on prediction of highway runoff quality is now included in this report. It compares and contrasts the three general types of models used for water quality prediction and discusses their applicability to highway runoff.

TABLE OF CONTENTS

ACKNOWLEDGMENTS	iii
PREFACE	v
TABLE OF CONTENTS	vii
LIST OF TABLES	ix
LIST OF FIGURES	xiii
EXECUTIVE SUMMARY	xv
1.0 INTRODUCTION	1
2.0 SOURCES OF POLLUTANTS	5
2.1 Vehicles.....	5
2.2 Atmospheric Deposition.....	7
2.3 Roadway Maintenance Practices.....	9
3.0 FACTORS AFFECTING HIGHWAY RUNOFF QUALITY	13
3.1 Traffic Volume.....	15
3.2 Precipitation Characteristics.....	18
3.2.1 Antecedent Dry Period.....	18
3.2.2 Rainfall Intensity	19
3.2.3 Runoff Volume.....	21
3.3 Highway Surface Type	22
3.4 Pollutant Characteristics.....	24
3.5 Surrounding Land Use and Seasonal Considerations.....	31
4.0 EFFECTS OF HIGHWAY RUNOFF	33
4.1 Biological Effects and Toxicity Testing.....	35
4.2 Streams, Rivers, and Lakes	39
4.3 Wetlands.....	42
4.4 Groundwater and Soil-Water	43

5.0	HIGHWAY CONSTRUCTION	51
5.1	Environmental Effects of Highway Construction	51
5.2	Performance of Erosion and Sediment Controls	60
6.0	CONTROLLING POLLUTION FROM HIGHWAY RUNOFF	69
6.1	Source Management	70
6.2	Street Sweeping	71
6.3	Vegetative Controls	73
6.4	Ponds	81
6.5	Wetlands	90
6.6	Infiltration Practices	92
6.7	Filters	102
6.8	Performance Enhancements	106
	6.8.1 Oil/Grit Treatment	107
	6.8.2 Sediment Forebays	108
	6.8.3 GAC Filters	109
6.9	Combined Systems	110
6.10	Comparative Studies	115
	6.10.1 Predicted Performance	115
	6.10.2 Field Evaluations	116
	6.10.3 Maintenance Considerations	121
6.11	Design Aids	124
7.0	PREDICTIVE MODELING OF HIGHWAY RUNOFF	129
7.1	Regression Equations	129
7.2	Simulation Models	131
7.3	Statistical Techniques	134
	BIBLIOGRAPHY	137

LIST OF TABLES

Table	Page
2.1 Emission Rates for Pollutants from Highway Sources (Ball et al., 1991).....	6
2.2 Estimated Loads of Selected Chemical and Physical Parameters in Bridge Surface Bulk Precipitation and in Bridge Surface Runoff (Irwin and Losey, 1978).....	7
2.3 Summary of Dustfall Loading Rate for Monitoring Sites (Gupta et al., 1981c).....	9
2.4 Loadings of Total Solids in Highway Runoff, Non-Winter Periods of 1976 and 1977 (Gupta et al., 1981c).....	9
2.5 Highway Maintenance Practices (Kramme et al., 1985c)	11
3.1 Constituents of Highway Runoff.....	14
3.2 Pollutant Concentrations in Highway Runoff Site Median Concentrations (Driscoll et al., 1990c).....	16
3.3 Results of Correlation Analysis for Peak Pb Concentrations in Runoff Water (Harrison and Wilson, 1985a).....	19
3.4 Ranges of Loadings (1988-89 Storms) (Horner et al., 1990a)	21
3.5 Average Concentrations (Wiland and Malina, 1976).....	23
3.6 Mass Loadings (Wiland and Malina, 1976)	23
3.7 Yearly Pollutant Loads in Highway Surface Runoff (Stotz, 1987).....	25
3.8 Concentration of Total and Dissolved Lead, Zinc, and Iron at Various Sites (Gupta et al., 1981c)	26
3.9 Extractable Organics in Runoff Classified into Nine Categories (Zowlocki et al., 1980)	28

4.1	Significance of Differences in Heavy Metal Concentrations in Water Samples from Maitland Interchange (Yousef et al., 1982)..	39
4.2	Significance of Differences in Heavy Metal Concentrations in Bottom Sediments from Maitland Interchange (t-test Analysis) (Yousef et al., 1982).....	39
4.3	Comparison Between Total Metal Concentrations in Bridge Runoff and Lake Ivanhoe Water Samples (Wanielista et al., 1980).....	40
4.4	Median Values of Characteristics of Stormwater, Groundwater, and Precipitation, Recharge Basin, Plainview, New York (Ku and Simmons, 1986)	45
4.5	Lysimeter Water Quality Data (mg/L) - Milwaukee I-94 Site (Kobriger and Geinopolos, 1984).....	49
4.6	Lysimeter Water Quality Data (mg/L) - Harrisburg I-81 Site (Kobriger and Geinopolos, 1984b).....	50
6.1	Average Concentrations of Dissolved Pollutants Flowing over Roadside Swales (Yousef et al., 1985a).....	75
6.2	Concentrations of Constituents in Wet Pond Sediments (Derived from Yousef et al., 1991)	86
6.3	Estimated Performance of a Sediment Forebay (from Driscoll, 1989).....	109
6.4	Detention Pond/Filtration Berm Phosphorus Treatment Potential (from Holler, 1990)	115
6.5	Removal Efficiencies (%) Measured at City of Austin Facilities (Modified from City of Austin, 1990).....	117
6.6	Overall Pollutant Removal Efficiency (%), Effect of Filter Strip Length (from Yu and Benelmouffok, 1988).....	119
6.7	Overall Removal Efficiency of Two Systems (Modified from Yu and Benelmouffok, 1988).....	119
6.8	Comparative Pollutant Removal of Control Structure Designs (from Schueler, 1987; Galli, 1990)	126

7.1	Mean Percent Difference for Measured vs. Predicted Pollutant Loads, Broward County, Florida, Highway Site (modified from Driscoll et al., 1990c)	131
-----	--------------------------------------------------------------------------------------------------------------------------------------------------------	-----

LIST OF FIGURES

Figure		Page
3.1	Rainfall Intensity and Pollutant Concentrations (Hoffman et al., 1985)	20
3.2	First Flush for Solids and COD (Horner et al., 1979)	29
3.3	Concentration of Particles and Particulate-Associated Metals (Hewitt and Rashed, 1992)	31
6.1	Metal Concentration in Surface Soil Near a Highway (Wang et al., 1980)	76
6.2	Swale Modified with Swale Blocks	79
6.3	Effect of Pond Depth on Wet Pond Treatment Efficiencies for TSS and Total P (Modified from Maristany, 1989)	89
6.4	Drainage Well Installations (Modified from Jackura, 1980)	93
6.5	Curb Inlet Dry Well (Modified from Maryland Department of the Environment, 1984a)	94
6.6	Infiltration Trench Cross-Section (Modified after Harrington, 1989)	97
6.7	Typical Sand Filter Cross-Section	102
6.8	Moduled Sedimentation/Filtration Chambers (Modified from Kile and Wendland, 1989)	108
6.9	Site Layout of the Combination Detention/Filtration Pond (Modified from Holler, 1990)	114
6.10	Cross-Section of Filter Berm (Modified from Holler, 1990)	114
6.11	Comparison of Treatment Efficiencies for TSS of Wet Ponds and Retention/Filtration Basins (Modified from Maristany, 1989)	116
6.12	Pollutant Removal Efficiencies Associated with Different Pond Structures (Modified from MWCOG, 1983)	119

6.13	Comparison of Independent Methods Used to Calculate Wet Pond Removal Efficiencies (Modified from MWCOG, 1983).....	120
6.14	Observed Removal Rates in Experimental Settling Column Studies After 6 Hours and 48 Hours (Modified from MWCOG, 1983).....	122

EXECUTIVE SUMMARY

Sources of Pollutants

Vehicles directly and indirectly contribute much of the pollution found in highway runoff. Vehicles are a source of the metals, chemical oxygen demand, oil and grease, and other materials deposited on highways. Other major sources of contaminants in the runoff include dustfall and dissolved constituents in the rain itself. Rainfall can contribute the majority of ionic contaminants leaving the road surface in runoff and can also wash vehicle derived pollutants out of the atmosphere. Dustfall loadings can be a significant fraction of the loadings in runoff and an important source of highway pollution. This is especially true for highways near or in urban areas. Thus the surrounding land use has a major impact on the amount of pollution in dustfall deposited on a highway and the ensuing quality of stormwater runoff. A number of common highway maintenance practices also may adversely affect water quality. The nature of the materials and methods used and the proximity of the maintenance activity to a body of water increases the likelihood of adverse effects.

Factors Affecting Highway Runoff Quality

Numerous factors may affect the quality of highway runoff including: traffic volume, precipitation characteristics, roadway surface type, and the nature of the pollutants themselves. No definitive relationship between any of these variables and the concentrations of pollutants in runoff has been reported. For many pollutants, the mass of pollutant in the runoff is more important for estimating the impacts of runoff on receiving water quality than is the instantaneous concentration. The pollutant load is largely a function of the volume of runoff rather than the concentration and is generally predicted more accurately.

Traffic volume would seem to be an important factor for predicting runoff quality; however, no clear relationship between traffic and water quality has been reported. This is true for both average daily traffic and the number of vehicles during a storm. Removal processes such as air turbulence (natural or the result of vehicles) limit the accumulation

of solids and other pollutants on road surfaces, thereby obscuring the relationship between the traffic volume and runoff loads.

The precipitation characteristics that may impact the water quality of highway runoff include the number of dry days preceding the event, the intensity of the storm, and storm duration. Only a weak correlation between antecedent dry days and runoff quality has been demonstrated. Storm intensity has a marked impact because many of the pollutants are associated with particles which are more easily mobilized in high intensity storms. Constituents showing a strong correlation with suspended solids include metals, organic compounds, total organic carbon, and biochemical oxygen demand. For low-intensity storms, other mechanisms (i.e., vehicles) are partially responsible for the removal of pollutants from highway surfaces. Larger storms dilute highway runoff and lower concentrations of contaminants. However, the loading of pollutants (total mass transported) is generally higher in longer storms, as the transport of at least some constituents continues throughout the duration of the event.

Higher concentrations of pollutants are often observed in the first runoff from a storm, a phenomenon referred to as the "first flush." This is especially true for dissolved components including nutrients, organic lead, and ionic constituents. In general, concentrations of particle-associated pollutants show a more complex temporal variation related to rainfall intensity and the flushing of sediment through the drainage system.

The effect of highway paving material (asphalt versus concrete) on the quality of highway runoff appears to be minimal. Most studies have found that highway surface type was relatively unimportant compared to such factors as surrounding land use. It has also been reported that the type of collection and conveyance system for highway runoff (storm sewer, grassy swale, etc.) has a greater effect on runoff quality than pavement type.

In addition to the general factors discussed above, the range of pollutant concentrations and loads can also be attributed to site-specific conditions or seasonal variations. Excess solid loadings have been connected to environmental sources as well as to highway maintenance practices.

Biological and Water Quality Effects of Highway Runoff

The type and size of the receiving body, the potential for dispersion, the size of the catchment area, and the biological diversity of the receiving water ecosystem are just some of the factors which determine the extent and importance of highway runoff effects. Highways increase the amount of impervious cover on a watershed and thus raise storm runoff volumes and peak discharges. Consequently, there is an increase in streambank erosion and greater loads of solids and other pollutants into receiving waters. More important than the total concentration of many pollutants is the form in which they occur and their bioavailability. In addition, hardness, alkalinity, and organic complexes affect the toxicity of heavy metals.

Bioassay tests of organisms from streams and lakes receiving highway runoff generally have not demonstrated acute toxicity, although very high traffic volumes or other site-specific conditions may produce a toxic response. Chronic toxicity resulting from bioaccumulation of pollutants in highway runoff has not been thoroughly investigated, although numerous studies have documented higher concentrations of metals in organisms living near highways.

Concentrations of pollutants in the water columns of receiving waters generally only show small changes due to highway runoff. This may be the result of dilution of the highway runoff by flow from the rest of the watershed. However, stream and lake sediments have been found to be a reservoir for heavy metals and the primary source for the bioconcentration of metals.

Highways can have a significant impact on groundwater, including changes in water quality in the vadose and saturated zones. Metals concentrations in groundwater have been detected at elevated levels in the vicinity of highways and runoff control structures. Highway runoff may also increase the concentration of constituents other than metals such as Kjeldahl nitrogen and organic compounds.

Highway runoff effects on groundwater are often spatially limited due to local hydrological conditions as well as sorption processes within and above the aquifer. Furthermore, the effects of runoff on groundwater are minimized by processes in the soils

such as precipitation and adsorption. These processes are highly dependent on the type and thickness of soil at a particular site; however, even thin soils can result in significant attenuation. Organic and ionic constituents are relatively mobile and may pose a threat to groundwater quality.

Highway Construction

Highway construction causes changes in turbidity, suspended solids concentration, and color of receiving waters. The higher suspended solids levels result in reduced diversity and density of fauna in the affected area. The extent and persistence of the changes vary from site to site, but conditions eventually return to pre-construction levels. The effects of highway construction activity may be obscured by other influences such as concurrent commercial development or nearby industry.

Groundwater quality can also be affected by highway construction activities. In areas of karst aquifers, these activities can expose caverns and other openings, allowing rapid transport of sediment into the aquifer.

Prevention of erosion during highway construction is necessary to minimize the effects on receiving waters. Of particular importance is achieving effective administrative control and enforcement by concerned agencies, and discussing erosion and sediment control plans with the contractor. A variety of control devices is generally required for each construction project.

The basic categories of temporary control methods are erosion and sediment control. Slope coverings combined with vegetative stabilization represent the primary component of erosion control. These coverings are very effective, but may not be appropriate during the active construction phase of a project. Sedimentation ponds, when designed with sufficient holding times, have proved useful for sediment control. Silt fences are also popular for sediment control, although little is known about their removal efficiency in the field. Proper installation techniques and materials are required to reduce the risk of common failures such as undercutting, end runs, holes and tears, over-topping, and fence collapse.

Controlling Pollution from Highway Runoff

The control of pollution from highway runoff can be accomplished by both source management and structural controls. Most of the pollutant load is either suspended particulate matter or material adsorbed to suspended solids. The most effective control measures reduce the amount of particulates available for transport, or settle and/or filter the particulate material in runoff.

Source management includes transportation plans, which can be designed to lower the total vehicle miles traveled, and the implementation of land use plans, which restrict developments that generate high traffic volumes in sensitive areas. Reduction of pollutant runoff can be accomplished by the elimination of curbs and other barriers, traffic-flow regulation, and minimizing the use of fertilizers and pesticides.

Several studies have reported that the effectiveness of street sweeping for reducing pollutant loads in runoff is low. Sweeping is most effective at removing the larger particles; however, pollutants are generally associated with the smaller particles, which have a larger surface area. There is some indication that measurable improvement in metals and solids concentrations in runoff could be obtained with frequent (i.e., twice weekly) sweeping.

Structural controls which are appropriate for highways include vegetative practices, ponds, infiltration methods, wetlands, and filters. Vegetative controls include the grassed swale and vegetated buffer strips. These controls are popular because of their low costs and minimum maintenance requirements. They have been shown to reduce concentrations of metals, oil and grease, and suspended solids. Removal of nutrients is often less effective. Factors that reduce the effectiveness of swales include steep slopes and fine-grained soils. Steep slopes contribute to high runoff velocities which mat the grass and reduce the time available for treatment and infiltration.

Different types of ponds used to treat highway runoff include detention, extended-detention and "wet" ponds. Detention ponds are primarily flood control devices and are designed to be dry between storm events. Because of the short detention times associated with these structures, they are neither reliable nor effective in treating highway runoff.

Extended-detention ponds are dry ponds designed to retain the runoff for 6 to 12 hours. This results in increased removal of particles and particle-associated pollutants. However, nutrient removal rates are low and sometimes even negative. The construction costs of dry ponds are generally the least of all those for pond options, but the maintenance burden is usually higher.

Wet ponds are considerably more effective at mitigating highway runoff pollution and are the best choice when vegetative controls are not feasible. These ponds are designed to maintain a permanent pool of water and to retain a certain amount of storm runoff. Pollutant removal is achieved primarily through sedimentation and biological processes. Many pollutants are retained in the pond sediments, but concentrations remain much lower than the EPA's criteria for hazardous waste designation. Pond depth, surface area, and shape are all important factors affecting pollutant removal. Costs for wet ponds are definitely higher than for other ponds, not including permitting costs, which may equal or exceed design costs in some cases. In addition, land cost and surrounding land use may restrict their applicability.

Constructed wetlands have the ability to assimilate large quantities of dissolved and suspended solids and exhibit a high nutrient demand. Pollutant removal is achieved primarily through plant uptake, physical filtration, adsorption, gravitational settling, and microbial decomposition. The high cost of wetlands is usually associated with their increased land requirements, which may be two to three times the space required for other control methods. Wetlands are difficult to establish in areas with high soil permeabilities or high evapotranspiration rates.

Infiltration trenches and basins are designed to contain a certain volume of highway runoff and treat it through percolation into the underlying subsoil or through a prepared porous media filter bed. Although not well documented, pollutant removal rates appear to be very high. These controls are highly dependent on specific site conditions, so they may not be applicable in many areas. Costs for infiltration structures are higher than for pond systems especially when based on volume of runoff treated, and maintenance appears to be a serious problem. Most infiltration basins have failed due to rapid clogging, usually within 5 years.

Sand filters treat stormwater runoff by percolating it through sand beds, after which it is collected in drainage pipes and discharged downstream. Removal rates are high for suspended solids and trace metals, and moderate for biochemical oxygen demand, nutrients and fecal coliform. Sand filter performance can be increased by incorporating peat into the filter material. These filters are useful in areas with thin soils, soils with low infiltration rates, and areas of high evapotranspiration. Construction costs are very high and maintenance is required on a regular basis to prevent clogging of the sand bed with sediment.

Several structural additions have been used in conjunction with primary runoff controls to increase their performance. These additions include oil/grit chambers, sediment forebays, and granular activated carbon filters. Oil and grit chambers used to remove heavy particulates and adsorbed hydrocarbons are relatively ineffective due to their high maintenance requirements. Sediment forebays have been shown to be useful in reducing the sediment load to infiltration structures and sand filters. Granular activated carbon has been used to treat runoff before discharge to underground drainage wells, but it is very expensive.

Pollutant removal can also be increased by combining several of the structural control devices. Combinations may increase the ability to effectively filter suspended solids or may be useful in reducing the site limitations of a single control measure. The redundancy of expected pollutant removal efficiencies increases the overall reliability and performance of the system.

For highway runoff, most design references specify vegetated controls as their first choice because of their wide adaptability, low costs, and minimal maintenance requirements. Wet ponds are recommended when site conditions are not conducive to vegetated controls. Infiltration practices, although offering excellent treatment potential, are the least desirable because of their high maintenance requirements.

Predictive Modeling of Highway Runoff

Regression equations, simulation models, and the statistical method are analytical tools for predicting pollutant loads from highway runoff. The primary advantage of the

regression and statistical methods is that both allow a relatively quick, simple, and inexpensive screening of stormwater problems. This is particularly useful in the early stages of the planning process (Driscoll et al., 1990c).

Each method has its own particular advantages and disadvantages. The regression methods are simple and include causative mechanisms such as rainfall characteristics, traffic counts, highway lengths, etc. On the other hand, only the mean is predicted for a given set of inputs. Furthermore, regression relationships are notoriously difficult to apply beyond the original data set from which they were derived (Driscoll et al., 1990c).

The statistical method requires rainfall statistics (readily available) and known mean concentrations of pollutants in the runoff (somewhat harder) as input variables (plus streamflow statistics if that extension of the methodology is to be used). The output of a frequency distribution for water quality is tremendously useful, however, since assessments of risk and return periods can be made. The method makes many approximations in the interest of obtaining an analytical solution, some of the approximations are important in individual cases. The other difficulty with the method is that it is difficult to determine the effectiveness of control options or changes in the catchment (Driscoll et al., 1990c).

Simulation models require the most work, especially in terms of calibration and verification data requirements, but also produce the most varied output. For instance, continuous simulation can be used to derive the same statistics as produced by the statistical method and without as many limiting assumptions. The models are the most versatile in terms of assessing the effectiveness of control options and runoff changes due to changes in the catchment or other input variables, especially at the design phase. They are practically useless for predictions of absolute values of concentrations and loads without adequate, site-specific water quality data for calibration and verification (Driscoll et al., 1990c).

Simulation models could be based on either local monitoring data or keyed to the predictions generated by the statistical technique. Sensitivity analyses by a simulation model could be used to address some of the simplifications and assumptions associated with the statistical approach. Conversely, the statistical approach can be used to reduce

the number of more costly and time-consuming analyses that might be called for in a situation where a simulation model was selected for use in a local analysis (Driscoll et al., 1990c).

Recommendations for Future Studies

Structural controls for treating stormwater runoff are becoming increasingly common; however, little quantitative work has been done to establish the most effective designs. Replacing part of the sand in the filter with other adsorbing materials may increase the removal of heavy metals and other pollutants. Design parameters which require a better understanding include optimum filter thickness, filter media composition, optimum detention time, and effect of antecedent dry periods on filter performance.

The testing of structural controls will require an accurate characterization of the composition of highway runoff. The ability to predict highway runoff quality has been limited by the many variables which combine to make each storm event unique. Differences in antecedent dry period, rainfall intensity, traffic volume, surrounding land use, highway surface type, and drainage method results in a wide range of concentrations for many of the pollutants observed in runoff.

Studies of the constituents in highway runoff have been conducted in many parts of the United States; however, little research has been done in the Southwest. Many studies also do not consider important parameters such as rainfall intensity or the temporal distribution of pollutants in runoff. Pollution control structures often are designed to collect the "first flush" of runoff (commonly the first 1/2 inch), but the highest concentrations of pollutants may occur only when rainfall intensity exceeds the level necessary to transport particles from the road surface. In addition, rain and dustfall have been shown to contribute significant amounts of pollutants to highway runoff. Consequently, a runoff sampling program in Texas could help establish whether regional differences are important, determine the types and amounts of pollutants contributed by the atmosphere in this area, and identify what portion of the runoff should be collected and treated.

Although a few studies have examined temporary runoff controls at construction sites, very little data are available on the relative effectiveness of silt fences and rock berms. These devices are commonly used for the containment and retention of sediment and pollutant load. A program to monitor these temporary controls at highway construction sites could provide valuable information on their performance, maintenance requirements, and life span.

Little is known about the effects of highway runoff on groundwater quality in a karst terrane (cavernous limestones with thin soils). Other studies which have shown minimal effects on groundwater quality have been located in areas with fairly thick soils, which immobilize many of the pollutants in runoff. In the Austin, Texas, area, groundwater recharge to the Edwards aquifer occurs primarily in stream beds during storm events. For this reason, it would be useful to establish a field sampling program of the quantity and quality of the surface water in the creeks and drainage ways affected by highway construction and operation.

1.0 INTRODUCTION

Regulatory agencies have recently focused attention on nonpoint sources of pollution such as urban runoff. The EPA's National Pollutant Discharge Elimination System (NPDES) regulations regarding stormwater runoff are evidence of this effort.

In Texas, the Barton Springs/Edwards Aquifer Conservation District (the District) and several environmentally oriented organizations became concerned about the potential for aquifer contamination as a result of proposed highway construction activities over the Edwards aquifer. The proposed construction corridor crosses and parallels three creeks and overlies a portion of the recharge zone of the Barton Springs segment of the Edwards aquifer. This concern resulted in litigation involving the Texas Department of Transportation (TxDOT) and the Federal Highway Administration (FHA), which temporarily halted construction activities on the project site.

Prior to this halt in construction, the District and TxDOT negotiated a settlement between their two agencies which was approved by the U. S. District Court. The District removed itself from the litigation and TxDOT began implementing certain actions and practices to answer the concerns of the District. By working cooperatively, the two agencies have been effective in preventing or reducing pollution from both point and nonpoint sources during roadway construction activities. Many improvements and innovations have been developed for structural and non-structural Best Management Practices (BMPs) which have gained both agencies local, state, and national recognition as leaders in the field of pollution prevention and mitigation.

The agreed-to Consent Decree also ordered a study of the water quality and quantity of highway runoff and the effects of highway construction and operation on the quality of receiving waters. TxDOT and the District agreed to have the study conducted by the Center for Research in Water Resources (CRWR) at The University of Texas at Austin. A technical review committee consisting of three representatives of the District, two from TxDOT, and two from the CRWR meets regularly to review recent activities and progress reports. The committee provides input and guidance to the CRWR on the overall study, its procedures, equipment, and upcoming work efforts.

The study requires a review of previous research into the quality of stormwater runoff, the environmental impacts of highway construction and operation, and feasible mitigation strategies to control the negative effects of highway runoff. This literature review has been prepared in partial fulfillment of the requirement for review of prior studies.

Although most of the published literature pertaining to the constituents within runoff from paved surfaces is focused on urban runoff, some literature dealing specifically with runoff from highways does exist. Many of the reports on this subject constitute gray literature, documents published by the Federal Highway Administration (FHWA) or state departments of transportation throughout the country. Major studies of this type include those conducted by Envirex/Rexnord (Gupta et al., 1981a,b,c,d; Kobriger et al., 1981a,b, 1984a,b,c; Dupuis 1985a,b,c,d), Versar (Burch et al., 1985a,b; Maestri et al., 1985a,b), and Woodward-Clyde Consultants (Driscoll et al., 1990a,b,c,d), and which were summarized by Smith and Lord (1990). Most of the reports were obtained through/from the Center for Transportation Research at The University of Texas at Austin, the Technology Transfer Library at TxDOT, DOT libraries in the states of Washington and Florida, and the National Technical Information Service (NTIS). The literature review has been aided by computer searches of data bases such as TRIS, COMPENDEX and the Water Resources Reference Service. A summary of information dealing with other aspects of highway pollution such as atmospheric effects was presented by Hamilton and Harrison (1991).

This review is divided into six parts. The first, "Sources of Pollutants," discusses the amounts and types of pollutants derived from vehicles as well as other sources. "Factors Affecting Highway Runoff Quality" reports on the pollutants found in highway runoff, several factors which influence the amount of runoff and pollution, and the processes involved in the transport and transformation of highway related pollutants. Runoff concentrations and loads reported in several studies are discussed and the possible reasons for the wide range of values are evaluated. "Effects of Highway Runoff" analyzes the effect of highway runoff on streams, rivers, lakes, wetlands, soil-water, and groundwater. The range of quantitative data is explained in terms of the relevant factors

such as transport and transformation processes. “Highway Construction” discusses the important constituents in runoff from construction sites and analyzes the effects on receiving water quality. Also discussed are methods to minimize construction impacts. “Controlling Pollution from Highway Runoff” reviews source management and summarizes the results from studies of permanent pollution controls designed to protect receiving waters from the possible effects of highway runoff. Structural devices such as filters, swales, and ponds, and non-structural measures such as planning and maintenance are considered. Predictive Modeling of Highway Runoff contains descriptions of the common approaches to the prediction of runoff water quality.

2.0 SOURCES OF POLLUTANTS

Major sources of pollutants on highways are vehicles, dustfall, and precipitation. Many factors affect the type and amounts of these pollutants, including traffic volume and type, local land use, and weather patterns. Roadway maintenance practices such as sanding and deicing, or the use of herbicides on highway right-of-ways, may also act as sources of pollutants.

Other possible, but infrequent, sources of pollutants include spills of recreational vehicle wastes, agricultural or chemical products, or oil and gas losses from accidents. These losses are related to traffic volume and may often go unnoticed, but could result in a large pollutant load locally (Asplund et al., 1980).

2.1 Vehicles

Vehicles are both a direct and indirect source of pollutants on highways. As a direct source, vehicles contribute pollutants from normal operation and frictional parts wear. Indirect or acquired pollutants are solids that are acquired by the vehicle for later deposition, often during storms (Asplund et al., 1980).

Habibi (1973) states that the particulate matter emitted from the exhaust of cars is a complex mixture of lead salts, iron as rust, base metals, soot, carbonaceous material, and tars. The composition and total particulate emission rate are determined by many factors including the mode of vehicle operation, the age and mileage of the car, and the type of fuel.

Ball et al. (1991) report that vehicle exhaust is responsible for virtually all of the carbon monoxide, nitrogen oxides, and lead compounds emitted. It also accounts for about 65% of the hydrocarbons, with the remainder derived from crankcase blowby and evaporation from the carburetor. They also state that wear of automotive components and corrosion of bodywork contribute to loadings, especially heavy metals. Pollutant generation by wear and abrasion is generally inferred from mass loss estimates. Leakage of brake fluid, antifreeze compounds, transmission fluid, engine oil, and grease results in a direct input to the highway surface. Tire wear contributes oxidizable rubber

compounds and zinc oxides (Christensen and Guinn, 1979). Table 2.1 shows estimated emissions rates from two types of vehicle.

Not all of the hydrocarbons in runoff can be attributed to vehicles. Yamane et al. (1990) demonstrated that automobiles were the source of aliphatic hydrocarbons present in the Nogawa River during periods of stormwater runoff; however, polycyclic aromatic hydrocarbons (PAHs) were not derived from vehicles, but from other environmental sources. Conversely, Evans et al. (1990) found that highway runoff was a major influence on PAH levels in river sediment, but that atmospheric deposition was also important.

Table 2.1
Emission Rates for Pollutants from Highway Sources
(Ball et al., 1991)

Pollutant	Emission Rate (g/km/vehicle)	
	Gasoline	Diesel
CO	10	1
Total Hydrocarbons	1	0.3
NO _x	3	6
SO ₂	0.03	0.2
Pb (assuming 0.15 g/L)	0.01	0
Particulate Elemental Carbon	0.001	0.13
Benzo(a)pyrene	7×10^{-7}	2×10^{-6}
Fluoranthene	2×10^{-5}	4×10^{-5}
Zn	0.003	0.003
Cd	1×10^{-6}	1×10^{-6}
Cu	4.5×10^{-5}	4.5×10^{-5}

Indirectly, vehicles contribute to highway pollution by carrying solids from parking lots, urban roadways, construction sites, farms, and dirt roads. Shaheen (1975) showed that more than 95% of solids on a given highway originate from sources other than the vehicles themselves.

2.2 Atmospheric Deposition

Atmospheric sources contribute a significant amount of the pollutant load in highway runoff. The deposition may occur in precipitation during storms or as dustfall during dry periods.

Annual loads of physical and chemical constituents in bulk precipitation to a rural highway bridge were estimated by Irwin and Losey (1978) by extrapolating from five individual events. Bridge surface runoff loads were estimated by washing the bridge surface with distilled water at predetermined intervals to determine the rate of accumulation of constituents on the roadway. The contribution from vehicles during storm events was not addressed in this study. Bulk precipitation loads were a significant fraction of the road surface load for many constituents (Table 2.2). Precipitation loads were even higher than the surface loads for some dissolved constituents (e.g., chloride, sodium, and dissolved solids).

Table 2.2
Estimated Loads of Selected Chemical and Physical Parameters in Bridge Surface Bulk
Precipitation and in Bridge Surface Runoff
(Irwin and Losey, 1978)

Parameter	Bulk Precipitation (lb/yr)	Bridge Surface Runoff (lb/yr)
Dissolved solids	280	220
Sodium (Na)	14.3	2.9
Chloride (Cl)	26	6.9
Suspended solids	138	1,210
Oil and grease	17.9	9.1
Nitrogen (N)	11.3	14.6
Phosphorus (P)	.58	1.8
Organic carbon	17.9	78.8
BOD	21.5	45.6
Chromium (Cr)	< .20	< .15
Copper (Cu)	.08	.44
Lead (Pb)	1.04	2.60
Mercury (Hg)	< .01	< .01
Nickel (Ni)	.11	.11
Zinc (Zn)	.32	1.60

Many major ionic constituents originate from atmospheric pollution. Bellinger et al. (1982) monitored 11 events and found that rainfall contributed an average of 2% of the major ionic contaminants (Na^+ , K^+ , Mg^{2+} , Ca^{2+} , Cl^- , and SO_4^{2-}) leaving the road surface in runoff and about 10% of the suspended solids. The values for individual storms were quite variable, however, with rainfall contributing up to 78% of the ionic constituents and up to 48% of the suspended solids.

Rainfall can also wash vehicle-derived pollutants out of the atmosphere. Harrison et al. (1986) studied seven storms and concluded that the washout of alkyllead from the atmosphere was the major source of alkyllead compounds in the drainage waters analyzed. These compounds were also identified in rainwater collected at other sites, but not in road surface dust or bottom sediment from the drainage way.

Atmospheric dry fallout can also contribute large amounts of pollutants to highway surfaces. Irwin and Losey (1978) and Harrison and Wilson (1985a) discussed, but did not quantify, this phenomenon. Table 2.3 summarizes the dustfall loading measured by Gupta et al. (1981c). The significance of this dustfall loading can be seen by comparison with the highway runoff loading of total solids presented in Table 2.4. The average values in runoff are loadings per event, and for each site they are approximately ten times the dustfall values given in Table 2.3, which are loadings per day. It is interesting to note that the average dry period between events for these non-winter periods was approximately ten days. If all the dustfall remained on the highway, dustfall load would approximately equal the load in the runoff.

Surrounding land use has an important effect on the amount and types of pollution in dustfall. Highways in or near urban areas have been shown to have significantly higher levels of pollutant loading from dustfall than those in rural areas (Gupta et al., 1981c).

Table 2.3
Summary of Dustfall Loading Rate for Monitoring Sites (gm/m²/day).
(Gupta et al., 1981c)

Monitoring sites	1976			1977			
	Non-Winter ^a		Winter ^b	Non-Winter ^a		Winter ^b	
	Avg.	Range	Typical value	Avg.	Range	Avg.	Range
Milwaukee-Hwy. 794	0.30	0.12-0.52	0.87	0.56	0.11-2.45	0.15	0.10-0.21
Milwaukee-Hwy. 45	0.21	0.03-0.38	0.11	0.31	0.05-0.58	0.13	0.06-0.20
Harrisburg	0.13	0.07-0.16	0.07	0.06	0.04-0.09	0.07	0.05-0.09
Nashville	0.30	0.23-0.38	NS	0.90	0.37-2.07	1.43	0.53-2.17
Denver	0.37	0.30-0.49	NS	0.32	0.07-0.68	0.34	0.27-0.46

Note: NS = no dustfall samples taken during this period.

^a Represents monitoring periods between April through October.

^b Represents monitoring periods between November through March.

Table 2.4
Loadings of Total Solids in Highway Runoff, Non-Winter Periods
of 1976 and 1977 (Gupta et al., 1981c)

Site	Average (gm/m ² /event)	Range (gm/m ² /event)
Milwaukee -Hwy 794	3.8	0.2 - 9.2
Milwaukee -Hwy 45	3.2	0.4 - 9.2
Harrisburg	1.9	0.2 - 8.2
Nashville	3.7	0.1 - 6.5
Denver	2.4	0.2 - 7.3

2.3 Roadway Maintenance Practices

Kramme et al. (1985a,b,c) reported that a number of common highway maintenance practices may adversely affect water quality. The proximity of the maintenance activity to a body of water increases the likelihood of adverse effects. The nature of the materials and methods used in the activity may also affect the impact. A number of factors increase the chance of adverse impact including:

- Exposing or moving soil or sediment, including activities that result in accidental or incidental removal of vegetative cover,
- The use or disposal of toxic components, especially if such components are leachable,
- The use or disposal of materials containing nutrients,
- The use or disposal of decomposable organic materials,
- The use or disposal of materials that could change the turbidity, pH, or suspended or dissolved solids content of the receiving body of water.

Table 2.5 contains a list of maintenance practices organized according degree of to water quality impact. Possible mitigation measures for those practices that have the potential to impact water quality are discussed by Kramme et al. (1985c).

The effects of sanding and deicing during the winter months have shown in several studies to increase loadings of suspended and dissolved solids to receiving waters. A study of runoff quality in the State of Washington (Asplund et al., 1980) found that a major fraction of solids loadings could be traced to sand used during winter ice conditions. The environmental impacts of road salting were discussed by Jones et al. (1992). They found that salt in roadside soils decreases aeration and water availability in soils through structural changes as sodium replaces calcium in the anion exchange process. Roadside vegetation is damaged because salt places more osmotic pressure on plants. The tolerance of animals to salt water is generally high, and increased salt concentrations in ground and surface waters are rarely a problem. Laxen and Harrison (1977) report that impurities in deicing salts may be a major source of the metals nickel and chromium.

The use of herbicides to control weeds and brush is increasing as an alternative to the more labor intensive and costly practices such as mowing. Herbicides are toxic to aquatic life, although not to the same degree as insecticides (Kramme et al., 1985a).

Table 2.5
Highway Maintenance Practices
(Kramme et al., 1985c)

Maintenance practices which can have a probable impact

- Repairing slopes, slips, and slides
- Cleaning ditches, channels, and drainage structures
- Repairing drainage structures
- Bridge painting
- Subsurface repair
- Chemical vegetation control

Maintenance practices which can have a possible impact

- Full depth repairs
- Surface treatments
- Blading and restoring unpaved berms and/or ditches
- Bridge surface cleaning
- Bridge deck repairs
- Mowing
- Planting or care of shrubs, plants, and trees
- Seeding, sodding, and fertilizing
- Application of abrasives
- Care of rest areas
- Washing and cleaning maintenance equipment
- Bulk storage of moter fuels
- Disposal of used lubricating oils

Maintenance practices which have no probable impact

- Blading unpaved surfaces
- Pothole patching
- Surface repairs
- Filling and sealing joints and cracks
- Pavement jacking
- Planing pavements - bituminous and concrete
- Bridge joint repair
- Superstructure repair
- Cleaning pavement
- Guardrail repair
- Snow plowing
- Crash attenuator repair
- Snow fence installation and removal
- Highway lighting
- Flat sheet, side-mounted, and overhead sign maintenance
- Pavement marking
- Bulk storage of non-fuel materials
- Controlling and disposal of roadside litter

3.0 FACTORS AFFECTING HIGHWAY RUNOFF QUALITY

There are many mechanisms for the removal of pollutants from highways. These include stormwater runoff, wind, vehicle turbulence, and the vehicles themselves.

The major pollution removal mechanisms in low precipitation areas are natural surface winds and traffic-created turbulence (Aye, 1979). The mechanical scrubbing action of the tires together with wind (both natural and vehicle created) scour the road and transport pollutants away from vehicle lanes and the highway (Asplund, 1980). Supporting this conclusion are studies which have shown that the majority of pollutants are located within 3 feet of the curb (Laxen and Harrison, 1977; Little and Wiffen, 1978).

Hamilton et al. (1987) measured airborne suspended particulates, surface dust, and stormwater runoff and their aerial deposition rates. They found that the mass of metal deposited greatly exceeds the mass removed by washoff for all metals. Hewitt and Rashed (1990) reported that only 8% of the lead emitted by vehicles was removed in runoff, while 6% was deposited in soils adjacent to the roadway and about 86% was dispersed by the atmosphere away from the vicinity of the road. They also found that between 70% and 99% of PAHs were removed from the road environment by the atmosphere.

During periods of wet weather, the primary removal mechanism is stormwater runoff (Asplund, 1980). Removal may occur by other means as well. Chui et al. (1981) state that for low intensity storms, a significant amount of pollutants accumulate on vehicles themselves.

The remainder of this report will concentrate on the pollutant loads and concentrations in stormwater runoff. Many factors appear to influence the quality of stormwater runoff from highways, including traffic volume, precipitation characteristics, drainage characteristics, highway surface type, and the nature of the pollutants themselves. Complex interactions between these variables obscure simple correlations between individual variables and water quality.

Stormwater runoff from highways may contain many constituents including solids, metals, nutrients, and hydrocarbons. Concentrations of some constituents such as

solids and BOD may far exceed concentrations found in effluent from secondary wastewater treatment plants (Jodie, 1975). Concentration and loading of highway runoff constituents have been reported in several studies, and the data from individual reports were summarized by Driscoll et al. (1990d). A summary of these data, including the range of averages for each pollutant, is presented in Table 3.1. Because these values are averages, they do not reflect the maximum or minimum concentrations reported. Calculation of stormwater pollutant loads requires accurate flow measurement, and Kilpatrick et al. (1985) tested and reviewed equipment suitable for this purpose.

Table 3.1
 Constituents of Highway Runoff,
 Ranges of Average Values Reported in the Literature

<u>Constituent</u>	<u>Concentration</u> (mg/L unless indicated)	<u>Load</u> (kg/ha/year)	<u>Load</u> (kg/ha/event)
SOLIDS			
Total	437 - 1147		58.2
Dissolved	356	148	
Suspended	45 - 798	314 - 11,862	1.84 - 107.6
Volatile, dissolved	131		
Volatile, suspended	4.3 - 79	45 - 961	.89 - 28.4
Volatile, total	57 - 242	179 - 2518	10.5
METALS (totals)			
Zn	.056 - .929	.22 - 10.40	.004 - .025
Cd	ND - .04	.0072 - .037	.002
As	.058		
Ni	.053	.07	
Cu	.022 - 7.033	.030 - 4.67	.0063
Fe	2.429 - 10.3	4.37 - 28.81	.56
Pb	.073 - 1.78	.08 - 21.2	.008 - .22
Cr	ND - .04	.012 - 0.10	.0031
Mg	1.062		
Hg, x 10 ⁻³	3.22	.007	.0007
NUTRIENTS			
Ammonia, total as N	.07 - .22	1.03 - 4.60	
Nitrite, total as N	.013 - .25		
Nitrate, total as N	.306 - 1.4		
Nitrite + nitrate	0.15 - 1.636	.8 - 8.00	.078
Organic, total as N	.965 - 2.3		
TKN	0.335 - 55.0	1.66 - 31.95	.17
Nitrogen, total as N	4.1	9.80	.02 - .32
Phosphorus, total as P	.113 - 0.998	.6 - 8.23	

Table 3.1 continued

<u>Constituent</u>	<u>Concentration</u> (mg/L unless indicated)	<u>Load</u> (kg/ha/year)	<u>Load</u> (kg/ha/event)
MISCELLANEOUS			
Total coliforms organisms/100 mL	570 - 6200		
Fecal coliforms organisms/100 mL	50 - 590		
Sodium		1.95	
Chloride		4.63 - 1344	
pH	7.1 - 7.2		
Total Organic Carbon	24 - 77	31.3 - 342.1	.88 - 2.35
Chemical Oxygen Demand	14.7 - 272	128 - 3868	2.90 - 66.9
Biological Oxygen Demand (five day)	12.7 - 37	30.60 - 164	0.98
Polyaromatic Hydrocarbon (PAH)		.005 - .018	
Oil and Grease	2.7 - 27	4.85 - 767	.09 - .16
Specific conductance (µS at 25 C)	337-500		
Turbidity (JTU)	84 - 127		
Turbidity (NTU)	19		

The averages may be for a particular site or may represent an average of several sites examined in one study. Concentrations are reported in mass per volume of runoff, but loads are commonly reported in several forms: mass/area/time, mass/area/event, mass/length of road/time, mass/length of road/number of vehicles, and mass/area/inches of runoff. The first two formats are the most prevalent and are the only two listed in Table 3.1. To explain the wide range of values in Table 3.1, several factors must be considered, including the processes involved in the deposition and transport of the pollutants.

3.1 Traffic Volume

Vehicles are one of the major sources of pollutants in highway runoff; therefore, the amount of traffic on a given stretch of highway should influence the accumulation of pollutants on the highway surface. However, vehicle turbulence can also remove solids and other pollutants from highway lanes and shoulders (Kerri et al., 1985; Asplund et al., 1980), obscuring the relationship between traffic volume, pollutant loads, and

concentrations in runoff. Furthermore, there are two measures of traffic volume which must be considered: average daily traffic (ADT) and vehicles during a storm (VDS).

The results of several reports indicate that there is only a slight dependence of the quality of stormwater runoff on ADT. Driscoll et al. (1990c) found that runoff concentrations are two to four times higher from urban high-traffic sites (ADT > 30,000) than from nonurban low-traffic (ADT < 30,000) sites (Table 3.2). However, regression analyses of the data from the urban sites indicated no strong or definitive relationship between ADT and pollutant level. The data indicated no correlation of TSS, total solids, BOD, oil and grease, phosphorus, nitrate, TKN, or heavy metals with traffic density. Organic pollutants, including VSS, COD, and TOC showed the most consistent degree of correlation with traffic density. For these pollutants, ADT explained about 40 percent of the site differences.

Table 3.2
Pollutant Concentrations in Highway Runoff
Site Median Concentrations (mg/L)
(Driscoll et al., 1990c)

Pollutant	Urban Highways ADT > 30,000	Rural Highways ADT < 30,000
TSS	142	41
VSS	39	12
TOC	25	8
COD	114	49
Nitrate plus Nitrite	0.76	0.46
TKN	1.83	0.87
PO ₄	0.4	0.16
Copper	0.054	0.022
Lead	0.4	0.08
Zinc	0.329	0.08

Horner et al. (1979) also found a weak correlation between TSS concentrations and ADT, while Bourcier et al. (1980) found no correlation of metal loadings with ADT. Similar results were found when comparing runoff concentrations from highways of different traffic densities in studies by McKenzie and Irwin (1983), Irwin and Losey (1978), and Wanielista et al. (1980). Stotz (1987) concludes that “the amount of

pollutants discharged is not dependent on the traffic frequency, but much more on the characteristics of the area.” Mar et al. (1982) and Asplund et al. (1982) reached similar conclusions.

Conversely, VDS may be a significant factor in the determination of pollutant loads. Kerri et al. (1985) found that VDS is better than either ADT or the antecedent dry period as an independent variable used to predict loads of lead, zinc, COD, TKN, and TSS. Data on TSS loads were collected during a 5-year study by the Washington State Department of Transportation (Horner et al., 1979; Horner and Mar, 1983; Clark and Mar, 1980; Clark et al., 1981). A linear regression of cumulative TSS loads versus cumulative VDS for several sites in the state of Washington disclosed a strong relationship (Chui et al., 1981, Chui et al., 1982, Asplund et al., 1982, and Horner and Mar, 1983). The slopes of the regression lines (pounds of TSS per curb-mile per 1000 VDS) for each site varied from 3.21 to 46.76. This wide range can be attributed to differences in surrounding land-use, differences in precipitation patterns throughout the state, ashfall from the eruption of Mount St. Helens volcano, and varied applications of deicing materials.

Since pollutant load is a function of runoff volume as well as concentration, longer storms may be associated with greater runoff and will produce greater loads. In general, the longer the storm, the greater the number of vehicles which will pass through the site. So the apparent relationship between VDS and pollutant load may only be reflecting the importance of runoff volume.

Kobriger and Gupta (1984a) suggested several additional traffic factors which might influence runoff quality. These include:

1. Vehicular mix (percentage trucks/cars)
2. Congestion factors (braking), ramps, weaving
3. Level of service - numbers of lanes, variations in traffic flow
4. Vehicle Speed

3.2 Precipitation Characteristics

Three characteristics of a storm event which may be relevant to the ensuing water quality of runoff from a highway surface are the number of dry days preceding the event, the intensity of the storm, and the volume of the storm-derived runoff. Several studies have attempted to determine the importance of these factors.

3.2.1 Antecedent Dry Period

The number of antecedent dry days before an event affects the runoff quantity from highways (Kent et al., 1982; Lord, 1987), but the evidence pertaining to runoff quality is mixed. Howell (1978a) found a relationship between solids build-up on highway surfaces and the duration of dry weather. Using correlation analysis, Hewitt and Rashed (1992) found an association between the antecedent dry period (ADP) and mean concentrations of dissolved lead, dissolved copper, and particulate-phase lead (significant at the 5% level). However, no correlation for the concentrations of dissolved Cd, particulate-phase Cu, particulate-phase Cd, or individual polyaromatic hydrocarbons (PAH) concentrations was evident. PAH compounds are believed to be lost from the highway surface by volatilization, photo-oxidation, or other oxidation processes.

Colwill et al. (1984) determined that ADP and the traffic flow during that time only affected the concentrations of soluble pollutants. They also found that the concentrations of these pollutants were highest during the initial runoff and declined rapidly. In contrast, the concentration of suspended solids and the total load released were principally influenced by rainfall intensity and the total volume discharged.

Moe et al. (1978, 1982) found that the accumulation of iron, lead, zinc, and airborne particulates was a linear function of ADP. On the other hand, it appeared that the function was curvilinear for solids, sulfates, and some organic indicators.

Other reported studies have found that ADP is relatively unimportant. For example, Horner et al. (1979) found that the correlation was not strong enough to predict TSS loadings from ADP. Kerri et al. (1985) determined ADP to be a poor independent variable for the predictions of Pb, Zn, COD, TKN, or filterable residue. Harrison and

Table 3.3
Results of Correlation Analysis for Peak Pb Concentrations in Runoff Water
(Harrison and Wilson, 1985a)

Relationship	Spearman rank correlation coefficient (r_s)	Significance level
Pb Conc. and ADP	-0.075	
Pb Conc. and peak runoff rate	0.63	0.05
Pb Conc. and runoff in previous 24 h	-0.58	0.05
Pb Conc. and rate of increase in runoff discharge over the time to peak discharge	0.66	0.025

Wilson (1985a) did not find a correlation between ADP and peak lead concentration (Table 3.3), although the negative correlation with discharge in the previous 24 hours reflects the role of runoff in cleansing the road surface.

From these results it can be inferred that rainfall effectively removes pollutants from the road surface and that a short antecedent dry period will result in lower pollutant loads. However, variations in the rate of deposition of pollutants on the road surface and removal processes such as air turbulence (natural or the result of vehicles), volatilization, and oxidation reduce the correlation between pollutant load and longer antecedent dry periods.

3.2.2 Rainfall Intensity

The intensity of the storm can have a marked impact on the type and quantity of pollutants in runoff. This is due in large part to the fact that many pollutants are associated with particles, which are more easily mobilized in high intensity storms. This effect was shown in the work of Hoffman et al. (1985), who graphed rainfall intensity and concentrations of hydrocarbons, lead, and suspended solids (Figure 3.1). Pollutant concentrations generally occurred during high flow rates when transport of contaminant was most efficient. Peaks in pollutant concentrations during lower flow conditions were probably due to reduced dilution during these periods.

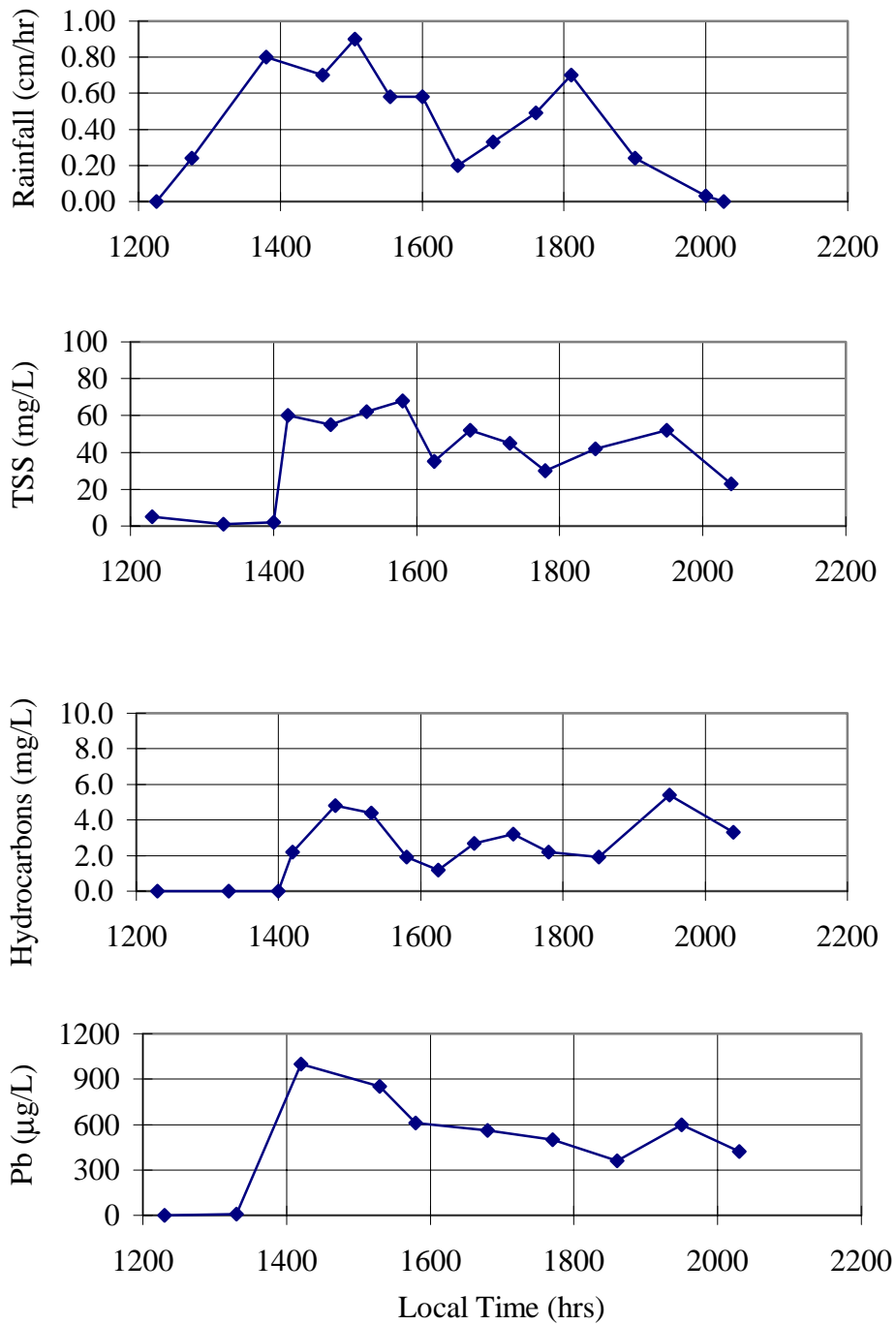

Figure 3.1 Rainfall Intensity and Pollutant Concentrations (Hoffman et al., 1985)

The positive correlation between loading rates and storm intensity was also shown in the work of Horner et al. (1990a). Seven storms were monitored during the winter of 1988-89, and intensities and loading rates were recorded. The ranges of loadings of the two lowest intensity storms (0.026 and 0.020 inch/hour) and the two highest intensity storms (0.119 and 0.114 inch/hour) are compared in Table 3.4. The upper range for all constituents of the higher intensity storms was 2-3 orders of magnitude above the upper range of the less intense storms.

Table 3.4
Ranges of Loadings (1988-89 Storms)
(Horner et al., 1990a)

Storm Type	TSS (mg/h)	VSS (mg/h)	TP (mg/h)	COD (mg/h)	Total Cu (µg/h)	Total Pb (µg/h)	Total Zn (µg/h)
low intensity	7-35,726	2-1631	0.4-31.1	0-920	3-2178	0-354	31-3516
high intensity	436- 14x10 ⁶	136- 322,704	5.8- 10,332.2	0-195,969	121- 362,529	0-175,472	343- 571,527

Ellis and Harrop (1984) found that rainfall intensity was important in explaining a seasonal difference in removal rates of sediment from road surfaces. Higher intensity storms occurring in the summer resulted in increased sediment loadings and particle size ranges.

3.2.3 Runoff Volume

The third precipitation characteristic, the runoff volume, also seems to have little effect on pollutant concentrations but is important in determining the total load to the receiving water. Driscoll et al. (1990c) determined the correlation between runoff volume and eight pollutant concentrations using 184 paired data sets from 23 sites. They found that only 10% of the data sets were significantly correlated at the 95% confidence level, and only 15% were significantly correlated at the 90% confidence level. Furthermore, even for the few sets with significant correlation, the correlations are weak, i.e., on average they explain about 20% of the concentration variability.

Ellis et al. (1984, 1986) monitored a highway catchment with little surface variation, carrying relatively low traffic densities and with minimal alternative land use interferences. They report that total runoff volume and storm duration together explained over 90% of the observed variance in Pb, Cd, Mn, and sediment loadings. Their results demonstrated the lack of importance of antecedent dry days and rainfall intensity in controlling the removal of particulate associated pollutants from this catchment.

Dorman et al. (1988) found that concentrations of runoff pollutants were greater during shorter, low volume storms in which there was no runoff from unpaved areas. Larger storms dilute the highway runoff and lower the concentrations of most pollutants with runoff from unpaved areas.

Even though concentrations are lower, loadings of pollutants are generally greater from longer storms, as the transport of at least some constituents continues throughout the duration of the event. Many solids and other pollutants that accumulate on the pavement and in the gutter between storms are quickly washed off, but vehicles and atmospheric fallout continue to release pollutant constituents (Kerri et al., 1985).

3.3 Highway Surface Type

The type of highway paving materials may also affect the amount of pollutants in highway runoff. Wiland and Malina (1976) measured several parameters in artificial runoff from two highways near Austin, Texas. The data presented in Tables 3.5 and 3.6 show that concentrations and loadings of COD, TOC, lead, and zinc were greater from an asphalt surface than from a concrete surface, even though traffic flow was 160% higher at the concrete paved site. Oil and grease and TSS concentrations and loadings were higher from the concrete surface. Wiland and Malina (1976) attribute this to higher traffic flow, higher abrasiveness of concrete surfaces, and/or guard walls preventing removal of solids by wind.

Gupta et al. (1981c) in a study in Denver, Colorado, determined that oil and grease loadings were highest from an asphalt-paved surface, but concluded that land use was the most important factor in determining runoff quality. Shaheen (1975) investigated

Table 3.5
Average Concentrations (Wiland and Malina, 1976)

Site	Date	Oil and Grease mg/L	COD mg/L	TOC mg/L	Lead µg/L	Zinc µg/L	TSS mg/L
IH 35 (concrete)	Feb. 11	6.8	117	18	229	75	--
	Mar. 15	3.2	169	9	98	60	--
	Apr. 22	2.1	76	17	137	95	--
	Jun. 16	3.3	128	28	366	165	79
	July 21	4.3	92	23	308	75	80
	Aug. 6	7.8	167	47	423	278	171
	Average	4.6	125	24	259	125	110
	MoPac (asphalt)	Feb. 11	3.4	266	66	581	406
Mar. 15		2.3	205	22	113	62	--
Apr. 22		1.4	116	30	101	83	--
Jun. 16		2.2	280	70	527	362	44
July 21		2.1	104	35	219	104	40
Aug. 6		4.6	568	141	1098	970	50
Average		2.7	257	61	440	331	45

Table 3.6
Mass Loadings (Wiland and Malina, 1976)

Site	Date	Oil and Grease mg/sq ft	COD mg/sq ft	TOC mg/sq ft	Lead µg/sq ft	Zinc µg/sq ft	TSS mg/sq ft
IH 35	Feb. 11	5.4	92	14	181	59	--
	Mar. 15	7.3	387	20	224	137	--
	Apr. 22	4.8	175	39	303	218	--
	Jun. 16	7.6	295	64	839	378	181
	July 21	6.0	130	33	436	106	113
	Aug. 6	11.9	255	72	646	424	261
	Average	7.2	222	40	438	220	185
	MoPac	Feb. 11	2.4	187	47	407	285
Mar. 15		2.9	259	27	142	79	--
Apr. 22		1.7	147	38	127	105	--
Jun. 16		2.8	353	89	664	457	56
July 21		4.5	225	76	475	226	86
Aug. 6		10.0	1229	304	2374	2098	108
Average		4.1	400	97	698	542	83

roadway abrasion as a source of pollutants, but showed that for smooth streets in good repair, the contributions are insignificant compared to that due to traffic activities and erosion of local soil. Driscoll et al. (1990c) also reported that highway surface type was unimportant compared to other factors.

Saylak et al. (1980) evaluated a number of sulfur-asphalt and sulfur-concrete paving systems to assess their potential environmental impact. They found that exposure to the elements had a negligible effect on these materials, and that runoff produced little or no effect on the immediate environment.

Stotz (1987) investigated differences in paving materials in a study of three German highways, but found that drainage methods were more important than pavement type in determining the quality and quantity of highway runoff. Two of the highways had an impermeable system of curbs and stormwater sewers exclusively; on the third site (Ulm-West), three-quarters of the catchment area was drained through grass-covered ditches. Although traffic loads and precipitation values at the three sites were similar, runoff volumes were quite different. Runoff at the Ulm-West site was 178 cubic meters/hectare/month compared to values of 599 and 358 from the other highways.

Yearly pollutant loads are shown in (Table 3.7) and indicate that the loads were smaller for the Ulm-West highway for all of the constituents except chlorides. The higher chloride concentrations were most likely due to salt in thawing ice. Loadings from the other two highways were very similar, even though one highway was concrete (Pleidelsheim) and one was asphalt (Obereisesheim). The effect of drainage through grass-covered ditches is discussed in detail in the section on vegetative controls for runoff treatment.

3.4 Pollutant Characteristics

The concentrations and behavior of pollutants in runoff depend to a large extent on whether the pollutants are in dissolved or particulate form. Existing data indicate that large fractions of heavy metals, oil and grease, TOC, and COD are attached to solid particles and that concentrations are generally higher in the smaller size fractions (Revitt and Ellis, 1980; Sartor and Boyd, 1972, 1973; Pitt, 1979; Pitt and Amy, 1973; Wilber and

Table 3.7
 Yearly Pollutant Loads in Highway Surface Runoff (in kg/hectare)
 (Stotz, 1987)

	A81 Pleidelsheim	A6 Obereisesheim	A 8/B 10 Ulm-West
Paving Material	concrete	asphalt	asphalt
% of Drainage Area Paved	100	86	40
Filterable solids	873	848	479
COD	672	557	207
Mineral Oil	43.27	27.09	4.85
PAH	0.018	0.014	0.005
Cd	0.037	0.029	0.0072
Cr	0.062	0.100	0.012
Cu	0.621	0.544	0.130
Fe	23.37	28.81	4.37
Pb	1.332	1.155	0.360
Zn	2.329	2.892	0.715
Cl	1011	777	1344
Ammonia	4.60	3.22	1.03
TP	1.62	1.45	0.63

Hunter, 1979). Particle size distributions for solids collected on road surfaces have been described by Pitt (1979) and Butler et al. (1992). The size of the particulates is very significant in the transport of the associated pollutants. Finer grains have lower settling velocities and remain in runoff longer than larger grains. In addition, a “first flush” effect is often seen for the dissolved components, whereas, the particle-associated elements show a more complex temporal variation related to storm intensity and the flushing of large-grained sediment through drainage systems (Harrison and Wilson, 1985a).

Metals are predominantly washed from highways after adsorption upon particulate materials such as bituminous road surface wear products, rubber from tires, and particles coated with oils. The degree of association with solids varies between different metals. Gupta et al. (1981c) found dissolved metal fractions in runoff were small for lead, zinc, and iron (Table 3.8). Lead values in particular were small and often below detectable limits of 0.05 mg/L. Metal loadings were tested for statistical correlation with solids loadings. Lead was significantly correlated with solids at a 99% confidence limit for six out of six sites. Zinc, iron, and cadmium were correlated at five of the six sites, copper and chromium at four sites, and mercury at only one (Gupta et al., 1981c).

Table 3.8
Concentration of Total and Dissolved Lead, Zinc, and Iron at Various Sites
(Gupta et al., 1981c)

Site	Storm No.	Type of Sample	Lead (mg/L)		Zinc (mg/L)		Iron (mg/L)	
			Total	Dissolved	Total	Dissolved	Total	Dissolved
I-794 Milwaukee	11	Composite	13.1	<0.05	3.4	0.21	43.0	0.03
		Discrete	160.0	<0.05	25.0	0.58	39.0	0.48
		Discrete	17.0	<0.05	3.3	0.20	52.0	0.09
		Discrete	2.5	<0.05	0.8	0.31	10.0	0.08
		Discrete	0.2	<0.05	0.1	0.09	0.4	0.07
Hwy. 45 Milwaukee	17	Composite	6.6	<0.05	1.9	0.36	35.0	0.11
		Discrete	8.6	<0.05	2.8	0.25	43.0	0.12
		Discrete	9.3	<0.05	3.0	0.29	51.0	0.14
		Discrete	2.3	<0.05	1.2	0.48	14.0	0.20
Hwy. 45 Milwaukee	18	Composite	2.2	<0.05	0.94	0.39	15.0	0.23
		Discrete	6.5	<0.05	2.35	0.33	39.0	0.13
		Discrete	6.4	<0.05	2.00	0.37	34.0	0.24
		Discrete	0.1	<0.05	0.35	0.34	1.1	0.16
Grassy Site Milwaukee	01	Composite	<0.05	<0.05	0.14	0.08	2.5	0.25
		Discrete	0.20	<0.10	0.16	0.08	3.6	0.19
		Discrete	0.40	<0.10	-	-	2.1	0.20
		Discrete	<0.10	<0.10	-	-	1.5	0.15
I-81 Harrisburg	15	Composite	<0.05	<0.05	0.15	0.02	6.6	0.13
		Discrete	<0.05	<0.05	0.09	0.08	1.9	0.05
I-40 Nashville	03	Discrete	2.0	<0.05	1.10	0.20	27.0	0.05
I-40 Nashville	04	Composite	0.5	<0.05	0.36	0.03	6.3	0.34
		Discrete	2.2	<0.10	1.30	0.16	32.0	0.43
		Discrete	0.8	<0.10	0.40	0.14	7.9	0.04
		Discrete	0.3	<0.10	0.19	0.01	3.7	0.05

Hewitt and Rashed (1992) also report that lead is the metal most associated with particulates. The particulate fractions for lead, copper, and cadmium in their study were respectively 90%, 75%, and 57%. Bourcier and Hinden (1979) also report that total metals exist primarily in the settleable fraction with only a small percentage in the dissolved-colloidal fraction. Bourcier et al. (1980) found no detectable dissolved-colloidal fractions for either titanium or tungsten. A linear relationship was observed

between total solids and the individual metal concentrations, with titanium showing a higher correlation than did tungsten.

Harrison and others (Harrison and Wilson, 1985a,b,c; Harrison and Johnston, 1985; Harrison et al., 1986) have studied and discussed the behavior and associations of metals at length. Using geometric regression, Harrison and Wilson (1985a) found significant correlations of suspended solids with lead and iron. Manganese was found predominantly in the dissolved phase, while copper and cadmium exhibited intermediate behavior (Harrison and Wilson, 1985a). Since metal concentrations are associated with different sized particulate materials, they do not always follow the suspended sediment profiles exactly. Speciation of trace metals in freshwater samples is an especially difficult task. Laxen and Harrison (1981) described a scheme based on size fractionation with subsequent application of a range of techniques to overcome this problem.

Most metals are found in the finer street dust (<43 μm). Although fine street dusts constitute 6% of the total mass of solids, they contain more than 50% of the trace metals. Because storms and runoff can more easily mobilize the smaller grains, metal concentrations in suspended sediment are generally higher than in street dust (Harrison and Wilson, 1985b).

Other pollutants found primarily in the particulate phase and/or showing a strong correlation with solids include PAH's, TOC, COD, and extractable organics. Although particulate and dissolved phase concentrations of PAH's were not separately determined by Hewitt and Rashed (1992), the similarity between concentration profiles of PAH's and suspended solids implies that all of the PAH compounds tend to be adsorbed to particles. Chui et al. (1981) found high degrees of correlation ($R > 0.83$ in all but one case) between solids and TOC and COD regardless of traffic or weather conditions.

Table 3.9 (Zawlocki et al., 1980) shows the phase concentrations in highway runoff for nine categories of extractable organics. For all three major classes (aromatic compounds, aliphatic hydrocarbons, and oxygenates) and all three storms, the majority of pollutants are found in the particulate phase. The lowest particulate/total ratio is 54% for aliphatic hydrocarbons during the first storm. Most of the ratios are over 90%.

Table 3.9
Extractable Organics in Runoff Classified into Nine Categories
 (Zawlocki et al. 1980)

Class of Compounds	Storm 1-5-87			Storm 1-5-131			Storm 520-43		
	Particulate (µg/L)	Soluble (µg/L)	Total (µg/L)	Particulate (µg/L)	Soluble (µg/L)	Total (µg/L)	Particulate (µg/L)	Soluble (µg/L)	Total (µg/L)
Alcohols	T	160	160	478	155	633	327	126	453
Aliphatic Hydrocarbons	3710	3220	6930	1850	636	2490	913	20	933
Aromatic Compounds Including Heterocyclics	2050	148	2200	297	96	393	596	128	724
Halogenated Organics	T	T	T	175	9	82	114	T	114
Ketones and Aldehydes	1130	T	1130	87	39	126	385	128	513
Organosulphur Compounds	1200	62	1260	T	5.3	5.3	4.9	T	4.9
Oxygenates excluding alcohols, phenolics, ketones/aldehydes	3170	410	3580	3510	228	3740	2440	126	2570
Nitrogen containing Compounds	1420	62	1480	87	28	115	325	135	460
Phenolics	2830	80	2910	T	2.9	2.9	T	T	T
Total Chromatographed	10236	6803	17039	6308	1204	7512	4083	320	4403

Nutrients are more likely than metals, PAH's, TOC, COD, or extractable organics to be found in the dissolved rather than in the particulate phase. Gupta et al. (1981c) Zawlocki found significant correlations between total solids and TKN at only two out of six sites. The parameter nitrate plus nitrite showed very weak correlation with TSS in highway runoff (Chui et al., 1981). Approximately 79% of organic phosphorus was found in the dissolved phase (Hvitved-Jacobsen et al., 1984). Major ions also are found predominantly in dissolved form. Harrison and Wilson (1985a) found that particulate fractions ($< 0.45 \mu\text{m}$) often constituted less than 1% of total concentrations of Na^+ , Ca^{2+} , Cl^- , and SO_4^{2-} . Two ions (K^+ and Mg^{2+}) were associated with particulate fractions, but their total concentrations were low ($< 8 \text{ mg/L}$). Organic lead also tends to be primarily dissolved.

Higher concentrations of pollutants are often observed in the first runoff from a storm, and this is especially true for dissolved components. This phenomenon is commonly described as the “first flush,” and has lead many agencies to require retention and treatment of the first 1/2 inch of rainfall. Howell (1978) reported higher concentrations of metals and nutrients during the initial 30 to 60 minutes of a runoff event. Horner et al. (1979) found concentrations to be higher in both magnitude and

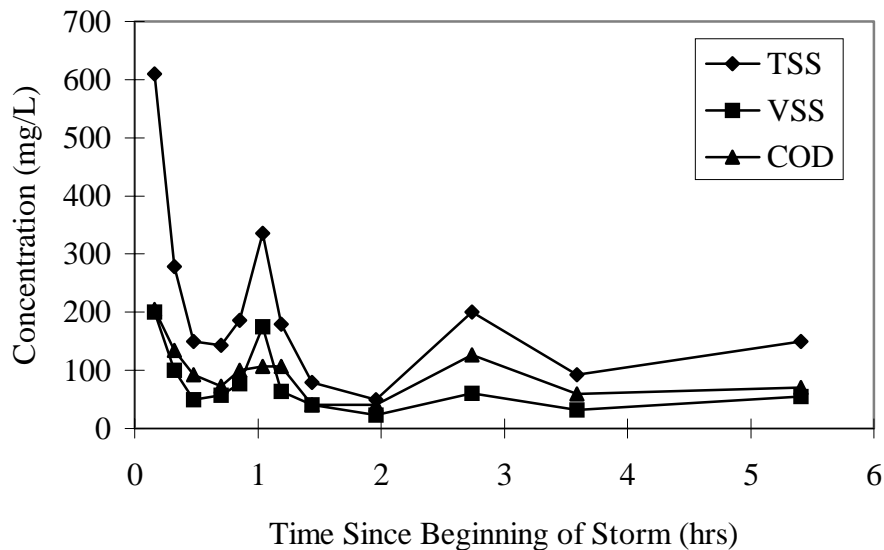

Figure 3.2 FirstFlush for Solids and COD (Horner et al., 1979)

fluctuation during the first 30 to 60 minutes of a runoff event. Concentration profiles for TSS, VSS, and COD are presented in Figure 3.2. A “firstflush” is evident for both measurements of solids.

Other studies have documented the first flush phenomenon for dissolved constituents only. Concentration profiles for particle-associated pollutants often display a discharge pattern more complex than a simple “first-flush.” In a study of a major rural highway in northwest England, Hewitt and Rashed (1992) observed a rapid, steady decline in concentrations of organic lead compounds, dissolved cadmium, and (to a lesser degree) dissolved copper (Figure 3.3); however, concentrations of suspended solids and particulate-associated metals fluctuated with the runoff hydrograph.

Harrison and Wilson (1985a) also reported a “first-flush” for dissolved constituents, but found that the temporal variation of concentrations of particle-associated elements was more complex and was related to rainfall intensity and the flushing of sediment through the drainage system. The work of McKenzie and Irwin (1983) produced similar results.

Spangberg and Niemczynowicz (1992) measured rainfall, runoff, turbidity, pH, conductivity, and temperature on a simple urban catchment with a 10 second time resolution. The first flush phenomenon was clearly documented at this location. They found that a significant part of the washoff occurs during the initial stage of the runoff process, just before the runoff peak, and is strongly correlated to the rainfall intensity.

Balades et al. (1984) found that 80% of COD, TSS, and lead were eliminated by the first 52% of runoff. On the other hand, it took more than 60% of the runoff to discharge 80% of the load of zinc, and more than 70% to eliminate 80% of the hydrocarbon load.

The first flush phenomenon was also investigated by Pope et al. (1978). They found that TDS and heavy metals exhibit a definite first flush characteristics. The highest percentages of total PAH found in solution were observed during the beginning of the storm.

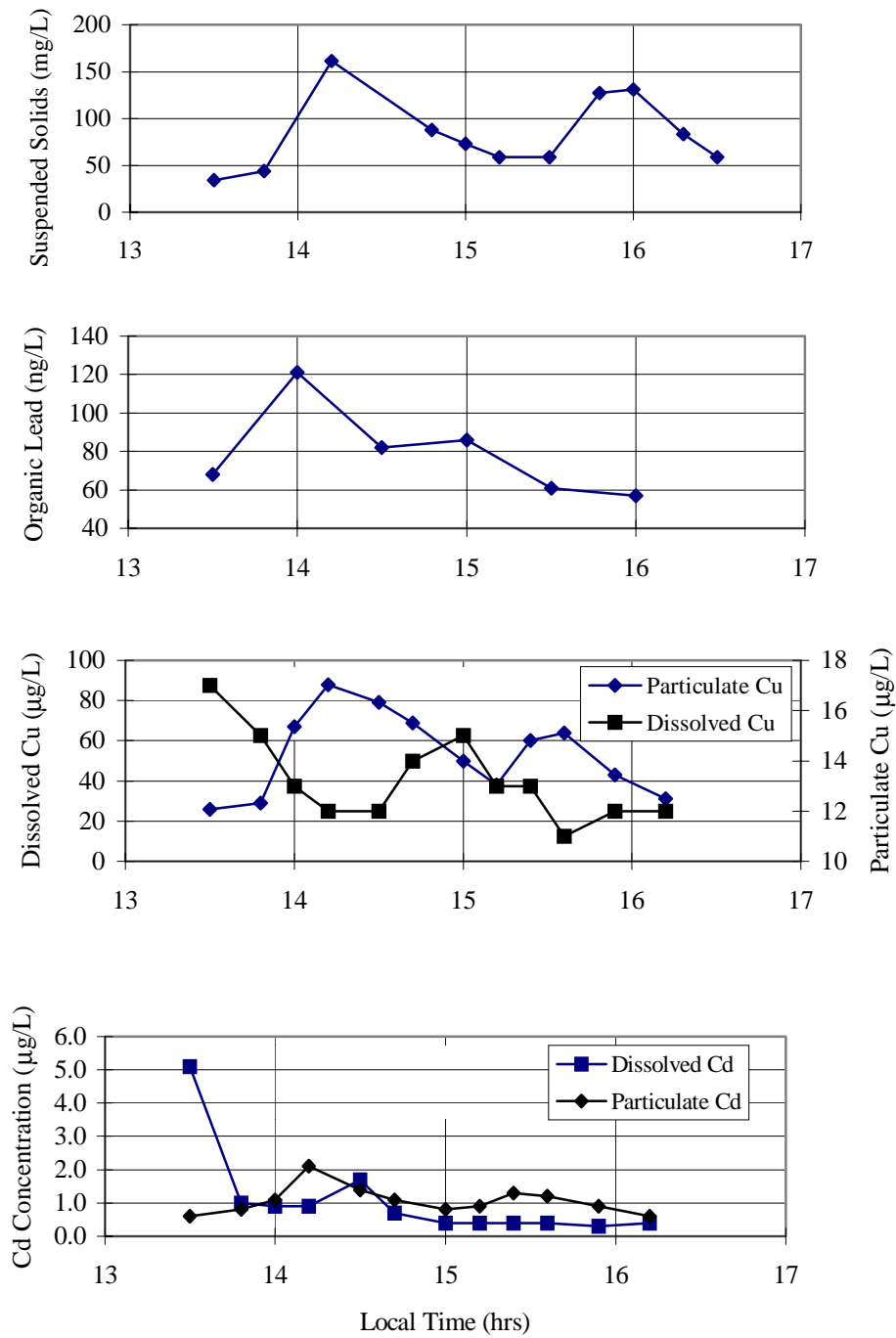

Figure 3.3 Concentration of Particles and Particulate Associated Metals (Hewitt and Rashad, 1992)

Harrison and Wilson (1985a) demonstrated a positive correlation between Pb concentration and two factors: peak runoff rate and the increase in runoff discharge during the rising limb of the hydrograph (Table 3.3). These factors are indicators of high-intensity storms. Such storms exhibit the vigorous flushing required to remove the mostly particle-associated lead.

3.5 Surrounding Land Use and Seasonal Considerations

Driscoll et al. (1990c) reported that surrounding land use is the most important general factor influencing pollutant loads in highway runoff. They found significant differences in highway runoff quality between urban areas and in rural areas. Although traffic densities are markedly different between these two categories of land use, there was no clear correlation with ADT within each grouping. This leads to the conclusion that atmospheric quality differences between urban and rural areas is the most important influence. Unusual local factors can also influence the quality of runoff. Examples include the high zinc concentration in runoff at a site adjacent to a smelter (Driscoll et al., 1990c; Chui et al., 1981) and high solids loading resulting from the eruption of Mount St. Helens (Asplund et al., 1980; Chui et al., 1981).

Ranges of pollutant concentrations and loads also can be attributed to seasonal variations. The use of studded tires (Chui et al., 1981) and the use of salt or sand for deicing (Gupta et al., 1981c; Harrison and Wilson, 1985a) increase solids loading. Use of studded tires in winter can also result in higher loads of tungsten and titanium (Bourcier et al., 1980). Deicing is an important source of constituents other than solids. Kobriger and Geinopolos (1984b) found high correlations between metals, especially lead, zinc, iron, and saltating particulates. Increase in chloride concentration and conductivity due to the application of road salt on highways was also discussed and measured by Stotz (1987) and Besha et al. (1983).

Other site-specific or seasonal factors can outweigh the impact of sanding. Horner et al. (1979) found spring loads to be greater than winter loads (despite sanding in winter) due to the less-frequent rains and the increased construction activity in the spring.

4.0 EFFECTS OF HIGHWAY RUNOFF

The type and size of the receiving body, the potential for dispersion, the size of the catchment area, and the biological diversity of the receiving water ecosystem are just some of the factors that determine the extent and importance of highway runoff effects.

Hydrological effects of highways are highly site specific. The extent of increased storm runoff volumes and peak discharges due to increased impervious cover depends on the relative sizes of highway right-of-way and total watershed area. Most highway projects are not large enough to create significant downstream flooding. A more likely problem is increased stream bank erosion due to the increased peak flows (Dupuis and Kobriger, 1985c). Hollis and Ovenden (1988) analyzed the variations in stormwater quantity from roads due to seasonal effects as well as rainfall characteristics. Methods of predicting the hydrologic effects of highways bridges and encroachments on surface waters were presented by Richardson (1974).

Highways also may cause hydrogeologic effects (Parizek, 1971). These effects include the beheading of aquifers, the development of groundwater drains where cuts extend below the water table, changes in groundwater and surface water divides and basin areas, obstruction of groundwater flows by abutments, retaining walls, and sheet pilings, and changes in runoff and recharge characteristics.

Like hydrological effects, water quality effects of highway runoff are site specific. Different types of water bodies react differently to the loading of pollutants. The processes controlling the transport and fate of pollutants in lakes and reservoirs differ from those in rivers, streams, and aquifers. Lakes respond to cumulative pollutant loads delivered over an extended period and are usually analyzed on an annual or seasonal basis. Since the most common environmental issue in lakes is the overstimulation of aquatic life, nutrients are the pollutant types of greatest significance. On the other hand, streams respond to individual events, since runoff produces a pulse of contaminant which moves downstream and is well removed by the time the next storm occurs. In general, the most common concern in streams is suppression of aquatic life by toxic effects of heavy metals (Driscoll, 1990c). The relative size of the receiving water determines the

amount of dilution of highway runoff and related pollutants. In addition, the type of water body and its designated beneficial use determine which sets of pollutants will have the most significance.

Seasonal variations in the water quality of both lentic and lotic systems can influence the impact of highway runoff (Dupuis and Kobriger, 1985c), and the size of a receiving water is also a consideration. Lange (1990) theorized that highway runoff is a problem for watercourses with catchment areas less than 5 km² but can be discounted for watercourses with catchment areas greater than 20 km². The effects of dilution of bridge runoff by the James River was estimated by Zellhoefer (1989).

The potential impacts of various pollutants have been discussed by Dupuis and Kobriger (1985c), Dorman et al. (1988), and McKenzie and Irwin (1983). Particulates and sediment in runoff also can cause problems by decreasing flow capacity in drainage ways, reducing storage volume in ponds and lakes, smothering benthic organisms, decreasing water clarity, and interfering with the respiration of small fish. Furthermore, toxic materials often are sorbed to and are transported by suspended solids. These toxins include metals, hydrocarbons, chlorinated pesticides, and PCB's, and they present acute and chronic threats to receiving water organisms.

Ellis et al. (1987) report that the majority of toxic materials entering surface runoff are inert, occurring in association with inorganic particles or rubber, bitumen, and other organics found on road surfaces. Once this material is entrained during a storm event and removed from the surface, considerable phase transformations can occur which affect pollutant form and strength. Morrison et al. (1990, 1988) report that bacterial activity and acid dissolution produce increases in dissolved metal in the storm sewer system. The resulting stormwater contains dissolved ionic forms of Cadmium and Zinc, which are directly toxic.

Researchers generally agree that nutrients (various forms of nitrogen and phosphorus) are a concern because of the long-term potential for eutrophication and the short-term problem of "shock-loading." Oxygen-demanding materials (measured by COD or BOD) can be relatively high in concentration, although the organics are usually

particulate-associated and may settle rapidly before the demand can be exerted. Furthermore, DO depletion can be compensated by reaeration during stormflow periods.

Relatively high levels of pathogenic bacteria of non-human origin can be detected in runoff from highways, that routinely are used to haul livestock and/or are subjected to large amounts of bird droppings.

Effects of stormwater runoff from highways have been studied and quantified for three categories of receiving waters: streams, rivers, and lakes; wetlands; and groundwater and soil-water.

4.1 Biological Effects and Toxicity Testing

Since full-scale biological surveys to determine the effects of highway runoff are often difficult and costly, bioassays using environmental samples are often preferred. In addition, bioassays integrate the effects of all toxicants contained in a sample and can indicate toxicity even where concentrations of priority organic pollutants do not exceed EPA criteria levels (Peterson et al., 1985). Bioassay tests of organisms from streams and lakes receiving highway runoff generally have not demonstrated acute toxicity, although site specific conditions may produce a toxic response.

Dupuis et al. (1985a) reported that runoff from highways with various traffic densities (12,000 to 120,000 ADT) had little effect on the biota of receiving waters. Flow-through in situ bioassay studies at a lake site did not indicate an impact on six species of invertebrates. Bioassay testing included sampling for benthic macroinvertebrates and macrophytes. The data show that highway runoff had little or no influence on cattails.

Acute toxicity tests, using runoff from a period of snow melt, on heterotrophic organisms (bacteria, fungi, protozoa), on algae, fish, and fish eggs did not show any negative effects on growth or behavior (Gjessing et al., 1984a). Heterotrophic organisms were stimulated by the runoff water at the maximum concentrations tested (90%), and neither the fish eggs or one-year-old salmon appeared to be affected by undiluted runoff water. Potential chronic effects and the bioaccumulation potential were not evaluated in this study.

Five 12-day bioassays were conducted by Kszos et al. (1990) to evaluate the toxicity of runoff from a bridge to young-of-the-year bluegill sunfish. One bioassay used fall runoff, two used winter runoff, and one used spring runoff. He found that survival rates of the sunfish exposed to 1%, 10%, and 25% concentrations of spring runoff were similar to survival rates in lake water. Fish exposed to the 25% concentration of fall bridge runoff and to the 50% concentration of fall and spring runoff had significantly greater survival rates than their respective controls. For bioassays conducted with winter runoff, the sunfish exposed to 50% runoff had significantly lower survival than controls, but fish in the 1%, 10%, and 25% runoff did not. The concentration of NaCl in the winter runoff was high enough to account for most of the observed toxicity.

The effects of runoff from highway surfaces and cut slopes on the primary productivity of algae were studied by Winters and Gidley (1980). They measured the response of indigenous algae to various levels of runoff with a 5-day bioassay using the carbon-14 method. They found that runoff could be either stimulatory to algal growth or, in cases where the runoff came from heavily used highways, mildly to severely inhibitory. The nutrient load in runoff was generally stimulatory, but the concentration of metals dictated the final bioassay results.

Portele et al. (1982) found that the growth rate of the algae *Selenastrum capricornutum* was reduced as the ratio of highway sample to dilution water increased. Stormwater enriched with nutrients to levels equivalent to controls consistently demonstrated greater than 85% inhibition of maximum algal biomass. They also found that rainbow trout exposed to filtered stormwater showed no harmful effects in a 4-day exposure. Bioassays conducted with unfiltered samples resulted in significant mortalities in both 50% and 100% dilutions. The clear implication was that either the particulates present in the samples or the pollutants associated with the solids were responsible for these deaths. The suspended solids levels observed were lower than values normally considered as harmful to fish, but this study incorporated fish at life stages earlier than those used in other studies. Portele et al. (1982) also documented significant differences in the toxicity of the runoff from two similar highway sites in Seattle.

Yousef et al. (1985d) demonstrated that hardness, alkalinity, and organic complexes reduced the toxicity of Cd, Zn, Pb, and Cu in natural water. They compared the toxicity of copper to mosquito fish (*Gambusia affinis*) in water from a retention pond receiving highway runoff to the toxicity of copper in deionized tap water. The concentration resulting in 50% mortality of test subjects with pond water was about 50 times higher than with tap water.

The effect of rural highway runoff on benthic macroinvertebrate abundance and composition was studied by Smith and Kaster (1983). They found that numbers and biomass of organisms were higher at a site receiving highway runoff than at the control site. Another station receiving intermediate amounts of highway runoff had similar annual mean numbers and biomass as the control. Their study suggested that roadways with light traffic density (7000-8000 vehicles per day) have only a minimal effect on macroinvertebrate populations.

Stream sediments store heavy metals and are the primary source for the bioconcentration of metals (Van Hassel et al., 1980). Concentrations of lead, zinc, nickel, and cadmium in the water columns of streams near highways with low to moderate traffic volumes (around 15,000 ADT) were comparable to concentrations in uncontaminated waters. However, the dry weight concentrations of metals in benthic insects and fish were comparable to values reported in the literature for animals from contaminated waters. This suggests that the accumulation of metals in the bed sediments is important in the bioaccumulation of metals.

Madigosky et al. (1991) measured the concentration of Pb, Cd, and Al in tissues of crayfish *Procambarus clarkii* from several wetland sites located adjacent to highways and in a control population. Their results indicated that levels of contamination obtained in almost all tissues of crayfish from roadside ditches contained significantly higher amounts of metals than the control group. Since thousands of kilograms of crayfish are harvested annually from these areas and are used for human consumption, the potential accumulation of trace elements in their tissues may pose a health threat to predators, including man.

Similar concerns were voiced by Birdsall et al. (1986) about lead concentrations in tadpoles inhabiting highway drainages. They found that lead concentrations in sediment and in two species of tadpoles were positively correlated with average daily traffic volume. Lead concentrations in the sediment were usually 4 to 5 times higher than in the tadpoles, suggesting that the greatest hazard is posed to benthic species of fish rather than to pelagic species, whether or not the latter consume contaminated tadpoles.

Cadmium, lead, nickel and zinc have also been shown to accumulate in earthworms along highways (Gish and Christensen, 1973). They found that concentrations decreased as distance from the roadway increased. Earthworms accumulated up to 331.4 ppm of Pb and 670.0 of Zn, concentrations which may be lethal to earthworm-eating animals.

The effects of highway runoff on the ecology of stream algae were documented by Dussart (1984). He found increases in number of algae, algal abundance, species diversity, and in the relative abundance of filamentous organisms downstream of the highway. These effects were apparently the result of highway runoff acting as a source of nutrients in an upland, nutrient poor area.

The effects of using herbicides to control vegetation were investigated by Kramme and Brosnan (1985a). Two sites were monitored in the herbicide study; one was treated with 2,4-D and the other with picloram. Although these chemicals were detected in the runoff following treatment, the concentrations were below those estimated to impact aquatic life. Bioassays were conducted with the runoff, and no significant effects on the growth of hypocotyl were detected.

Kramme and Brosnan (1985a) also investigated the effects of surface treatment (seal coating) on runoff quality. An asphalt roadway located in a rural area was treated with an asphalt emulsion and limestone gravel. Three runoff samples were collected following treatment and analyzed for PAH. No PAHs were measured in the runoff at a detection limit of 3 µg/L, and the samples were relatively nontoxic as demonstrated by the low mortality of *Daphnia magna* in static bioassays.

4.2 Streams, Rivers, and Lakes

Metal loadings to receiving waters are of particular concern due to the potential toxicity and relative abundance of metals in highway runoff. Yousef et al. (1982) found significant differences (often at greater than 95% confidence levels) between metal concentrations in Lake Lucien, a relatively undeveloped lake, near Orlando, Florida, and metal concentrations in a nearby highway runoff detention pond. The analysis included sampling of both the water column and bed sediments. Pertinent data are included in Tables 4.1 and 4.2. Some metal concentrations reached significantly higher levels in the

Table 4.1
Significance of Differences in Heavy Metal Concentrations in Water Samples
from Maitland Interchange
(Yousef et al., 1982)

Element	Total		Dissolved		Confidence Level (%)	
	Lake Lucien	West Pond	Lake Lucien	West Pond	Total	Dissolved
Zn	56	64	34	43	45.9	75.6
Pb	33	92	19	66	99.9	98.6
Cr	8.6	17	5.4	7	94.9	70.4
Ni	7.3	15	3.4	5	80.8	53.6
Ca	36	38	19	21	29.2	34.9
Fe	182	414	82	128	98.4	52.4

Average concentrations in $\mu\text{g/L}$

Table 4.2
Significance of Differences in Heavy Metal Concentrations in Bottom Sediments from
Maitland Interchange (t-test analysis)
(Yousef et al., 1982)

Element	Lake Lucien	West Pond	Confidence Level (%)
Zn	21.1	35.2	80.27
Pb	3.4	76.0	97.51
Cr	2.5	33.9	98.87
Ni	1.2	10.7	97.64
Cu	5.0	15.2	93.17
Fe	421.4	3264.7	98.62
Cd	0.1	0.7	96.05

Mean dry weight ($\mu\text{g/g}$)

detention pond. Lead concentrations in the water column were almost three times as high in the pond as in the lake, but total zinc concentrations in the pond were almost identical to those in Lake Lucien.

The effects of highway runoff were more dramatic in the sediments. Concentrations in pond sediments were 1.7 to 22 times higher than concentrations in lake sediments. Metal enrichment (2 to 4 times "normal" levels) also was observed in a small lake catchment area of 2.4 km² near Oslo, Norway, despite a traffic density below 20,000 ADT (Gjessing et al., 1984b). Yousef et al. (1984) recommended directing bridge drainage towards retention/detention ponds or floodplains to minimize potential accumulation of metals in sediment and biota of receiving waters.

Dilution of metals concentrations was shown by Wanielista et al. (1980) by comparing concentrations in runoff from a highway bridge equipped with scupper drains and concentrations in water samples taken from the lake itself (almost directly underneath the bridge). Table 4.3 shows a range of dilution ratios. Lead is diluted the most. The runoff concentration of lead is more than 20 times greater than the lake concentration. The fact that copper and chromium concentrations are greater in the lake indicates that other pollutant sources are present.

Table 4.3
Comparison Between Total Metal Concentrations in Bridge Runoff
and Lake Ivanhoe Water Samples
(Wanielista et al., 1980)

	Zn	Pb	Ni	Fe	Cu	Cr	Cd	As
Average concentration in lake	104	75	15	192	74	14	4	57
Average concentration in runoff	498	1558	53	2427	52	11	5	58
Runoff/lake ratio	4.7	20.8	3.5	12.6	0.7	0.8	1.3	1.0

Concentrations in µg/L

Beaven and McPherson (1978) sampled water, sediment, and aquatic plants from ponds receiving runoff from a major highway interchange. They found that concentrations of constituents were generally within the range expected in an uncontaminated environment. Concentrations of chromium (20 µg/L) in pond water and lead (500 µg/g), dieldrin (22 µg/kg), and polychlorinated biphenyls (53 µg/kg) in bottom sediment did exceed ambient levels. Ten metals were detected in cattail and algal samples but only iron, manganese, and zinc occurred in higher concentrations there than samples taken from the bottom sediment.

The type of drainage from a highway bridge can influence runoff quality and subsequent effect on receiving water. Yousef et al. (1982) compared concentrations of lead, zinc, chromium, nickel, copper, and iron in sediments beneath highway bridges with and without scupper drains. On the bridge without scuppers, water drains toward the adjacent land on either side of the lake. The data show that sediment metal concentrations were two to three times greater beneath the bridge with scuppers.

Dupuis et al. (1985a) studied several highways a wide range of traffic densities between (12,000 and 120,000 ADT). Lead was the only parameter in the water column even slightly affected by runoff, with maximum concentrations at two of the three influenced stations in excess of 0.20 mg/L, while concentrations of lead at the control stations never exceeded 0.05 mg/L. Metal concentrations in the sediments showed little difference between the control and influenced stations.

Solids, pH, sulfate, turbidity, TOC, oil and grease, COD, nutrients, sodium, chloride, alkalinity, specific conductivity, calcium, indicator bacteria, and TKN concentrations also were measured in the sediments. TKN concentrations were higher for the highway influenced stations at only one of the sites. During the August survey, concentrations at the control station were always below 1500 mg/kg dry weight, while concentrations at the influenced stations were almost always above 2000 mg/kg and ranged as high as 4000 mg/kg.

The toxic effects of metals in highway runoff can be greatly reduced by natural processes within the receiving water. Yousef et al. (1985a) described how ionic species of incoming trace metals are reduced by complexation. Lead often exists as $PbCO_3$, and

much of the copper is associated with organic complexes. Most of the metal species in runoff eventually reside in the top few centimeters of the sediment and are unlikely to be released to the water column under aerobic conditions.

Harned (1988) described the effects of highway runoff on streamflow and water quality in rural area of North Carolina. He found that during storm runoff, streamflow in basins traversed by a highway rose and fell more rapidly than that in undeveloped basins. The runoff had little or no effect on suspended sediment, water temperature, dissolved oxygen, and pH. The highway runoff also did not consistently increase heavy metal concentrations.

The accumulation of heavy metals in the sediment of roadside streams was investigated by Mudre and Ney (1986). They found that metals concentrations at sites receiving highway runoff had two to five times the concentrations of upstream sites. However, three of the six streams monitored did not demonstrate this pattern. The interstream variation was more strongly related to distance of the stream from the road surface, stream velocity, and organic content of the sediment than to traffic volume. Precipitation volume was found to affected the upstream/downstream ratio.

4.3 Wetlands

Schiffer (1988) studied the effects of highway runoff on two wetlands in central Florida. Highway runoff was compared to state water quality standards for alkalinity, trace metals, phosphate, total phosphorus, specific conductivity, pH, ammonia, ammonia plus organic nitrogen, nitrate plus nitrite, TOC, DO, and temperature. Lead concentrations exceeded state standards in 43% of the samples from one wetland inlet. In another wetland, lead exceeded state standards in only 19% of inlet samples, while zinc surpassed the standard in 81% of inlet samples.

Areal variations within the wetlands also were studied. Most constituent concentrations such as nutrients, aluminum, lead, zinc, specific conductivity, and pH decreased with distance from the inlets; however, color, TOC, and chromium concentrations sometimes increased with distance. Schiffer (1988) suggested possible explanations for the results obtained for chromium; this explanation was based on

chromium remaining dissolved longer than other metals and/or atmospheric sources of chromium.

Mitigation and enhancement of wetlands following highway construction were discussed by Thrasher (1983). Factors that limit the success of wetland establishment projects include improper final grade, improper wetland species, inadequate water level, erosion, and litter deposition and accumulation.

4.4 Groundwater and Soil-water

Researchers agree that highway runoff can have a significant impact on the hydrogeologic environment, including changes in water quality in the vadose and saturated zones. Many of these changes are associated with stormwater runoff controls.

McKenzie and Irwin (1988) observed the effects of two types of runoff control devices on the water quality in an underlying surficial aquifer that is a major source of drinking water in southern Florida. The two types of controls evaluated were exfiltration trenches and grassed swales, which received parking lot and roadway runoff. The exfiltration trench is essentially like an infiltration trench, except that the runoff collects first in an open trench, and then drains through a perforated pipe drain to an adjacent underground reservoir that is filled with coarse aggregate and topped with pea gravel, filter fabric, and native soil. The reservoir is partially within the water table.

McKenzie and Irwin (1988) used the statistical non-parametric analysis of variance technique to evaluate the 11 water quality variables measured over a 1-year period at the structures and at nearby groundwater monitoring wells. Results indicated that the exfiltration trenches did not adversely affect the groundwater. Lead and zinc apparently were trapped or removed by the exfiltration trenches. The swales showed signs of anaerobic conditions, most likely resulting from poor drainage conditions and high organic content soils. At the swale sites, groundwater measurements of ammonia nitrogen, iron, and dissolved solids were significantly greater, and groundwater measurements of sulfate were significantly less than those in the groundwater near the exfiltration trenches. The evidence of significant biochemical cycling associated with

anaerobic conditions in the groundwater near the swales eliminated the possibility of evaluating the swales' influence on groundwater quality.

Yousef et al. (1986) discussed the potential for groundwater contamination near a highway runoff retention/detention pond. Heavy metal concentrations in the groundwater were compared to those in the pond. In general, mean concentrations of all heavy metals except copper were greater in groundwater beneath the pond than in the water within the pond. Reductions in the pH of the pond water, as a result of sediment accumulation, were believed to increase the release of metal ions into the groundwater. Yousef et al. (1986) recommend that pond sediments be removed every 10 to 20 years to reduce the leaching of metals.

Water quality in a well near the pond was compared to water quality in a well near a swale receiving highway runoff and also to water quality in a third control well. Iron, lead, and chromium concentrations beneath the swale were twice the concentration values beneath the pond and 3 to 10 times higher than concentrations in the control well (Yousef et al, 1986).

Zinc levels in groundwater can also be affected by highways. Schiffer (1988) monitored water quality in a surficial aquifer near a highway runoff detention pond and cypress wetland during dry (April) and wet (October) seasons. Samples from the wells closest to the highway exhibited higher concentrations of dissolved zinc than concentrations from other wells and in the wetland. Zinc concentrations in wells near the highway were as high as 220 µg/L, whereas concentrations in the wells further from the highway were almost always below 50 µg/L and never above 100 µg/L. Samples were also tested for lead; and all concentrations were below the detection limit.

Highway runoff may contain constituents other than metals. Schiffer (1988) found that dissolved Kjeldahl nitrogen concentrations from wells closest to the highway were twice as high as concentrations in other wells and in a wetland receiving highway runoff. Organic compounds also may pose potential problems for groundwater quality (Schiffer, 1989). This particular study focused on inorganic constituents, and analyses of organic compounds were limited and qualitative.

Ku and Simmons (1986) measured concentrations of pollutants in groundwater below a recharge basin receiving stormwater runoff from a major highway. They found that in terms of the chemical and microbiological constituents of stormwater, there were no significant adverse effects on groundwater quality. Their data are presented in Table 4.4.

Table 4.4
Median Values of Characteristics of Stormwater, Groundwater, and Precipitation,
Recharge Basin, Plainview, New York
(Ku and Simmons, 1986)

Parameter	Surface Water	Groundwater	Precipitation
Turbidity (NTU)	20.0	0.4	0.5
Spec. Cond. (mmhos)	120	200	NA
Total Coliform (MPN)	24000	3	NA
Fecal Coliform (MPN)	640	3	NA
Fecal Strep. (MPN)	24000	3	NA
BOD, mg/L	10.0	2.5	NA
pH	6.9	6.6	7.1
Cadmium, diss., µg/L	1.0	1.0	0
Cadmium, susp., µg/L	0	0	0
Cadmium, tot., µg/L	1.0	1.0	1.0
Chromium, diss., µg/L	2.0	0.5	1.0
Chromium, susp., µg/L	15.0	7.0	6.0
Chromium, tot., µg/L	16.0	7.0	8.5
Lead, diss., µg/L	35.0	3.5	11.0
Lead, susp., µg/L	250	1.0	9.0
Lead, tot., µg/L	275	4.0	16.0
Potassium, diss., mg/L	2.3	1.6	0.2
Chloride, diss., mg/L	10.0	46.0	2.6
Sulfate, diss., mg/L	11.0	16.0	1.6
Fluoride, diss., mg/L	0.1	0.1	0.1
Arsenic, diss., µg/L	1.0	0	0
Arsenic, susp., µg/L	1.0	0.5	0
Arsenic, tot., µg/L	1.5	1.0	1.0
Phosphorous, diss., mg/L	0.05	0.01	0.02
Org. Carbon, diss., mg/L	6.9	2.4	1.8
Org. Carbon, susp., mg/L	7.3	0.9	1.6
Cyanide, tot., mg/L	ND	ND	NA
Calcium, diss., mg/L	7.85	9.0	0.4
Magnesium, diss., mg/L	1.2	3.6	0.2
Sodium, diss., mg/L	8.5	27.0	0.5
Nitrogen, NH3 + Org., mg/L	2.3	0.15	0.32
Nitrogen, NO2 +NO3, mg/L	0.49	0.82	0.28

Schiffer (1989) measured the impacts of an infiltration basin, a detention pond/wetland system, two swales, and an exfiltration pipe on the surficial aquifer groundwater. The depth to the water table varied between sites, from 0.8 feet to 10 feet below the soil surface. Soils at all the locations were similar. Statistical differences between groundwater constituent background concentrations and groundwater constituent concentrations below each structure were assessed.

All of the methods were effective in removing metals and ions but were less effective for nutrient removal. Nitrite plus nitrate and phosphorus concentrations were highest in groundwater near the swales and the exfiltration pipe, and Kjeldahl nitrogen was highest near the ponds. Turbidity and color were significantly higher in the groundwater near the ponds. Specific conductivity and pH were lowest beneath the swales. The pH was frequently below pH-6.5, a violation of drinking water standards, at both of the swales and at one of the ponds.

Lead, chromium, and copper were below detection levels (1 mg/L) near all of the structures. High iron concentrations near the swales (median value of 815 ppb) and near the detention pond (median value of 1700 ppb) were attributed to the surrounding soil type rather than to highway runoff. Potassium and sulfate concentrations were highest near the exfiltration pipe, but were still below drinking water standards. The nitrate standard (10 mg/L) was only exceeded in one sample near the exfiltration pipe. Schiffer (1989) reports that the organic compounds retained in pond sediments may present potential problems for groundwater quality.

The effects of highway runoff on groundwater are spatially dependent on local hydrological conditions, as well as on sorption processes within the aquifer. Transport of contaminants also is influenced by groundwater velocity. Yousef et al. (1986) found limited effects at one site in Florida due to a groundwater velocity of only 10 meters per year. Furthermore, pollutants may be immobilized on the ground surface and in the vadose zone. Bell and Wanielista (1979) observed low concentrations of metals in groundwater near a highway, including lead concentrations at levels which did not exceed Florida water quality standards (<0.05 mg/kg). Their data indicate that heavy metals are retained by the soil, generally are immobilized, and hence do not leach downward.

The attenuation of stormwater contaminants from highway runoff within unsaturated limestone was studied by Waller et al. (1984). They found that even thin soils could provide significant reductions in contaminants. Lead concentrations of 610 $\mu\text{g/g}$ and zinc concentrations of 91 $\mu\text{g/g}$ were found in the thin (about 1 inch) surface soils, nearly 20 times more than the concentrations of these metals at greater depth. Soil and rock samples at a control site remote from heavy traffic contained low concentrations of metals and showed little variation with depth.

Little and Wiffen (1978) also investigated lead retention in roadside soil and vegetation along a heavily traveled motorway near London. They estimated that 22% of the total lead emitted in vehicular exhaust since the highway opened (10 years ago) was present in the soil and vegetation within 100 m of the road. They also found that the maximum influence was most marked at distances of less than 5 m from the road and becomes undetectable beyond 30 m, results similar to those obtained by Milberg et al. (1980) and Warren and Birch (1987). Other studies documenting the distribution of metals in roadside soils include Lagerwerff and Specht (1970) and Ward (1990).

These results indicate that where sufficient soil thickness is present, natural processes occurring in soils can attenuate pollutants in highway runoff prior to reaching the groundwater. On the other hand, Milligan and Betson (1985) studied an area with thin soils in a karst terrain and suggested that urban stormwater runoff may have a significant impact on groundwater quality.

Because of the near-surface immobilization of pollutants, highways may be a greater threat to soil-water than groundwater. Howie and Waller (1986) analyzed lithological material under highway swales and found high concentrations of lead (1000-6600 $\mu\text{g/kg}$), iron (490-2400 $\mu\text{g/kg}$), and zinc (90-1800 $\mu\text{g/kg}$) in the top 6 inches (15 cm) of soil. Concentrations of this magnitude were not detected in lithological samples collected at an unaffected control site. Even with the concentrations of metals reported in the soil, no obvious impact of highway runoff on groundwater was found.

Bell and Wanielista (1979) sampled groundwater in the vicinity of several highways in east-central Florida in a study of overland flow and the deposition of highway-related heavy metals. The metals considered were lead, zinc, copper, chromium,

nickel, and cadmium. Topsoils contained higher concentrations of metals than subsurface soils. This phenomenon was especially true for lead, which was less mobile in soil than other metals.

Kobriger and Geinopolos (1984b) studied the sources and migration of highway runoff pollutants at four sites across the United States and found that metals are not the only pollutants immobilized during infiltration. Percolation to groundwater was one of the migration paths considered, and zero-tension lysimeters were used to measure the quantity and quality of water in the unsaturated zone. The data from this study are presented in Tables 4.5 and 4.6 for all sites. These data indicate an inverse relationship between distance from the highway pavement and sodium and chloride concentrations. Metals concentrations were also higher in near-highway samples, but to a lesser degree. Metals and sodium concentrations generally were higher in topsoil layers than in substrate layers, but the filtration process varied in effectiveness with different soil types.

Table 4.5
Lysimeter Water Quality Data (mg/L) - Milwaukee I-94 site
(Kobriger and Geinopolos, 1984)

Parameter	Distance from the edge of the pavement					
	2 meters		12 meters		24.5 meters	
	Range	Mean median, m	Range	Mean median, m	Range	Mean median, m
pH	7.5-8.0	7.8	6.85-8.1	7.5	7.2-8.1	7.7
TS	733-3570	2150	218-440	326	308-418	379
TVS	--	NA	--	61	--	NA
SS	--	NA	10-98	33	3-11	7
Pb	0.2-3.5	1.5	ND-4.1	0.2	ND-0.1	ND
Zn	0.19-2.0	0.88	0.06-5.7	0.80	0.03-0.11	0.08
Fe	3.6-102	41.2	0.05-4.3	2.0	0.3-1.6	0.76
Cr	0.03-0.20	0.10	ND-0.06	0.03	0.01-0.02	0.02
Cu	0.49-2.2	1.15	0.06-0.43	0.16	0.01-0.04	0.03
Cd	ND-0.04	0.02	ND-0.08	ND	ND-0.02	ND
Ni	ND-0.2	ND	ND-0.20	ND	ND-0.1	ND
As	--	NA	--	ND	--	NA
Hg	--	NA	--	ND	--	NA
NO ₂ +NO ₃	--	NA	0.04-0.34	0.21	ND-0.04	0.02
TKN	--	NA	1.8-3.2	2.6	ND-2	1
PO ₄	--	NA	0.21-1.93	0.60	ND-0.04	0.03
Sulfate	ND-110	ND		NA	18-26	24
Na	80-860	470	12-80	38	5-37	20
Cl	100-825	362	ND-272	20	42-125	87
Ca	14-98	56	2.8-38	14.5	21-78	59

ND = Not detectable.

NA = No analysis performed due to limited sample quantity.

Table 4.6
Lysimeter Water Quality Data (mg/L) - Harrisburg I-81 site
(Kobriger and Geinopolos, 1984)

Parameter	Distance from the edge of the pavement							
	1.2 - 1.8 meters		2.1 meters		3.2 - 3.9 meters		13.7 meters	
	Range	Mean median, m	Range	Mean median, m	Range	Mean median, m	Range	Mean median, m
pH	5.6-8.4	6.6	6.95-9.1	7.0	5.90-8.0	7.5	5.6-7.8	6.3
TS	66-3550	587	918-1370	1140	101-3090	751	28-422	158
SS	6-1550	201	112-1040	574	40-2430	381	8-50	25
Pb	ND-0.6	0.1	ND-0.2	ND	ND-0.6	0.04	ND-0.50	ND
Zn	0.04-1.5	0.24	0.12-0.76	0.44	0.07-0.83	0.30	0.06-2.0	0.27
Fe	0.3-130	11.2	9.5-40.3	24.9	1.3-95.8	16.6	0.4-14	2.1
Cr	ND-0.07	0.01	--	0.08	ND-0.14	0.005	ND-0.07	ND
Cu	0.02-0.26	0.09	--	0.16	0.037-0.21	0.09	0.029-0.20	0.09
Cd	ND-0.05	ND	--	0.02	ND-0.02	0.004	ND-0.08	0.01
Ni	ND-0.3	ND	--	ND	ND-0.3	0.02	ND-0.2	ND
C1	6-2060	114	40-110	75	5-130	45	ND-41	10
NO ₂ +NO ₃	0.46-27.5	7.0	--	NA	5.8-23.0	15.0	0.03-1.36	0.17
TKN	0.78-5.6	3.0	--	NA	2.62-3.60	3.01	ND-2.85	2.3
PO ₄	0.77-3.20	1.59	--	NA	0.53-0.86	0.70	0.02-5	1.2
Na	3-1300	81	25.6-125	75.3	13.8-88	29.6	1.2-8.2	3.9
Ca	10-74	30	--	NA	--	NA	2-11	7
Hg	0.0005-0.0014	0.0010	--	NA	--	NA	--	0.0005
SO ₄	ND-133	30	--	61	10-104	48	ND-22	7
O&G	2-3	3	--	NA	--	NA	--	NA

ND = Not detectable.

NA = No analysis performed due to limited sample quantity.

5.0 HIGHWAY CONSTRUCTION

5.1 Environmental Effects of Highway Construction

Highway construction and associated grading activities typically are initiated with a clearing and grubbing phase in which vegetation and other naturally occurring soil-stabilizing materials are removed from the construction site. The surface areas and slopes created by excavation or embankments are exposed to the erosive forces of wind, snow melt, and rain until the earthwork is completed and the grassy vegetation is restored or the surface is artificially stabilized.

Soil losses from erosion may be inconsequential when compared to the damage resulting from sediment transport and deposition into surface waterways. Fish spawning areas and benthic habitats may be destroyed or damaged when sediment deposition covers stream and river bottoms. Suspended solids also reduce light transmission, which limits in-stream photosynthesis and diminishes aquatic food supply and habitat. Suspended solids also may coat and abrade aquatic organisms, reduce surface water quality and suitability for various usages, and lead to diminished capacities of reservoirs or other conveyance systems due to deposition (Goldman et al., 1986). The eroded solids may be further disruptive by serving as a transport medium for phosphorus, nitrogen, and toxic compounds. Miller et al. (1982) compare several methods for the prediction of erosion from highway construction sites. Other studies dealing with erosion modeling include Haan et al. (1994), Reed et al. (1985), Israelson et al. (1980), Ward (1985), Meyer et al. (1975), Swerdon and Kountz (1973), Fan and Lovell (1988), Younkin and Connelly (1981), Younkin (1973), and Anderson and Simons (1984).

Even though highway construction may only cover a small portion of a watershed, the effects can be substantial. Vice et al. (1969) studied the movement of sediment during a period of intensive highway construction in a 4.5 square mile drainage basin in Virginia. They allocated sediment to source areas and showed that highway construction areas, varying from less than 1 to more than 10 percent of the basin at any one time contributed 85 percent of the sediment load.

Many studies have documented the effects of highway construction on the quality of surface waters. In general, changes in water quality are the result of an increase in the suspended sediment discharged from construction sites. The higher suspended solids levels result in reduced diversity and density of fauna in the affected area. These changes are usually temporary and conditions eventually return to pre-construction levels.

Reed (1977) investigated how aquatic macrobenthic and fish communities responded to the effects of siltation from highway construction. He evaluated community response on the basis of community diversity and changes in the numbers of organisms and/or species. The primary response observed among the macrobenthic and fish communities was a reduction both in numbers of species and in organisms downstream from the construction. The diversity index also demonstrated a statistically significant long-term change in aquatic community structure but was less meaningful for indicating initial effects or making single comparisons. Reed suggests that drift is a major physical response of macrobenthos to increased siltation and may be a primary mechanism for repopulating stressed habitats. This is contrary to the commonly held hypothesis that smothering is a major effect and should be tested in further investigations. Fishes apparently vacated areas of increased siltation but were able to repopulate such areas within 12 months after construction activity ceased. In general, Reed found that erosion-control measures as they commonly are applied in highway construction were of limited value in preventing damages to stream communities, especially in the early construction stages.

Three highway construction projects in California were studied by Howell et al. (1979) to determine the influence on the water-quality environment. They found that most impacts were not foreseen in the preconstruction environmental assessment. Almost all of the short-term effects involved erosion and subsequent sediment transport into a stream. They found that mitigation measures were effective at reducing these effects. Howell et al. recommended that only projects with a direct bearing on a stream, lake, wetland, or other aquatic feature need have a comprehensive water quality study performed.

Horner and Welch (1982) investigated the effects of channel reconstruction of the Pilchuck River on benthic macroinvertebrates and fish. They found that a substrate comparable to the original was recovered within 1 year. The fauna was subject to temporal variation unrelated to the construction, but results showed no indications of deterioration in diversity, quantity, or size in the reconstructed channel.

A limnological investigation was carried out by Barton (1977) to document the effects of highway construction on a small stream in southern Ontario. During construction, suspended solids increased to as high as 1390 mg/L, but later returned to pre-construction levels of <5 mg/L. Similarly, sediment deposition increased 10-fold below the construction site during stream rechannelization. There was no change in water chemistry; however, the standing crop of fish was reduced from 24 to 10 kg/ha immediately below the site. The decrease did not occur further downstream and the populations at the affected site returned to original levels after construction.

Embler and Fletcher (1983) sampled streams for turbidity and suspended solids upstream and downstream of a construction site in Columbia, South Carolina. Stream measurements were taken before, during, and after construction. Rainfall was sampled as well. Peaks of turbidity and suspended solids concentrations were much greater after construction began. Turbidity never exceeded 25 NTUs during the preconstruction period, but after construction began, turbidity peaks ranged from 50 to 80 NTUs. Suspended solids concentration remained below 30 mg/L prior to construction. The peak suspended solids concentration varied between 60 and 130 mg/L after construction began.

A 5-year study of the effects of highway construction in the 38 square mile Blockhouse Creek basin was conducted by Hainly (1980). He collected water discharge, suspended-sediment discharge, and stream-temperature data at four stations in the basin. The study period included 1 year before construction, 2 years during construction, and 2 years after construction. The effects of stream relocation and sediment-control methods used in the highway construction were also investigated. During the period of data collection, about 35,500 tons of suspended sediment were transported by Blockhouse Creek and Steam Valley Run. The data indicated that 9,100 tons was introduced to the stream from construction areas. The normal sediment yield for the two basins was

determined to be 80 tons per square mile per year. Most of the sediment was transported by the streams during high flows and probably passed through Blockhouse Creek, as little deposition was observed below the construction area. Stream temperature seemed to be relatively unaffected by the stream relocations and diversions.

Helm (1978) studied the effects of highway construction on suspended-sediment loads in the upper reaches of the Schuylkill River basin, Schuylkill County, Pennsylvania, from April 1975 to March 1977. From March 1975 to October 1976, 4.3 miles of State Route 209 was relocated through the upper reaches of the basin, a mountainous watershed with a drainage area of 27.1 square miles. About 16,000 tons of suspended sediment was discharged from the basin during the construction. The highway construction produced about 8,000 tons or 50 percent of the total sediment discharged. Steep slopes, the availability of fine coal wastes, coal-washing operations, and other land uses in the basin were responsible for most of the remaining sediment discharge.

Downs and Appel (1986) documented the impacts of construction of the four-lane Appalachian Corridor G highway in South West Virginia. The highway disturbed about 2 square miles in the Coal River and 0.35 square miles of the 4.75 square mile Trace Fork basin. Construction had a negligible effect on runoff and suspended-sediment load in the Coal River and its major tributaries, the Little Coal and Big Coal Rivers. Drainage areas of the mainstem sites in the Coal River basin ranged from 269 to 862 square miles, and average annual suspended-sediment yields ranged from 535 to 614 tons/square mile for the 1975-81 water years. Suspended-sediment load in the smaller Trace Fork basin (4.72 square miles) was significantly affected by highway construction. Based on data from undisturbed areas upstream from construction, the normal background load at Trace Fork downstream from construction during the period July 1980 to September 1981 was estimated to be 830 tons; the measured load was 2,385 tons. Runoff from the 0.35 square mile area disturbed by highway construction transported approximately 1,550 tons of sediment. Downs and Appel (1986) also found that suspended-sediment loads from the construction zone were higher than normal background loads during storms as well.

Chisholm and Downs (1978) recorded the effects of construction of the Appalachian Corridor G highway on the benthic population of a stream receiving

construction runoff. They found severe depletion or destruction of the benthic community. However, within one year, rapid repopulation and stabilization of the community occurred. They report that channel relocation, bank recontouring, and reseeded accelerated the recovery of the community.

Eckhardt (1976) studied the effects of highway construction on stream sediment loads in Applemans Run basin, Columbia County, Pennsylvania, from October 1971 to May 1974. During the investigations period of, about 5,200 tons of suspended-sediment was discharged from the basin. Of this amount, about 2,700 tons, or about half the total sediment discharge, was derived from the highway construction area. Annual suspended-sediment yields from 17.5 acres under construction ranged from 40,000 to 66,000 tons/square mile in the 1972 and 1973 water years, respectively. In the 1972 and 1973 years of active construction, 83 percent of the sediment transported from the construction site was eroded each year in storms from January to June. Seasonal trends in sediment discharge for 1972 show that 69 percent of that year 's suspended load was transported in April, May, and June, whereas less than 1 percent was transported in July, August, and September. Eckhardt (1976) reported that high sediment yields from the construction area continued after the completion of the highway in August 1973, even though seeding and mulching had reduced the erodibility of the steep embankment slopes. Those operations did not fully take effect until the spring of 1974, when a protective cover of crown vetch matured and measured sediment yields from the basin returned to normal.

Reed (1980) collected rainfall, streamflow, sediment, and turbidity data at an area of highway construction near Harrisburg, Pennsylvania. He found that construction increased suspended-sediment discharges from two- to four-fold; however, the rate of sediment discharge quickly returned to preconstruction levels.

The influence of highway construction on a high mountain stream was investigated by Cline et al. (1982). They found that the proportion of fine sediment in the substrate increased at impacted sites, but rapidly returned to levels similar to reference sites following cessation of construction. At the impacted sites, algal species diversity and the organic content of the epilithon were reduced. The macroinvertebrate community was altered by construction activities at some locations but not others and was generally

less severely affected than the researchers anticipated. Where alteration occurred, reduction in density, abundance, and diversity were apparent. The potentially adverse impacts were apparently ameliorated by the hydrologic regime and high gradient of the study stream.

Ebert and Filipek (1988) documented the response of fish communities to habitat alteration caused by reconstruction and upgrading of a portion of a state highway in Arkansas. As a result of the construction, portions of Haw Creek, a third-order stream in the Boston Mountains, were straightened and channelized. In reconstructing stream reaches, stream banks were riprapped and vegetated, gabions constructed and positioned, and stream substrates and pool/riffle ratios altered. The authors report that the channelized reaches became wide and shallow, lacking overstory cover and pools. Substrate particle size changed from boulder/rubble to rubble/gravel/sand and velocity increased. *Campostoma anomalum*, *Notropis boops*, and *Etheostoma spectabile* accounted for more than 80 percent of all fish captures. This represented a shift from piscivore and insectivore/piscivore to herbivore and insectivore dominated feeding guilds. Natural channel reaches had more complex fish communities and greater abundance of sunfish and catfish (primarily deeper water groups). Immediately after channelization, altered reaches had a larger biomass than natural reaches (0.43-0.26 g/sq m). The summer following alteration, channeled segments were nearly dry and biomass decreased dramatically (0.06-0.11 g/sq m). One year after channelization, altered reaches had eroded, scoured and deepened at their headwaters, and embedded. Fish community composition in altered reaches stabilized to a riffle-type assemblage dominated by the herbivore *Campostoma anomalum*.

The influence of highway construction on the Weber River in northern Utah was evaluated by Barton et al. (1972). Data on invertebrates, fishes, and hydrology were gathered to compare areas changed by highway construction with those unchanged by construction work. Eight study reaches were established, four in areas that were not to be changed and four in changed areas. Barton et al. report that structures built into changed channels of the Weber River were effective in producing fish habitat that was comparable to, if not better than, the habitat of the unchanged sections. Structures made of large

riprap material were found to be economical and produced good fish habitat. Invertebrates colonized the new river bottom and produced equivalent numbers and species after 6 months. Fish populations were essentially equal in changed and unchanged areas 2 years after the construction.

Yew and Makowski (1989) discussed an area along the Tennessee-North Carolina border where highway construction contributed to toxic conditions for fish in several area streams. Highway excavation exposed a pyritic shale material, which allowed leaching of sulfides in the form of sulfuric acid. Analysis of water quality data indicated that a combination of low pH (4.0 to 4.4) and alkalinity along with increased toxic metal concentrations contributed to the toxic conditions at these impacted sites. Temporary control measures included the addition of sodium hydroxide to the acidic streams. More permanent mitigation involved sealing the exposed pyritic material in the road embankments from surface water infiltration with lime and topsoil.

A 20-month study of the effects of the construction of Interstate 10 near Tallahassee, Florida, was conducted by Burton et al. (1976). They found that construction resulted in significant increases in turbidity, suspended solids, total phosphorus, and dissolved silicon, despite the extensive use of erosion controls. No increased loadings were found for dissolved phosphorus or nitrogen.

Extence (1978) also documented adverse effects of road construction runoff on the chemistry, biology, and physical appearance of a receiving stream. They identified increased solids discharge as the source of the problems. Deposition of sand and silt in the channel reduced the density and diversity of invertebrates in the affected area as compared to an upstream monitoring site.

Streams near Richmondville, New York, were monitored 2 years prior to construction, during construction, and 2 years after completion of the construction (Besha et al., 1983). Little evidence of construction-related declines in water quality was observed. Rather, peak concentrations were the consequence of high rainfall rather than construction activity. Turbidity reached high levels in one of the creeks, but only infrequently and temporarily. Other variables experienced no detectable change due to construction activity.

Duck (1985) investigated the effects of erosion during construction of a road near Loch Earn in the Scottish Highlands. He found that in a 2-month period, 20 times as much sediment passed a temporary gauging station than had during an earlier 12-month monitoring period. The mean thickness of the resultant deposit measured in the lake should, under normal circumstances, have taken 20 to 25 years to accumulate.

The general destruction of wetlands is quantified by Hall and Naik (1989), and highway construction is listed as one of the principal activities contributing to this destruction. Highway construction has resulted in the loss of mangroves, seagrass, marshes, and swamps. The authors describe a number of highway construction sites and report on the effectiveness of the mitigation actions taken at each one.

Cramer and Hopkins (1982) focused on a Louisiana wetland in a study of construction impacts. Turbidity, color, salinity, DO, and pH were monitored before, during, and after construction for bridged highway construction techniques. The changes in salinity, DO, pH, and solids which occurred were attributed to factors other than construction. For example, changes in salinity at two sites could be traced to pollution from an automobile battery plant. However, the wetland did show an increase in turbidity and color resulting from construction activity. Turbidity began to decrease and color began to return to ambient conditions after conclusion of highway construction.

Crabtree et al. (1992) reviewed wetland mitigation efforts at 17 highway construction sites across the country. The mitigation efforts included restoration, creation, and enhancement of wetlands. They found that ineffective mitigation could usually be attributed to lack of attention to detail in the planning, design, and implementation processes. Effectiveness was improved through baseline monitoring, proper mitigation site selection, detailed mitigation plans, monitored construction activities, and post-construction remediation and monitoring.

Ecological effects of highway construction on Michigan woodlots and wetlands were investigated by McLeese and Whiteside (1977). They found that the most significant effects of construction on the soil environment were the erosion of soil materials and the alteration of natural soil drainage conditions. Natural soil drainage conditions and circulation patterns are easily disrupted at sensitive wetland sites. They

suggest methods for predicting the potential soil loss and potential changes in natural soil drainage conditions due to highway construction.

Garton (1977) reported on an incident where highway construction had a very serious impact on groundwater quality. Construction of part of Interstate Highway 79 in West Virginia uncovered pits and caverns overlying a karst aquifer which was the source of springs used as a water supply for the Bowden National Fish Hatchery. Large quantities of clay and silt were washed into the caverns, resulting in very turbid springflow during storms. During one event, more than 150,000 trout died due to silt build-up on their gills. Other fish kills were the result of poisoning by diesel fuel, which was spilled on the construction site and washed into the caverns. In addition, damage to the hydrogeologic environment occurred because the construction beheaded the aquifer, resulting in reduced flow and rechannelization of water away from the spring.

Geiser (1974) reported on the effects of turnpike construction on groundwater quality in an area of Germany. Highway construction operations, including those involving vibrations, caused a temporary impairment of the groundwater that had originally been of high quality, resulting in a general rise in both the germ count and in the appearance of coliform bacteria. The water quality returned to normal after completion of the turnpike construction.

Finally, it should be noted that many factors may make it impossible to isolate the effects of highway construction (German, 1983). These include land-use changes, socioeconomic changes, and natural changes in a receiving water's plant community. The relative effects of surrounding land use were documented by Helsel (1984). He found that a highway construction area near Columbus, Ohio, contributed between 9,580 and 15,700 tons of sediment per square mile per year. Surrounding suburban terrain yielded 428 to 754 tons per square mile per year. However, the size of the construction project was small in comparison to the surrounding suburbs, so that no more than 4% of the yearly downstream sediment load was produced by the highway construction.

5.2 Performance of Erosion and Sediment Controls

Early Roman and Greek engineers identified a connection between deforestation and increased harbor sediment deposition (Crebbin, 1988); however, the environmental regulation of construction projects is a recent development. Prior to the 1960's, construction activities were executed along the path of least resistance to minimize costs and reduce planning and construction duration (Gervais and Piercey, 1988). Increased awareness and concern eventually led to the passage of the National Environmental Policy Act of 1969. This legislation initiated various strategies for the control of erosion and sedimentation and permitting requirements (Teamah, 1993). The Act also required that federal agencies utilize a systematic interdisciplinary approach that would insure the integrated use of the natural and social sciences and the environmental design arts in planning and decision-making that could have an impact on man's environment (Gordon, 1975). By 1971, the technical capability for controlling erosion of soils existed; however, there was still a problem in achieving effective administrative control and enforcement by concerned agencies (Thronson, 1971).

The Federal Clean Water Act of 1977 subsequently provided for the regulation of construction runoff into surface water bodies (Crebbin, 1988). The Clean Water Act requires a National Pollutant Discharge Elimination System (NPDES) permit to discharge construction site effluent (Texas Department of Transportation, 1992). The provisions of NPDES mandate that a project-specific Storm Water Pollution Prevention Plan (SW3P) be developed and implemented for each project with a disturbed area greater than five acres.

The Highway Research Board (1973) reported that construction activities which are subject to high erosion risks include right-of-way clearing, earthwork, ditch construction, haul roads, culvert installation, channel changes, pier or abutment work in streams, temporary stream crossings, borrow pit operation, and hydraulic or mechanical dredging. Factors in addition to exposed area that affect erosion and sediment production are rainfall intensity, slope, soil type, rate of runoff, and depth and velocity of runoff. The Research Board (1973) also states that erosion potential must be assessed during the route study and location phases. Soil types, anticipated cuts and embankments, grades,

proximity to critical areas, and channel change requirements should be studied and costs estimated if special protection is necessary.

Sullivan and Foote (1984) surveyed roadside erosion along all state, county, and township roads in Minnesota and reported that roadway design is an important factor in determining the amount of soil loss. They found that the design which resulted in the greatest soil loss was the cut-fill design, whereas the fill design had the lowest soil-loss volume. Erosion can also be minimized by administrative direction and emphasis, especially in the establishment of vegetative cover, and by maintenance repair of erosion sites.

Mitchell (1993) analyzed the results of surveys of state departments of transportation and, in conjunction with a field assessment, provided recommendations for effective erosion and sediment control. He emphasized the importance of presenting and discussing erosion and sediment control plans with the contractor at the preconstruction conference. He suggested that a prewinterizing meeting be held with the contractor to discuss plans for maintenance of control items during the winter season. More specific guidelines for maintenance procedures that are needed on control items, such as sediment basins, ditch checks, and filter fabric fence, should be provided. Mitchell also emphasized the importance of implementing erosion control measures in a timely fashion and developing and implementing a training program for project engineers and others involved in providing erosion/sediment control during highway construction.

The two most basic categories of temporary control methods for construction-generated pollution are erosion control and sediment control. Slope coverings represent the primary component of erosion control or source management methods. Slope-covering techniques include temporary and permanent vegetation establishment, plastic sheeting, straw and wood fiber mulches, matting, netting, chemical stabilizers, or some combination of the above (Horner et al., 1990a,b). Sediment control may be considered as the second line of defense and includes, sedimentation ponds, post-sedimentation pond devices, and silt or sediment barriers (Hittman Associates, Inc., 1976).

Haan et al. (1994) point out that the effectiveness of sediment control techniques must be made on a systems basis rather than by evaluating individual components. They

cite the example of a sediment pond controlling runoff from a bare soil. Such a pond might be expected to trap 90% of the sediment. After revegetation, however, the vegetation will tend to prevent erosion of the larger particles, resulting in a finer particle size distribution. The trapping efficiency of the pond may drop drastically as a result. However, the incoming sediment load would be reduced by the vegetation and therefore the pond sediment effluent would also be reduced. Haan et al. (1994) conclude that the pond effectiveness cannot be evaluated in isolation from a hydrologic and sedimentation analysis of the entire watershed.

In general, a variety of control devices is required for each construction project. Versteeg and Earley (1982) described several features used during the reconstruction of a section of Interstate 5 in Oregon. To control stream turbidity, heavy equipment was kept out of the stream channel as much as possible and stream-crossing-sediment traps were constructed. Dikes were built to isolate construction activities from the flowing stream. Straw bales underlain with drain rock were placed in slope gullies. Seed and straw mulch were put on slopes. Slopes were terraced to reduce soil erosion. Shrubs and willow trees were planted to control erosion and maintain cooler water temperatures.

The effects of erosion control structures on sediment and nutrient transport at three sites along Nevada State Highway 207 in the Lake Tahoe Basin were investigated by Garcia (1988). Site 1 was thought to have been largely unaffected by urban development and was completely unaffected by erosion control structures. The flow at Site 2 was from a basin affected by urban development and erosion control structures. Site 3 was downstream from the confluence of streams measured at Sites 1 and 2. Garcia found that as a result of the erosion control structures, mean annual concentrations of total sediment were reduced from about 24,000 to about 410 mg/L at Site 2 and from about 1,900 to about 190 mg/L at Site 3. At Site 1, mean concentrations and loads remained low throughout the study period. At Site 2, sediment particle size changed from predominately coarse prior to construction to predominately fine thereafter; at Site 3, it changed from about half coarse to predominately fine. Mean concentration and loads of total iron also were significantly reduced after construction at Sites 2 and 3, whereas mean concentrations of nitrogen and phosphorus species did not change appreciably.

Kroll (1976) studied the sediment discharge from cut-slopes of completed highways in the Lake Tahoe Basin. He found only minimal contribution from cut-slopes to the total load of sediment to the lake. The estimated long-term annual sediment discharge from six streams into the lake was 7,100 tons, of which the highway slopes were the source of less than 100 tons. The data collected were not adequate to demonstrate the effectiveness of treatments to stabilize the cut-slopes.

The Pennsylvania Department of Transportation and Environmental Resources and the U.S. Geological Survey cooperated in a field study to determine the effectiveness of various erosion-control measures during highway construction on I-81 (Weber and Reed, 1976). Hydrologic parameters including water and sediment flow were monitored in five adjacent watersheds near Harrisburg, Pennsylvania. Different types of erosion control measures were used in each watershed to prevent soil exposed by the construction activity from entering the stream system. The area under active construction correlated well with the sediment load transported by the streams. The onsite holding devices, such as off-stream ponds, appeared to be the most effective method of sediment control on this project. Seeding and mulching had a minor effect on sediment production until vegetative growth was well established. The placing of the subbase had a major effect on sediment production due to the large exposed area involved.

Hainly (1980), in a study of highway construction impacts on two streams in Pennsylvania, reported that physical sediment-control methods were able to limit sediment discharge during baseflow periods and small storms. Coarse sediments especially were controlled by these methods. He found that the most effective method of sediment control was limiting the amount of time that the construction-area soils were exposed to erosion.

Schueler and Lugbill (1990) found that erosion control measures, especially vegetative stabilization, were the most important line of defense, providing at least a six-fold reduction in downstream suspended-sediment levels.

Various mulches, blankets, chemical products, and silt fencing were tested for erosion control from highway construction sites in the state of Washington by Horner et al. (1990a). They reported on the effectiveness of these devices for erosion prevention

and pollutant removal. Pollutant constituents measured included solids, metals, phosphorus, and organic content. Their results indicate that several methods were effective in removal of pollutants. A wood fiber mulch accompanied by grass seeding was the most cost-effective slope covering. Fabric fences, straw mulches, and a woven straw blanket were considerably more expensive than wood fiber mulch.

The erosion-inhibiting potential of nine commercial plastic chemicals was evaluated by Wyant et al. (1972). They found that differences in soil affected the relative performance of the chemicals, so that no one chemical performed best at all sites. In addition, none were more effective than straw tacked with an asphalt emulsion.

Spooner and Murdoch (1970) report that a fiber mulch is essential for establishment of vegetation. Prevention of erosion and maintenance of necessary soil moisture are the principal factors. They found that tall fescue, common bermudagrass, weeping lovegrass, and bagiagrass were the most adaptable species for highway use in Arkansas.

Armstrong and Wall (1991) and Wall (1991) used simulated rainfall on highway slopes to evaluate hydraulic mulches and erosion control blankets. They ranked the effectiveness of several of these products. Armstrong (1991, 1992) also developed a protocol for testing new surficial erosion control products.

Carroll et al. (1991) used an indoor concrete flume to test synthetic mats and blankets for erosion protection and establish performance limits and design guidelines. They found that turf reinforcement mats with soil filling were found to adequately controlled erosion of bare soil at flow velocities of 11 ft/s for 0.5 hour durations, while revegetation mats controlled erosion of bare soil at velocities up to 18 ft/s for 0.5 hour durations.

Wright et al. (1976) recommend that erosion be minimized based on the principles of maximizing water infiltration and reducing water runoff through the use of rough and stair-step grading to establish vegetative cover quickly. Rough grading should be augmented temporarily by mulches until fast-growing, temporary canopies develop. They report that soil amendments applied to a properly prepared seedbed eliminate the need for topsoil, which is often of poor quality.

Sediment barriers or check dams are nonengineered structures designed to diminish solids loading through short-term retention and/or velocity reduction and filtration. Four basic types of sediment barriers are straw bale barriers, silt fences, gravel or earth berms, and filter fabric upon straw bales or brush (Goldman et al., 1986). Other methods suggested by TxDOT (1992) include diversion, interceptor and perimeter dikes, interceptor and perimeter swales, stone outlet structures, brush and sandbag berms, triangular sediment dikes, and stabilized construction entrances.

A survey of highway construction sites in Ohio (Mitchell, 1993) found that hay bales were often not installed properly or were inadequate/inappropriate for the control required in a particular section. The bale checks were ineffective during heavy rainfall with high velocity flows carrying eroded material under and through the bales or completely moving the bales from their initial placement. Mitchell also reports that straw/hale bays have relatively short service life unless they are frequently inspected, repaired, or replaced, especially after every rainfall event. TxDOT (1992) recommends the use of hay bales and triangular sediment dikes only as the last alternative.

Silt fences are defined as temporary, vertical structures of wood or steel supports, wire mesh reinforcement, and a suitable permeable filter fabric (Goldman et al., 1986). Silt fences are installed to provide a physical barrier to sediment, reduce velocities of water flow, and reduce sediment transport (King County, 1990). Wide-spread silt fence acceptance, preferential selection, and implementation are attributed to purported advantages such as effective operational duration of greater than 6 months, stronger construction, greater ponding depth, minimum removal efficiencies of 75%, easy assembly, and relatively low cost (Goldman et al., 1986). Koerner (1986) presents equations for calculating required height of silt fences based on hydraulic considerations.

Silt fence applications include locations upstream of points of discharge of runoff, down-slope of disturbed areas where sheet flow runoff is expected, and in minor swales or ditches (Goldman et al., 1986). Silt fences also have been used as disturbed area perimeters in which the maximum drainage area is less than 0.8 hectares (2 acres) (TxDOT, 1992). The recommended upper-range operating conditions for silt fences are a

2:1 maximum slope behind the barrier, a 30 m (100 ft) maximum slope length upstream of barrier, and a 0.03 m³/s (1 cfs) maximum concentrated rate of flow (Kouwen, 1990).

Proper installation techniques and materials are required to reduce the risk of common failures such as undercutting, end runs, holes and tears, over-topping, and fence collapse (Kouwen, 1990). Installation measures include a 15 cm (6 inch) minimum toe in, steel or wood post supports spaced less than 2.4 m (8 ft) and embedded at least 0.3 m (1 ft), and welded wire fabric or woven wire of sufficient gauge to provide adequate reinforcement backing for the fabric and a support to which the fabric may be securely affixed. The fabric selected should not be susceptible to mildew, rot, heat, ultraviolet radiation, or to any other possible deleterious agent (TxDOT, 1992a).

Burlap was the filter fabric of choice prior to the introduction of geotextiles. Burlap, however, was proven to be highly susceptible to environmental decay and of questionable filtration efficiency (Dallaire, 1976). Geotextiles typically are specified as the current filter fabric for silt fence applications (Martin, 1985; TxDOT, 1992).

Geotextiles may be classified according to structure as woven, non-woven, or knitted. Knitted fabrics are not commonly used; therefore, subsequent discussions will be limited to woven and non-woven fabrics. Woven fabrics have uniform rectangular openings created by a weft horizontal element and a warp longitudinal element (World Construction, 1986). Woven fabrics essentially are two dimensional and are often manufactured with a glossy surface texture to diminish particle adherence (Martin, 1985). Non-woven geotextile fabrics typically are manufactured of polymer fibers fused together by heat into a three dimensional orientation (Rollin, 1986). The random fiber arrangement results in a material which is devoid of distinct pores. The filtration mechanism for non-woven fabrics is very complex. The fabric actually may function as a wick in which water flows in the plane of the fabric (Suits, 1986). The role of geotextiles in sediment control was summarized by Theisen (1990).

Kouwen (1990) subjected commonly employed silt barrier materials to sediment-laden flow in a series of laboratory tests. He reported that sediment-trapping efficiency was not dependent on the material used, but this may be due to the fact that he used a medium grain sand in the tests and had close to 100% removal for all fabrics tested.

Testing of fabrics using sediment with a grain size distribution similar to top soil may reveal differences in performance. Kouwen also emphasized proper installation to avoid failure.

The effectiveness of gabions was evaluated by Tan and Thirumurthi (1978) in a study of the effects of highway construction on water supply lakes. They found that the performance of three gabions tested was inadequate and inconsistent. Suspended impurities increased in several cases because surface runoff bypassed the gabions in some cases and the pore sizes of gabion structures were too coarse to effectively filter the water. Addition of hay bales around one of the gabions did not improve water quality.

Sedimentation ponds are designed to intercept and provide runoff storage and promote the sedimentation of eroded particles prior to a filtered or controlled release. Horner et al. (1990a) conducted laboratory studies to determine the best design for sediment removal. They found the best performance was achieved with a length/width ratio of 5:1, two basins used in series, and a perforated riser pipe. Reed (1980) found that offstream ponds were the most effective sediment control, trapping about 70% of the sediment that reached them during most storms. In comparison, seeding and mulching generally reduced sediment loads about 20%, while rock dams and bales reduced loads only about 5%. Sediment removal can be enhanced by post-sedimentation techniques which include vacuum filters, upflow filters, tubular pressure filters or strainers, microscreens, hydrocyclones, and separator screens (Hittman Associates, Inc., 1976).

Schueler and Lugbill (1990) reviewed the performance of current designs of sediment basins and rip-rap outlet traps at several suburban developments in Maryland. They found that despite significant sediment removal, sediment levels in outflows remained elevated with a median TSS of 283 mg/L and a median turbidity of 200 NTUs. The overall performance of these sediment controls was estimated to be only 46% for storm events that produced measurable outflow runoff. The sediment removal capability was greatest for sediment controls in the earlier stages of construction and for storm events that produced less than 0.75 inches of rainfall. They reported that initial sediment settling was quite rapid with as much as 60% removal within 6 hours, but additional removal occurred much more slowly. Also important was adequate sizing of the

sediment basins, so that a minimum of 2 to 6 hours of detention was provided for larger storms.

Nawrocki and Pietrzak (1976) recommended the performance of a preconstruction site survey and analysis of the grain size distribution of the soils. This allows more accurate sizing of ponds for anticipated flow rates. They also recommend that ponds be provided with baffles, that a length to width ratio of 5:1 be maintained, and that inflow and outflow structures be as wide as feasible. They reported that additional fine-grained sediment control can be achieved with the addition of chemical flocculants and with the use of two ponds in series. Also emphasized in their study is the importance of source control. They included tables comparing the effectiveness of different erosion control techniques on slopes of varying steepness.

6.0 CONTROLLING POLLUTION FROM HIGHWAY RUNOFF

The control of pollution from highway runoff can be accomplished by both source management and control measures. Examples of source management are transportation and land use planning and highway design and operation. Structural controls include vegetative practices, ponds, infiltration methods, wetlands, and filters. Certain structures enhance the performance of these structural control methods. Each type of control method will be characterized and its strengths and weaknesses will be identified. Additionally, where information is available, relative costs and expected maintenance activities for each method will be discussed.

In assessing the various methods available for the control of highway runoff, it is important to recognize the differences between urban storm drainage and highway runoff as related to structural control measures. Maintenance activities in urban watersheds can be performed on a more regular basis than can be expected alongside major highways; therefore, some urban runoff control structures commonly described in the literature may not be appropriate for treating highway runoff. These structures may have outlet and/or inlet devices which require manual adjustment based on the prevailing hydrological conditions. These facilities also may involve pre-fabricated, commercially marketed, end-of-pipe treatment technologies. Such devices generally require more frequent monitoring, inspection, and maintenance than would be desirable for highway applications.

Highway runoff pollution mitigation measures require a practical approach. Burch et al. (1985a) stated that pollution associated with highway runoff usually is transported by stormwater runoff along the curbside, pavement, and shoulder areas. Most of the associated pollutant load is either suspended particulate matter or material adsorbed to the suspended solids. Therefore, the most effective control measures either will reduce the amount of particulates available for transport or will settle and/or filter the particulate material in the runoff.

6.1 Source Management

Transportation plans can be designed to reduce water pollution by lowering total vehicle miles traveled. Providing alternate modes of transportation (mass transit) or encouraging carpooling can reduce traffic congestion and fuel consumption. Successful programs reduce the total load of pollutants deposited on highways and rights-of-ways from vehicles (Burch et al., 1985b).

Implementation of land use plans provides indirect mitigation of highway runoff through effects on land use and associated traffic patterns. By controlling development location and density, traffic mix and density can also be controlled and runoff problems minimized. The goal of land use planning for mitigation of highway runoff is to protect the environmental balance of an area in terms of runoff volume, rate, and water quality by restricting developments that generate high traffic volumes in sensitive areas (Burch et al., 1985b). The risk to the quality of public water supply lakes could be reduced by this type of planning (Adams, 1981).

Design and operation of highways affect traffic characteristics and pollutant deposition. Reduction of pollutant runoff can be accomplished by elimination of curbs and other barriers, traffic flow regulation, animal control, minimizing fertilizer and pesticide/herbicide application, and control of debris from mowing (Burch et al., 1985b).

Eliminating barriers from highways prevents many sediments and other particulates from being trapped on the highway. Without curbs, wind and turbulence will remove much of the fine materials from the road. Materials that are not trapped on the roadway are generally immobilized on the roadside (Burch et al., 1985b).

Fencing of highway rights-of-way to minimize animal access to the highway improves safety conditions, reduces accidents, and thereby lessens pollutants from spills, debris, and litter.

The use of fertilizers, particularly in areas with direct runoff to natural receiving waters, should be controlled to prevent unnecessary releases of nutrients. Pesticides and herbicides can cause significant acute and chronic toxic responses in terrestrial and

aquatic ecosystems, but have not been found to be significant pollutants in highway runoff (Kobriger et al., 1984b).

Grass mowing and other vegetative maintenance operations can leave cuttings and other debris along highway shoulders, which can form a thatch layer, reducing infiltration and preventing other vegetative growth. Mowing debris itself does not contribute significant amounts of pollutants to highway runoff. In areas with sparse vegetative cover, leaving cuttings on the ground can reduce erosion, preserve soil moisture, and add organic matter to the soil (Burch et al., 1985b).

6.2 Street Sweeping

Street sweeping has often been considered as a possible means of reducing pollutant loads on highways available for stormwater runoff. Contradictory findings on the effectiveness of sweeping have been reported in several studies of highways and urban streets. The most comprehensive studies have been conducted in urban settings, which may not accurately represent conditions that one might expect in rural areas.

The U.S. EPA (1983) compared results of projects in five cities (including 17 separate catchments), which evaluated street sweeping as a management practice to control pollutants in urban runoff. Researchers on four of these projects concluded that street sweeping was not effective for this purpose. At the fifth site, which had pronounced wet and dry seasons, researchers concluded that sweeping just prior to the rainy season could produce some benefit in terms of reduced pollution.

A large data base was obtained by the EPA on the quality of urban runoff from street sweeping test sites. At 10 study sites selected for detailed analysis, a total of 381 storm events were monitored under control conditions and an additional 277 events were monitored during periods when street sweeping operation were in effect. Analysis of these data indicated that no significant reductions in pollutant concentrations in urban runoff were produced by street sweeping.

The EPA (1983) concluded that the indicated changes in site median Event Mean Concentrations (EMCs) were much more likely due to random sampling than actual effects of sweeping operations. Also, the benefits of street sweeping (if any) were masked

by the large variability of the EMCs, therefore the benefit was certainly not large (e.g., >50 percent), and an even more extensive data base would be required to further identify the possible effect.

Pitt (1979) studied the effectiveness of street sweeping by using wet-dry vacuum units to clean sample strips of test areas before and after sweeping. He also compared the relative strengths of pollutants in the runoff with concentrations in the street dirt samples to determine the extent to which street dirt was responsible for these pollutants. He found that frequent street cleaning on smooth asphalt streets (once or twice per day) can remove up to 50 percent of the total solids and heavy metal yields of urban runoff. Typical street cleaning programs (once or twice per month) remove less than 5% of the total solids and heavy metals in the runoff. Organics and nutrients in the runoff cannot be effectively controlled by intensive street cleaning (typically much less than 10% removal, even for daily cleaning). A cost increase of about a factor of 10 over typical monthly or bimonthly cleaning program costs may be necessary to obtain significant runoff control for heavy metals and total solids. This cost increase may boost the runoff control possible from street cleaning from less than 10% to more than 25%.

Sartor and Boyd (1972) concluded from their research that current street sweeping practices are essentially for aesthetic purposes and that, even under well-operated and highly efficient street sweeping programs, their efficiency in the removal of the dust and dirt fraction of street surface contaminants is low. Further, they found that the very fine material (< 43 microns) accounts for only 5.9% of the total solids but about one-fourth of the oxygen demand and perhaps one-third to one-half of the algal nutrients. It also accounts for over one-half of the heavy metals and nearly three-fourths of the total pesticides. Unfortunately, removal efficiency of this particle size was only 15%.

Maestri et al. (1985b) reported that street cleaning is effective only for large solids and does little to reduce pollutant loads. Pitt and Amy (1973) using data from Sartor and Boyd (1972) showed that less than half of the heavy metal pollutants are removed by street sweeping.

Other studies on the quality of highway runoff have commented on the effectiveness of sweeping. Asplund et al. (1980) states that sweeping can remove 25%-

78% of pollutant mass on highways; however, he presents no data of his own to substantiate that claim. Gupta et al. (1981c) report that sweeping did not have any appreciable effects on the quality of highway runoff.

6.3 Vegetative Controls

Vegetative controls include the grassed swale and vegetated filter (buffer) strips. These controls usually require a sizable amount of land, since they rely on gentle slopes to reduce water velocity thus allowing settling of suspended solids and some infiltration into the subsoil. Therefore, successful use of these vegetated control methods is highly site-specific. Maestri and Lord (1987) identify vegetative controls as the least costly management technique for controlling highway runoff.

Dorman et al. (1988) report that vegetative controls are effective for mitigation of minor storms which produce relatively low velocities and high travel times. Vegetative controls tend to be effective first flush controls because they exhibit the highest pollutant accumulations in the upstream end of the grass channel or overland flow system. Dorman et al. (1988) also report that these controls are particularly effective for the removal of heavy metals within the upstream sections.

Grassed swales are earthen runoff conveyance systems which make use of gentle slopes and wide shallow channels to remove pollutants through filtration by the grass, by some settling, and by some infiltration into the subsoil. Past research indicates that grass species is important to the overall filtering efficiency of swales. Grass density, blade size, blade shape, flexibility, and texture vary by species and influence the filtering efficiency (Umeda, 1988).

Schueler et al. (1991) proposed several swale design criteria including longitudinal slopes less than 6%, permeable subsoils, long swale contact times, swale lengths greater than 200 feet, and dense grass cover. Additionally, the maximum water velocity in the swale should not exceed 1.5 ft/s, and the peak discharge should not be in excess of 5 cfs. Swales operated above these conditions were relatively ineffective at reducing pollution. General costs of swale construction were found to be less than those associated with traditional curb and gutter conveyances, ranging from \$5 to \$15 per linear

foot, depending on swale dimensions. An added benefit of swales is the elimination of the curb and gutter system, which concentrates and transports pollutants in highway runoff.

Schueler et al. (1991) also report a range of pollutant removals for grassed swales. Of 10 swales monitored adjacent to highways and residential areas, 50% demonstrated high to moderate pollutant removal, while the remainder showed negligible or negative removal. The expected removal for well-designed, well-maintained grassed swales is reported as 70% for total suspended solids (TSS), 30% for total phosphorus (TP), 25% for total nitrogen (TN), and 50% to 90% for various trace metals.

Several investigators studied the effectiveness of swales, and the immobilization of metals is commonly reported. Yousef et al. (1985a) found swales to be effective in removing ionic species of metals from highway runoff. Processes involved included sorption, precipitation, co-precipitation, and biological uptake. The effects of flow through swales were quantified in terms of change in concentration between highway runoff and swale outflow for heavy metals. The data in Table 6.1 show mass retention values for both metals and nutrients and indicate the importance of channel length.

Wang et al. (1980) used mass balance studies to show the effectiveness of well-vegetated surfaces in retaining metals from highway runoff at several sites in the Seattle area. They also compared the transport and deposition of heavy metals in a grass channel, a paved channel, and a mud channel and found grass to significantly reduce metal travel distances (see Figure 6.1). Lead was immobilized most effectively; 95% of the lead entering a 24-meter long channel was retained by the soil or grass. Bell and Wanielista (1979) also found that lead was immobilized more than other metals. Some of the concentrations actually increase through certain stretches of the channel. Wang et al. (1980) attribute this to the channel being partially unvegetated and erosion carrying metals to more vegetated sections of the channel.

Simulated highway runoff spiked with the appropriate levels of nutrients and metals was pumped over two swales in central Florida to study mass transport and removal efficiencies (Yousef et al., 1987; Harper et al., 1984). Dissolved metals

Table 6.1
Average Concentrations of Dissolved Pollutants
Flowing over Roadside Swales
(Yousef et al., 1985a)

Pollutant	<u>Maitland Site</u> <u>Channel Length</u>			<u>EPCOT Site</u> <u>Channel Length</u>			
	<u>0.0 m</u>	<u>23 m</u>	<u>53 m</u>	<u>0.0 m</u>	<u>30 m</u>	<u>90 m</u>	<u>170 m</u>
Zn	22	9	3	140	103	77	53
Pb	9	5	9	67	43	41	29
Cu	6	6	5	26	30	29	24
Fe	260	102	81	290	290	261	316
Cr	9	6	8	10	9	10	10
Cd	-	-	-	7	6	5	4
Ni	-	-	-	70	59	47	34
OP-P	368	290	279	580	546	514	530
TP-P	415	367	310	599	586	558	580
NH ₄ -N	1015	870	699	293	321	297	299
(NO ₂ +NO ₃)-N	192	188	167	147	151	147	163
Organic N	842	1337	951	1833	1994	1683	1973
Total N	2049	2395	1817	2273	2456	2127	2435

Average concentration in µg/l

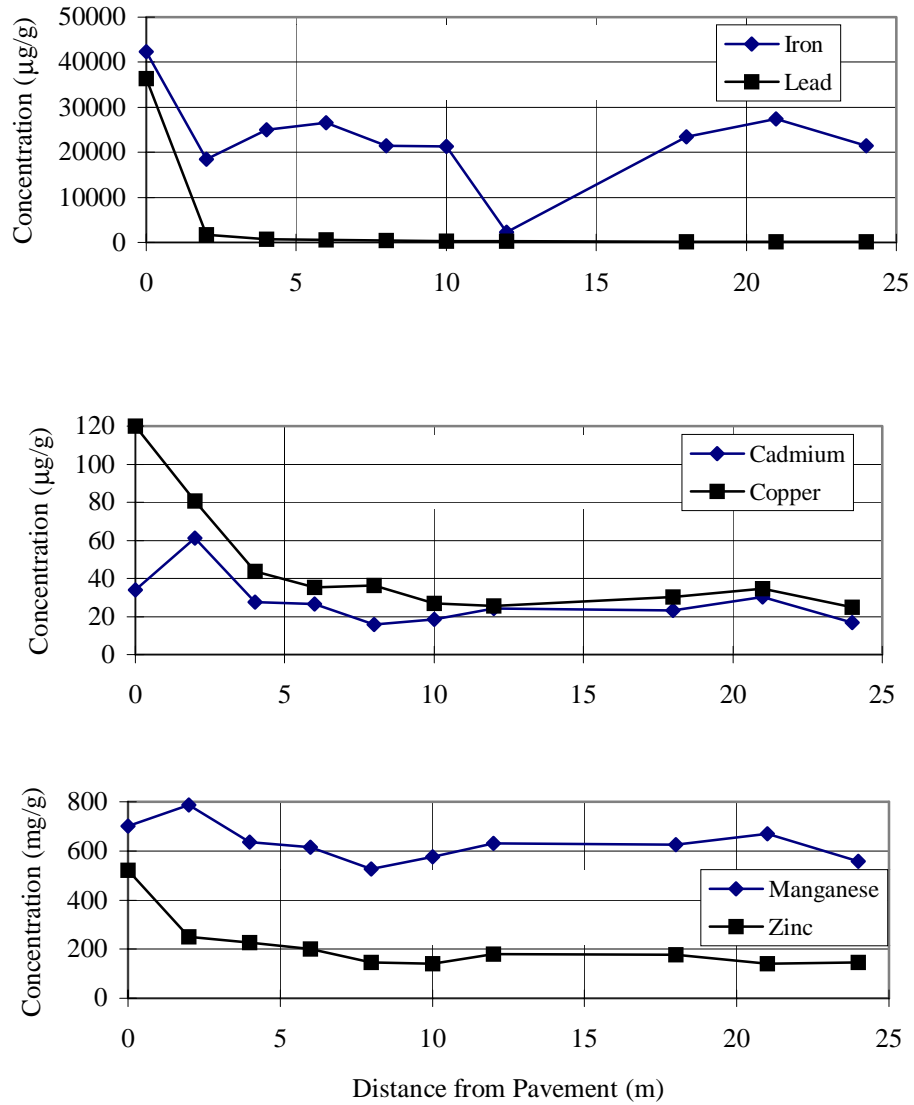

Figure 6.1 Metal Concentration in Surface Soil Near a Highway (Wang et al., 1980).

(particularly ionic species) were more effectively removed in the swales in this study than were nutrients. Harper et al. (1984) report that the removal of heavy metals was found to be closely associated with the pH of the runoff and the corresponding chemical speciation of the metal ions. The presence of organic complexing agents such as humic acid reduced the removal efficiency.

Nutrient concentrations in highway runoff flowing over roadside swales were found to increase at certain times of the year, especially during fall and winter when vegetation growth is decreased and nutrients are released through decomposition of dead plant material (Yousef et al., 1987). Little et al. (1982) found that the concentration of nutrients (total phosphorus, nitrate plus nitrite, and soluble reactive phosphorus) decreased by at least 20% in the summer in a 73-meter channel. Conversely, soluble reactive phosphorous concentrations increased along the length of the channel during the fall of the same year.

Other pollutants also can be removed from runoff through the use of vegetated swales. Little et al. (1982) reported oil and grease removal efficiencies ranging from 67% to 93% in the 73-meter channel mentioned previously. The oil and grease tests also were performed during winter. TSS and VSS concentrations decreased at least 65%, and algal bioassays demonstrated reduced growth inhibition by toxicants in highway runoff when drained through vegetation. Wang et al. (1980) confirmed the effectiveness of swales in reducing concentrations of TSS, VSS, and COD.

Wanielista et al. (1978) conducted an evaluation of 11 field sites to measure the effectiveness of diverting highway runoff to shallow roadside ditches which remained aerobic. Of particular interest was the finding that indigenous, hydrocarbon-utilizing, bacteria populations are up to 90% higher during the rainy months than at other times of the year. Microbial concentrations are greatest near the pavement, decreasing until reaching the roadside ditches. Results of this study indicated a maximum hydrocarbon degradation of only 48% after 60 days along roads with no ditches. Roads with shallow aerobic ditches reached hydrocarbon degradation rates of 99%. Authors recommend leaving grass clippings on the ground to enhance nutrient availability for the hydrocarbon

degrading microorganisms. Additionally, the planting of a nitrogen-enriching legume cover crop, such as clover, can increase nitrogen availability.

Some of the reports offer design suggestions. Yousef et al. (1985a) indicate the importance of channel length (see Table 6.1), as well as the need to reduce velocity of flow. In that report, removal efficiencies at two different swale locations (Maitland and EPCOT) were compared under different flow-through conditions. A decrease in organic nitrogen removal over time was observed. A possible explanation was the increase of organic material deposited in the swale during periods of rapid grass growth. A thin grass cover (< 20%) was preferable to a thick one (>80%), since a heavy grass cover would increase the amount of organic material, effectively lessening the available sorption sites for nitrogen and phosphorous ionic species. The deposited organic material is also available for decay and resuspension in later storms.

Higher infiltration rates also might explain the greater efficiency observed at the Maitland site. Infiltration at the Maitland site ranged from 1.4 to 3.4 in/hr and infiltration at the EPCOT site ranged from 0.5 to 1.3 in/hr. It was determined that swale removal efficiency on a mass basis for the heavy metals, nitrogen, and phosphorus is proportional to increased contact time and infiltration rates. Therefore, swale design should include longer channels with flatter slopes. It should be noted, however, that little nitrogen removal was achieved when the excess runoff exceeded 3 in/hr.

Yousef et al. (1985a) found that the efficiency of swales increased when soils are dry and infiltration rates are high, where lower water tables exist, and when contact time is increased. Thus flat-sloped swales with sandy soils that are high above the groundwater elevation are preferable.

Wanielista et al. (1988a) studied five swale sites (three of the sites were adjacent to highways) in central Florida to determine flow rates and permeabilities. Flow rate was measured using 90-degree V-notch weirs, and a double-ring infiltrometer (adjusted for existing conditions) was used to determine permeability. Descriptions of soil and ground cover for each swale were reported. It was recommended that a design infiltration rate equal to 50% of the value obtained with the double-ring method be used. The flow data indicate that higher runoff volumes result in lower infiltration rates and higher discharge

volumes. Discharge volume decreases when swale length is increased. Swale geometry and slope are also important design features, and the authors present design equations for the construction of swales.

Citing storm data from Florida, Wanielista et al. (1986) show that at least one storm of 1-hour duration that produces 3 inches or more of runoff will occur each year. Since swales in Florida are designed to convey the 3-inch runoff volume as a maximum, the authors propose the use of swale blocks to increase the retention capacity of the swale. Swale blocks are earthen check dams placed transversely across the longitudinal direction of the swale. A swale constructed with swale blocks is presented in Figure 6.2. The miniature detention pools created by the swale blocks increase the swale contact time, providing for increased settling of suspended particles and more infiltration. Design calculations and construction methods for swale blocks are presented in the report.

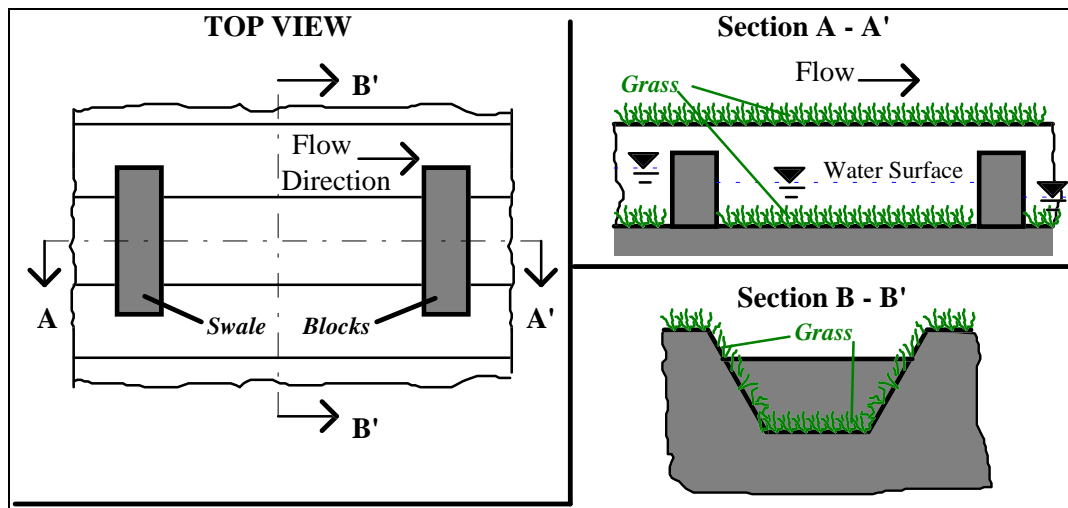

Figure 6.2
Swale Modified With Swale Blocks
(Wanielista et al, 1986)

Several swale blocks were constructed in an existing swale according to the design parameters. After two years, and three storms producing runoff in excess of 3 inches, the swale blocks were still operating. Flows during the large storms had yet to overflow the swale blocks. Swale blocks effectively retained suspended solids, but the authors offered no comparisons to solids retention efficiencies for swales without swale

blocks. Schueler et al. (1991) state that additional investigations are necessary to evaluate such swale design enhancements and their ability to improve pollutant removal and inhibit downstream pollutant migration.

Very little maintenance is required for grass swales. Recommended practices included seasonal mowing, cleaning of trash and debris, and removal of heavy sediment deposits. Schueler et al. (1991) found that the biggest maintenance problem in Washington State was the accumulation of soil and grass alongside the highway edge; runoff was diverted away from the swales. Manual removal of sediments was recommended to preserve the infiltration capacity of the underlying soils (State of Maryland, 1985). Additionally, replanting of vegetation may be necessary. Burch et al. (1985) note that periodic thatch removal or mechanical aeration may be required to restore the original permeability of the soil.

Some concerns and unknown factors about the use of swales are noted in the literature. Umeda (1988) expressed concern about the potential for reduced removal efficiencies during times of summer drought, when vegetation dies or becomes dormant. Schueler et al. (1991) cite several other concerns. Swales in soils that are too sandy may experience side slope stability problems. Also, standing water in swales may create mosquito and odor nuisances. The State of Maryland (1984a) recommends that swale designs allow for a maximum ponding time of 24 hours. Another question to be answered is whether swale performance over longer periods will decline as adsorption sites are used. Finally, swales may adversely affect the groundwater in certain areas, although no subsurface metal enrichment was noted in a study by Wigington et al. (1986).

Vegetated buffer strips, also known as filter strips, are another vegetated control measure. These controls may appear as any vegetated form, grassland to forest, and are designed to intercept upstream flow, lower velocity of flow, and spread out the flow as sheet flow (Schueler et al., 1991). Unlike swales, which are concave conveyance systems, filter strips are fairly level. Filter strips, like swales, require flat slopes (generally less than 5%) and fairly permeable natural subsoils for effective performance. According to Schueler et al., filter strips are best suited for agricultural practices and low land usage areas. Strips are unable to treat high flow velocities, which typically are

associated with impervious areas. Schueler et al. mention a study which evaluated filter strips in an urban environment. Removal for TSS was only 28%; efficiencies for nutrient removal were not reported. Vegetative filter strips used to treat runoff from a parking lot were studied by Glick et al. (1993). They found that pollutant concentrations increased rather than decreased with the width of the strip and attributed this to excess transport capacity of the runoff. Although an inexpensive control measure, vegetated buffer strips are most useful in contributing watershed areas where peak runoff velocities are low.

6.4 Ponds

The use of ponds to treat highway runoff is well-documented. Basically, three types of ponds exist: detention ponds, extended-detention ponds, and “wet” ponds.

Detention ponds are primarily flood control devices, designed to reduce the peak flow associated with large storm events. As such, ponds are designed to be “dry” between storm events. They usually are designed as basins with a fixed orifice outlet pipe that controls the drainage release rate through the structure. These “dry” ponds are usually designed to detain runoff for 1 to 2 hours (Metropolitan Washington Council of Governments, 1983). Several processes have been identified which affect the removal efficiencies of detention ponds (Hampson, 1986). These include interaction with shallow groundwater systems, solubilization of bottom materials, nutrient uptake, seasonal changes in precipitation, and sedimentation. In general, the pollutant removal efficiency of this type of control is minimal (Pope and Hess, 1989).

Extended detention ponds are similar to detention ponds, but are more suitable for improving runoff water quality. As the name implies, these structures are dry ponds with extended detention times. Detention times of up to 24 hours are common, with 6 to 12 hours being the preferred minimum (Schueler et al., 1991). Detention times are increased through the use of adjustable drainage orifices, or by using vertical, perforated riser pipe drains.

Pollutant removal is achieved through the increased detention time which allows the suspended particles time to settle out. The amount of treatment is moderate, but highly variable, depending on detention time and the fraction of the runoff effectively

detained. Reported removals range from 30% to 70% for TSS, 15% to 40% for COD, and 10% to 30% for total phosphorus (Schueler et al., 1991). Soluble nutrient removal rates are low, and sometimes even negative. Schueler et al. state that the treatment efficiencies for smaller storms (i.e., < 0.5 watershed inches) are usually higher than those associated with the larger ones. Lange (1990) also found chloride treatment to be relatively ineffective in dry ponds.

Cole and Yonge (1993) constructed a scale model of a typical detention basin to investigate pollutant removal efficiency. Their experiments indicated that particle removal could be estimated from Type 1 sedimentation theory for an ideal basin. The removal of suspended solids ranged from 65 to 80%. However, removal of metals ranged from 28% to 40% indicating that removal of smaller particle may be necessary to achieve better removal efficiencies for metals.

Dorman et al. (1988) attribute the low, and sometimes negative efficiencies of detention ponds, to the fact that most pollutants associated with highway runoff are allied with the smaller particulate material, which does not have adequate time to settle by gravity in a dry pond. Additionally, the heavier sediments and pollutants which settle during earlier storms may wash out during subsequent rainfall-runoff events. So, the dry basin becomes an effective pollutant source rather than a sink, and the long-term pollution abatement efficiency is low.

The construction cost of dry ponds is generally the least of all the pond options. However, the maintenance burden of these ponds is usually higher. Debris and sediment deposit quickly, requiring more frequent removal, and many of the dry ponds are difficult to mow. Although few of these ponds have been known to fail, the designed detention times are usually much higher than the actual detention times. The inability to predict the actual detention time creates difficulties when attempting to estimate the potential of a dry pond for removing pollutants prior to construction. Chronic clogging of inlets and outlets is often a problems. Downstream warming of natural waters may also adversely affect biota, if the pond is not shaded (Schueler et al., 1991). Since dry ponds are neither reliable nor particularly effective in treating highway runoff, the use of such structures has been deemed ineffective (Dorman et al., 1988).

Wet ponds are considerably more effective at mitigating highway runoff pollution. Maestri and Lord (1987) claim that wet ponds are the best choice for highway runoff treatment if vegetative controls are not feasible. These ponds are designed to maintain a permanent pool of water and to retain a certain amount of storm runoff. Pollutant removal is achieved primarily through the sedimentation of suspended particles and with some biological processes accounting for soluble nutrient reduction. Reported removals have ranged from poor to excellent and are a function of the basin size relative to the contributing watershed and area storm characteristics.

Schueler et al. (1991) report that monitoring studies indicate a range of wet pond removal efficiencies. Reported ranges for removal of TSS, total phosphorus, and soluble nutrients are 50% to 90%, 30% to 90%, and 40% to 80%, respectively. Moderate to high removals of trace metals, organic matter, and coliforms often are reported as well. Yousef et al. (1985b) reported removal efficiencies for a wet pond at a highway interchange having a surface area of about 3 acres and a depth of 1.5 to 2 meters. Removals for dissolved cadmium, zinc, copper, lead, nickel, chromium, and iron ranged from 27% to 63%. The average total removals for the same constituents varied from 47% to 97% of the incoming highway runoff concentrations.

Wanielista et al. (1988b) attempted to determine the removal efficiency of a detention pond for both individual events and for the annual average. Parameters included TSS, inorganic and organic carbon, dissolved metals, and total and fecal coliform. Removal efficiencies for all constituents were significant based on the concentration data. The average concentrations from the pond inlet were compared to average concentrations of a combined pond/outlet value. Removal efficiency was computed for individual runoff events and for yearly average concentration. Some single-event efficiencies are: 45% for organic carbon, 97% for total coliform, 50% for zinc, 49% for copper, 27% for iron, and 37% for lead. Reductions in yearly average concentration between the inlet and the outlet were 42% for organic carbon, 99% for total coliform, 69% for zinc, 60% for copper, 67% for iron, and 31% for lead. However, when mass data are used, the removal efficiencies are negative due to groundwater flow into the pond. Therefore, detention ponds should be designed to minimize groundwater inflow.

Several researchers have developed models to predict the pollutant removal efficiency of detention ponds. Segarra-Garcia and Loganathan (1992) derived a set of equations for computing stormwater detention storage-capacity-treatment rate combinations as a function of pollutant trap efficiency and relevant hydrologic statistics. Toet et al. (1990) described a water quality model that addresses the removal and accumulation of dissolved and particulate constituents as well as processes concerning the yearly cycle of phytoplankton growth and nutrient transformations. The model was used to predict removal of phosphorus and heavy metals.

Of particular importance to wet ponds are quantitative and qualitative measurements of bottom sediments. Sediment accumulation rates are important in determining recommended cleanout intervals. Qualitative investigations of the sediments are necessary prior to selecting disposal options since accumulated metals in sediments may affect the underlying groundwater or be released back into the pond.

Previous results showed that a large portion of the dissolved and suspended heavy metals were deposited in the pond sediments. Yousef et al. (1985b) investigated the potential migration of the metals through the sediment. Their investigation discovered that the top 5 to 6.8 cm of the bottom sediments contained heavy metals concentrations greater than the background concentrations. These concentrations attenuated quickly with increasing depth through the sediment material. It was concluded that upon reaching the pond bottom, heavy metals formed stable associations, remained near the sediment surface, and decreased in concentration with increasing depth. Most of the heavy metals were bound to the iron-manganese (Fe-Mn) oxides and organic matter in the pond sediments. Although most of the lead and cadmium appeared in exchangeable form, the hydrous Fe-Mn oxides served as a sink for the trace metals since aerobic conditions were maintained. Therefore, under aerobic conditions, the potential for trace metal release to solution remained highly unlikely.

Nightingale (1987) studied the distribution of metals in the soils of retention basins that had been receiving urban runoff for a period of at least 15 years. He found that the vast majority of the metals were contained in the top 10 cm of the soil profile, and that below a depth of approximately 24 cm, metals were only present at background

levels. Wigington et al. (1986) also reported that little downward movement of metals occurred in three detention basins they studied.

Investigation of a wet pond's sediment bed over a 7-year period revealed that the sediments served as a sink for both nitrogen and phosphorus (Hvitved-Jacobsen et al., 1984; Yousef et al., 1986). Throughout the monitored period, 99% of the phosphorus input was deposited in the sediments and remained there as a result of the aerobic conditions at the water-sediment interface. The aerobic conditions not only limited more phosphorus release but also increased the top layer of the sediment's sorption potential for more phosphorus. In fact, after one storm, the orthophosphorus concentration in the pond was 130 µg/L, but after approximately three days, the concentration was reduced to 10 µg/L. Additionally, 85% to 90% of the total nitrogen input was removed, most likely through the denitrification process in the lower anaerobic sediment layers where plenty of organic material was available. Ammonia is released by means of denitrification in the sediments and is subsequently nitrified, forming nitrate. The nitrate diffuses to the lower sediment layers and is denitrified. Additional ammonia is released through plant uptake. Since biomass growth in the pond was calculated to be nitrogen limited, the phosphorus build-up should not cause future pond eutrophication.

Disposal methods for accumulated pond sediments are dependent on the concentrations of constituents. Additionally, sediment accumulation rates are useful in determining pond sediment removal intervals. In one study, Yousef et al. (1991) studied nine wet ponds in Florida that received mostly highway runoff. The parent soil in the pond bottom was chosen to represent background conditions. The top sediments showed higher moisture contents, greater organic contents, and lower densities than the soil beneath. Nutrient and heavy metals concentrations were also greater in the sediments than in the soils. Average pollutant concentrations for the sediments and underlying soils are presented in Table 6.2.

The Environmental Protection Agency's (EPA) Toxicity Characteristic Leaching Procedure (TCLP) was performed on the bottom sediments to determine if the deposited sediments were hazardous waste. Concentrations resulting from the TCLP test were

Table 6.2
 Concentrations of Constituents In Wet Pond Sediments
 (Derived from Yousef et al., 1991)

Constituent	Parent Soil	Sediment
Total N (mg/L)	0.41	3.62
Total P (mg/L)	0.32	0.58
Cd ($\mu\text{g/g}$)*	15	5
Cr ($\mu\text{g/g}$)*	61	18
Cu ($\mu\text{g/g}$)*	28	5
Fe ($\mu\text{g/g}$)*	3554	1969
Ni ($\mu\text{g/g}$)*	52	28
Pb ($\mu\text{g/g}$)*	374	67
Zn ($\mu\text{g/g}$)*	161	12

*Dry Wt Basis

much lower than those allowed for hazardous wastes. Additionally, sediments containing increasing levels of silt and clay, as well as increased organic matter content, caused exponential reductions in the sediment TCLP concentrations. Sediment accumulation rates averaged between 1.1 and 4.2 cm/yr (Yousef et al., 1991).

Correlations between sediment accumulation rates and various potential influencing factors were also investigated by Yousef et al. (1991). Relationships between sediment accumulation rate, impervious watershed area, average daily traffic volume, highway area, and other combinations were evaluated. The best correlation was that between the annual sediment accumulation rate and the pond surface area as a percentage of the contributing watershed area. Using a design standard of allowable pool volume reduction due to sediment accumulation of 10% to 15%, the authors recommend sediment removal every 25 years based upon the observed sediment accumulation rates. Yousef and Yu (1992) reported that removal at time intervals of 25 years would also be sufficient to minimize the potential contamination of groundwater.

Maestri and Lord (1987) mention a statistical analysis of wet pond runoff inflows over time. The analysis suggests that detention basin performance can be divided into two distinct periods. The first period is the dynamic period, which occurs during rainfall

runoff events. The second is termed quiescent and is considered the time period between storms. The authors point out that more knowledge of rainfall-runoff relationships, settling velocities of the particles in the runoff, and particle size distributions are necessary in order to facilitate the design of wet ponds to reach pollutant removal objectives.

Haan and Ward (1978) conducted some research on sediment particle size as it relates to sedimentation basins. A predictive model that provides an estimate of a basin's sediment trapping efficiency was developed. The research concludes that the biggest influencing factor for sedimentation is the number of incoming sediment particles in the 5 to 20 micron range, and that particles less than 5 microns in size are unlikely to settle without the aid of a flocculant. The investigators affirm the need to more accurately estimate total sediment load flowing into the basin and to successfully determine sediment particle size distribution.

Wu et al. (1989) evaluated the removal efficiencies of three wet ponds as a function of the pond surface area to contributing watershed area. The evaluated ratios ranged from approximately 0.75% to 7.5 %. At each pond, removal efficiencies for iron, zinc, TSS, total Kjeldahl nitrogen, and total phosphorus were calculated. For all of the measured constituents, removals increased when the pond surface area to contributing watershed area ratio was larger.

Maristany (1989) showed the relationships between wet pond surface area, capacity, and removal efficiencies for total suspended solids (TSS) and total phosphorus. Eleven wet ponds, with contributing watershed areas ranging from 128 to 23,393 acres, and with 9% to 54% impervious area, were evaluated. Treatment efficiencies for TSS and for total phosphorus were calculated using methods promulgated by the EPA and the Corps of Engineers, respectively. These methods required specific storm characteristics and pond dimension data. The phosphorus removal estimate also required data for inflow concentrations of orthophosphorus and total phosphorus. Detailed phosphorus data were not available for all of the ponds, so the same average values were assumed for all of the ponds evaluated. The calculated results show that for a given basin, there is a point of diminishing returns where increased removal occurs at a lesser rate than the rate of

storage capacity increase. Since this point is always reached first for TSS removal, followed next by total phosphorus, Maristany suggests that longer detention times are necessary for increased phosphorus removal.

Wet pond performance as a function of depth was also evaluated. The calculated data show that once the ratio of pond to watershed area exceeds 2%, total phosphorus removal is controlled by the pond depth rather than the surface area. As seen in Figure 6.3, at a 2% ratio, a pond 2 feet in depth removes approximately 40% of total phosphorus, while a 4-foot depth at the same ratio removes about 55%, and a 12-foot depth results in the removal of 70%. Similar, through less dramatic, increases in TSS removals are also evident. Maristany (1989) concludes that these trends indicate that pond deepening may be the most cost effective measure to enhance the performance of a wet pond if excavation costs are less than land acquisition costs.

Martin (1989) performed a tracer dye study under near steady-state discharge conditions to determine the extent of mixing which occurred in a wet pond. The pond has a surface area of about 0.2 acres and a contributing watershed of approximately 42 acres. About 33% of this area is urban highway. The pond is rectangular in shape with a length to width ratio of close to 2:1. Dead storage depth is 8 feet, and the addition of the maximum live storage depth produces a maximum pond depth of 11 feet.

The collected data indicate that the amount of mixing occurring in the wet pond is related to the amount of available live storage space. The larger the available live storage space, the more closely the pond approaches completely mixed conditions, and short-circuiting is decreased. This relationship is even more pronounced for low discharge rates; measured residence times approach the theoretical completely mixed values. However, under high discharge conditions, short-circuiting is more prevalent and residence times are reduced. One tracer dye experiment conducted under high discharge conditions revealed 40% of the particles short-circuiting in less than 6 minutes.

The State of Maryland offers several reasons behind its wet pond design criteria (State of Maryland, 1984b). The design guidelines state that a wet pond's removal by settling in a wet pond is directly related to the pond geometry, detention time, volume,

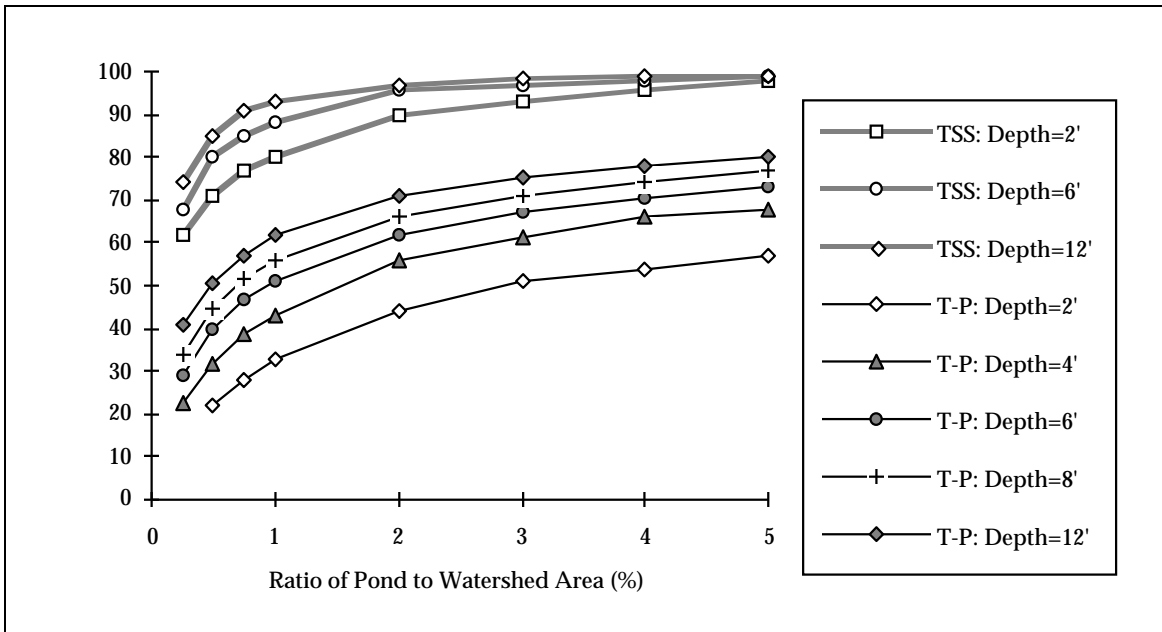

Figure 6.3. Effect of Pond Depth on Wet Pond Treatment Efficiencies for TSS and Total P (Modified from Maristany, 1989)

and the particle size. Gravitational settling occurs when the average velocity in the ponds is less than the critical settling velocity of the particle. Care must be exercised when considering the pond geometry. Inlets and outlets should be positioned in such a way so as to minimize short-circuiting and to promote mixing. Baffles may be positioned in the pond to increase the flow length, if dead space is unavoidable. The Maryland design criteria recommend a 2:1 length to width ratio and a wedge shaped pool, with the inlet at the narrow end. The area ratio is the drainage area divided by the pond surface area, and the volume ratio is the wet pond volume divided by the mean runoff volume. The author presents relationships between the two ratios as they pertain to wet pond performance. Evidence is presented which shows that a smaller area ratio and a larger volume ratio usually will increase pollutant removal performances of most wet ponds. Justification of the 9-day detention time design criteria for wet ponds also is given.

The performance of wet ponds can be enhanced with the addition of alum to incoming stormwater. The alum forms non-toxic precipitates which attract and absorb phosphorus, heavy metals, suspended solids, and bacteria, causing them to rapidly settle from the water column (Harper and Herr, 1992). Alum treatment has been shown to

reduce concentrations of orthophosphorus and total phosphorus by 85% to 95%, heavy metals by 95%, total nitrogen by 50% to 80%, and coliform bacteria by more than 99%.

Costs for wet ponds are definitely higher than for other ponds. Wet ponds usually cost 25% to 40% more than other detention methods (Schueler et al., 1991). Permitting costs for wet ponds may equal or exceed design costs in some cases. Costs also are highly dependent on land acquisition costs. Costs per unit area treated generally decrease with increasing contributing watershed area (Burch et al., 1985a). According to Schueler et al. (1991), annual maintenance costs range from 3% to 5% of construction costs. Maintenance typically consists of inspections, trash and debris removal, and mowing of embankments. Additionally, sediments must be removed as necessary, as failure to do so will decrease long-term performance. To date, very few wet ponds have failed. Well-designed ponds may last over 20 years.

Schueler et al. (1991) also list some additional considerations associated with wet ponds. Ponds are not useful in regions where the annual evapotranspiration rate exceeds the annual precipitation. Additionally, dry weather baseflow assists in maintaining the wet pool elevation and preventing stagnation. If not properly sited, wet ponds may cause downstream warming, although the downstream impacts of wet ponds are not fully known. Nutrient releases from pond sediment over time also have not been fully evaluated. Further studies investigating the trace metal uptake by wet pond biota (especially fish) are needed.

6.5 Wetlands

Wetlands that treat highway runoff are designed as shallow pools which create growing conditions conducive to marsh plant growth, maximizing pollutant removal through plant uptake (Schueler et al., 1991). Unlike constructed wetlands for wastewater treatment and NPDES requirements, storm runoff wetlands are not designed to replicate all of the natural wetland ecological functions. Pollutant removal is achieved primarily through wetland plant uptake, physical filtration, adsorption, gravitational settling, and microbial decomposition. Wetlands have the ability to assimilate large quantities of dissolved and suspended solids and exhibit a high nutrient demand (Dorman et al., 1988).

Wetlands are particularly useful at removing BOD, TSS, and heavy metals. Nutrients also are removed, but rates are highly variable. Overall, treatment efficiencies of wetlands are similar to those associated with wet ponds (Schueler et al., 1991). Additionally, the degree of treatment is dependent on the surface area to volume ratio, treatment volume, and the ratio of wetland surface area to contributing watershed area.

Dorman et al. (1988) provide additional wetland design guidance. A relatively long retention time (6 to 14 days) is the most important factor in removing heavy metals and other toxicants. Shallow water with a low basin gradient to slow the flow also is important. This configuration assists in maximizing the contact time between runoff and wetland vegetation and soils. Sufficient size to store the design storm runoff volume is also necessary. Finally, inlets to wetlands should be designed to eliminate or minimize the erosion potential. Wetlands for treating highway runoff are relatively new, and very little performance data is available.

Schiffer (1988) documented the reduction in the concentration of automobile-related chemicals between the inlets and outlets of wetlands. The greatest removals evaluated were those for lead and zinc, averaging 80% and 53%, respectively.

Increased costs for wetlands are usually associated with the increased land area necessary for their construction (Schueler et al., 1991). Often, wetlands require two to three times the space required for other control methods. Design costs are slightly higher than those for wet ponds, usually due to required environmental analyses. Construction costs should be slightly higher than for wet ponds, because of the use of special planting techniques. Wetlands generally require intensive maintenance to establish the marsh during the first 3 years. After this time, maintenance is similar to that associated with other ponds. Typically, annual maintenance costs should be about 3%-5% of construction costs. Well designed wetlands should last for many years, the oldest ones in existence today are less than 10 years old.

Schueler et al. (1991) highlight some concerns pertaining to wetlands. Wetlands are difficult to establish in sandy soils or in soils with high permeabilities. Additionally, wetlands may not work well in areas with high evapotranspiration rates. Wetland performance is greatest during the warmer months, which are associated with the growing

season. The extent to which removal rates are reduced during the colder months is unknown. Also, the annual dieback of wetland plants may generate a pulse of nutrients in the outflow. Annual harvesting of plants may increase removal rates, but this practice needs to be evaluated. Biota uptake of heavy metals may also be a concern.

6.6 Infiltration Practices

Infiltration practices are designed to contain a certain volume of highway runoff. The runoff is treated as the water percolates into the underlying subsoil or through a prepared porous media filter bed. Infiltration structures include porous pavements, wells, trenches, and basins.

Porous pavements consist of a thin coat of open-graded asphalt placed over a base of crushed stone. Runoff water is held in the pore spaces until it percolates through the sub-base or drains laterally through underdrains. Chronic clogging of porous pavements is common. Since a dry sub-base is essential to good highway design, these structures are ineffective for treating highway runoff and are recommended for use only in parking lots and low-volume trafficways (Maestri and Lord, 1987).

Infiltration drainage wells are useful in intercepting runoff, treating it, and recharging the groundwater. Jackura (1980) describes the use of drainage wells to drain highway surface runoff in California beginning in the 1960's. A typical schematic of a drainage well appears in Figure 6.4.

The two major types of drainage wells are the open-end casing (with or without perforations) and the closed-end casing. Wells must extend through impervious strata and terminate a minimum of 10 feet above the groundwater, unless the runoff has been treated. Usually, gravel and/or sand is mounded around the drainage inlet to filter the incoming water. It is much easier to replace the mounded filter media than it is to replace an entire well. Construction and operating costs of drainage wells are high, based on a unit volume of water drained, in comparison to other infiltration practices. Air jets usually are used to rejuvenate the pore spaces adjacent to the well casings. The risk of

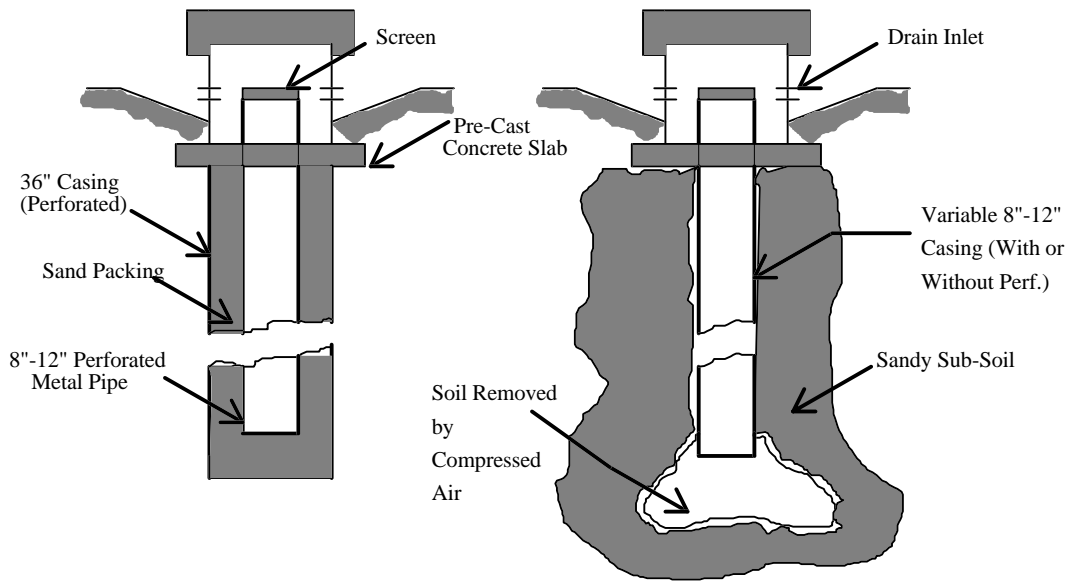

Figure 6.4 Drainage Well Installations
(Modified from Jackura, 1980)

groundwater contamination also is higher with drainage wells compared to other infiltration practices; therefore, use of wells for highway runoff is not highly recommended.

The State of Maryland (1984a) designed a drainage well for use with a highway curb and gutter inlet. An example of the structure is shown in Figure 6.5. The well is 3- to 12-feet deep and requires a minimum soil percolation rate of 0.27 in/hr. The authors state that the longevity and performance of the structure are not well documented.

Infiltration trenches and basins are the classic infiltration systems associated with highway runoff. Often, these devices are termed “retention” structures since the runoff water is essentially retained. The design storm runoff volume is captured by the device and slowly exfiltrates through the bottom and sides of the structure. The exfiltrated water passes through the sub-soil and eventually recharges the water table. Pollutant removal is primarily through sorption, straining, and microbial decomposition in the underlying soils (Schueler et al., 1991).

Very few monitoring studies have evaluated infiltration practices. Estimates of the effectiveness of infiltration systems are derived primarily from rapid infiltration tests

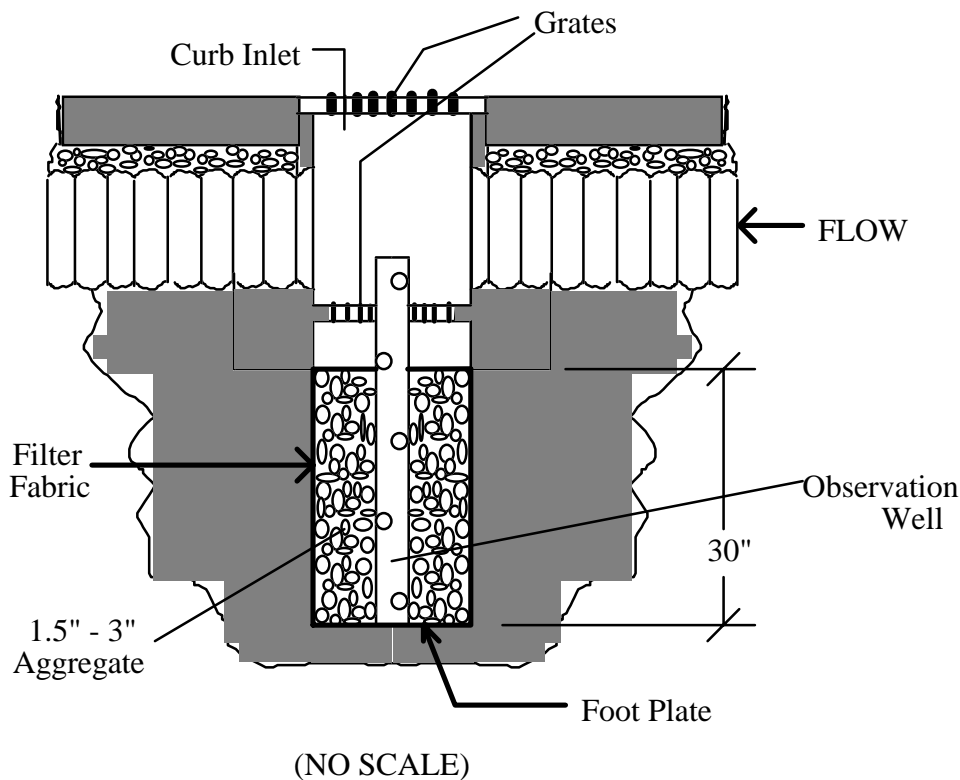

Figure 6.5 Curb Inlet Dry Well
(Modified from State of Maryland, 1984a)

on land-applied wastewater treatment systems and through modeling. Schueler et al. (1991) report estimated sediment removals greater than 90%, and phosphorus and nitrogen removals of about 60%. Removals of approximately 90% of coliforms, trace metals, and organics can be anticipated. Lower removal efficiencies for chlorides, nitrate, and soluble trace metals are anticipated, particularly in sandy soils. Increased levels of organic material in the soil can increase the removal efficiencies.

The fact that these structures provide recharge to the groundwater, instead of discharge downstream, makes them a useful tool for restoring pre-development groundwater conditions and for reducing downstream flooding and erosion. As such, infiltration controls are the structural methods of choice in Florida and Maryland (Dorman et al., 1988).

Infiltration devices (i.e., trenches and basins) are highly dependent upon site conditions. Schueler et al. (1991) affirm that most sites will require an on-site geotechnical investigation to ascertain infiltration feasibility. A wide range of minimum site criteria values appears in the literature. The important criteria include the saturated soil infiltration rate, maximum allowable dewatering time, minimum distance between facility bottom and underlying water, bedrock, or confining layer, and topographic features. The minimum saturated soil infiltration rate most commonly cited is 0.5 in/hr (Schueler et al., 1991), but values as low as 0.3 in/hr also are reported (Dorman et al., 1988). Maximum allowable dewatering rates are a function of the statistical evaluation of the average time between rainfall events for a given meteorological region (Dorman et al., 1988).

The infiltration devices should be designed to dewater completely between storms. Harrington (1989) states that this drying allows the soil pores to rejuvenate and prevents sealing of the soil pores as well. Burch et al. (1985a) assert that algal growth in porous media is best controlled by allowing the media to dry between storms, particularly during the warmer months. Maryland and Florida design for a 72-hour maximum dewatering period (Dorman et al., 1988).

Minimum depth to the underlying water or confining layer is important with respect to groundwater contamination. Enough contact time must be allowed for percolating runoff so that the potential for groundwater contamination is minimized. Typically, this value is dictated by the regional depth to the water table (Dorman et al., 1988). Values range from 3 feet to 10 feet, with eastern states generally opting for 2 to 4 feet due to shallow water tables, and western states closer to the 10-foot minimum standard. Steep slopes also may prohibit infiltration practices. The range of maximum allowable slopes reported is 7% (Dorman et al., 1988) to 5% (Schueler et al., 1991). Infiltration structures also should be located a minimum of 100 feet from water supply wells (Schueler et al., 1991).

Although the treatment methods and efficiencies associated with infiltration trenches and basins are essentially the same, applications, designs, and costs are quite different. Infiltration trenches are best suited for smaller watersheds. Harrington (1989)

recommends the use of trenches on watersheds less than 10 acres, but a more commonly reported size is 5 acres or less (Schueler et al., 1991; Dorman et al., 1988).

A typical cross section of an infiltration trench is presented in Figure 6.6. An important aspect of this design is the inclusion of the observation well with a removable cap. Harrington (1989) says that this feature allows for inspection of the trench to determine if it is functioning properly and facilitates the evaluation of the drain time between storms. The use of filter fabric around the stone reservoir and approximately 1 foot below the trench surface also prevents the migration of fines into the larger pore spaces and prevents clogging failures. Buffer strips at least 20 feet wide on each side of the trench assist in coarser sediment removal.

Clogging failures are common for infiltration trenches. A survey in Maryland found that the oldest working infiltration trench was 5 years old (Schueler et al., 1991). The same survey discovered that 20% of the trenches did not operate as designed immediately after construction. Less than 50% of the surveyed structures were operating properly after 5 years. Approximately one-third showed signs of chronic clogging. Construction practices and maintenance activities were most responsible for failure or reduced performance.

The State of Maryland (1985, 1986) provides specific construction and maintenance guidelines that are known to improve an infiltration structure's longevity and performance. Areas where infiltration facilities are to be built should be surveyed and roped off prior to any construction in the area to prevent vehicular traffic from compacting the underlying soils. Trench excavation should be done with a backhoe, wheel or ladder type trencher. Bulldozers and scrapers may seal the soil pores with their weight and/or equipment blades. Runoff should be diverted away from the facility until all adjacent construction is complete and all surrounding slopes are stabilized with vegetation to prevent erosion. The trench should be inspected for any roots or other objects which could puncture the filter fabric. Finally, each trench should be inspected at least once annually after a major storm to see if it is draining at its designed rate.

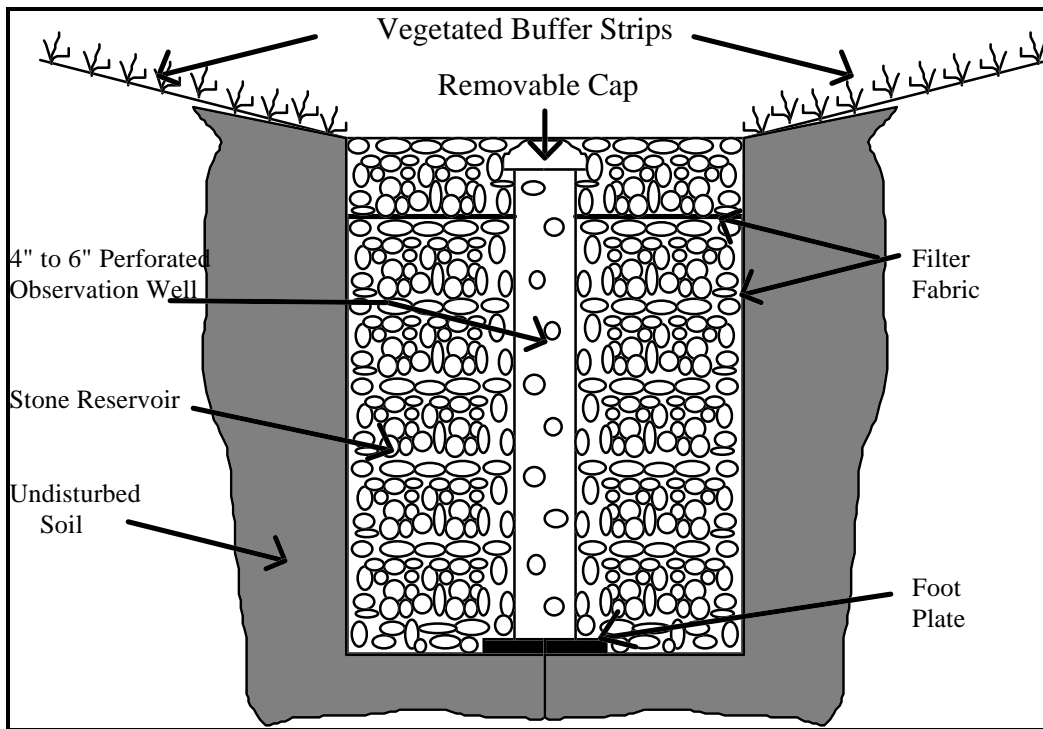

Figure 6.6 Infiltration Trench Cross Section
(Modified after Harrington, 1989)

Yim and Sternberg (1987) conducted a comprehensive study of infiltration trenches in an attempt to refine infiltration trench design criteria. Of particular interest was the use of a granular filter medium on top of the trench base soil. The granular filter was believed to assist in maintaining the original permeability of the soil by trapping the finer sediments. An optimum grain size for the granular filter medium exists for a given infiltration rate. The general relationship is the higher the infiltration rate, the lower the required grain size to effectively filter out the fine sediments. Various empirical relationships for sizing the granular filter media are provided. For infiltration rates ranging from 0.016 to 0.645 cm/s, optimum granular filter media sizes were determined and found to maintain about 50% of the underlying soil's original permeability after about 7.5 years of service. Trenches with no granular filters and subjected to the same loading rates experienced an approximate one order of magnitude reduction in base soil permeability after the same time period. The use of the granular filter effectively increased the life of the facility by a factor of two. Finally, the addition of the granular

filter increased the sediment removal efficiency of the trench by about 40% to 45% under uniform sediment loads compared to the trench with no granular filter.

Stahre and Urbonas (1989) describe the success of infiltration facilities (both trenches and basins) in Sweden. A more conservative design approach than is currently practiced in the U.S. provides more effective infiltration facilities in Sweden. The authors point out that when intensity-duration-frequency (I-D-F) curves are used to estimate design storm runoff (as is often the case in the U.S.), only the most intense portions of the storms are considered. The “tails” of rainfall before and after the intense period are omitted. However, an effective infiltration facility must be designed to hold all of the runoff associated with a design storm. A previous Swedish study determined that an adjustment of 25% to the Rational Formula improved runoff predictions for the sizing of infiltration facilities.

Another conservative approach used is to divide the field-determined infiltration rates by a safety factor of 2 or 3, in recognition of the fact that the soil pores will clog over time. When calculating infiltration areas of pits and basins, the floors are considered impervious. Only infiltration through the walls is considered. All of these design measures have greatly increased the longevity and performance of Swedish infiltration structures. Stahre and Urbonas (1989) present several design examples as well.

Kuo et al. (1989) developed a finite element model to simulate transient flow of water in a variably saturated porous medium. Pressure heads and soil moisture content distributions in the soil surrounding an infiltration trench were calculated, as were fluxes across the boundaries. The predicted values using the model compared well to the experimentally measured values. Geometric design of trenches was found to be important. The infiltration rates for deep narrow trenches are higher than those which are shallow and wide, due to higher pressure heads in the deeper trenches. However, the larger horizontal surface area of the wide shallow trench allows a greater volume of water to infiltrate.

Costs for infiltration trenches are generally greater than pond systems, especially when based on unit of runoff per volume treated basis (Schueler et al., 1991). However, trenches are suitable for smaller watersheds where ponds cannot be used. A significant

portion of design costs are incurred during the site investigation. Future EPA regulations concerning groundwater injection may require a permitting procedure. Limited maintenance costs are available. Based on the available data, if adequate maintenance procedures are ignored, trench rejuvenation or replacement may be required every 10 years. Such a cost could approach the original construction cost.

Schueler et al. (1991) also mention several areas pertaining to infiltration trenches that require additional investigation. Pre-treatment systems should be evaluated to determine the most effective method of increasing trench longevity. Effective maintenance routines and schedules are necessary to increase trench performance. The removal efficiency of trenches located in sandy soils with shallow water tables needs evaluation. Finally, infiltration trench performance under freezing and snowmelt runoff conditions is unknown.

Infiltration basins operate in a manner similar to trenches, but with a few exceptions. One difference is that the runoff storage volume in infiltration basins is primarily ponded water in the basin. Most basins capture the runoff from a specified design storm. Usually, this amount is the first 1/2 inch associated with the first flush. Any additional runoff is either diverted to other discharge devices or overflows the top of the basin via an overflow spillway. These two different systems are commonly referred to as “off-line” and “on-line” basins, respectively (Schueler et al., 1991). The increased surface area for exfiltration from the basins provides more potential for groundwater recharge than other infiltration techniques. Basins are also applicable to larger contributing watershed areas. Schueler et al. (1991) cite a range of 2 to 15 acres, while Dorman et al. (1988) state an upper limit of 50 acres. In aquifer recharge zones, infiltration basins have successfully treated moderately polluted runoff (Whipple et al., 1987). However, in areas where chronic oil spills are possible, or in areas of sole-source aquifers, the use of infiltration basins should be carefully reviewed (Schueler et al., 1991).

To date, most infiltration basins have failed due to rapid clogging (Schueler et al., 1991). Of those investigated, 60% to 100% could no longer exfiltrate water after 5 years. Once basins are clogged, it is nearly impossible to restore their exfiltration capacity. Many are converted to wet ponds or wetlands. Large sediment inputs, large contributing

watershed areas, and long dewatering times adversely affect the pollutant removal performance and decrease the basin's life. Deep pools of standing water should be avoided since this tends to cause soil compaction. Control measures that reduce sediment input to the basin and/or off-line systems that bypass large storms with high sediment yields are also beneficial. Lining the basin floor with sand and installing back-up underdrains is another useful technique.

Aside from using the construction and maintenance techniques previously mentioned for infiltration trenches, several additional methods can be applied to infiltration basins. Burch et al. (1985a) state that sediment should be removed from basins only when they are dry and that light tractors should be utilized to minimize soil compaction. Additionally, the authors recommend tilling the basin bed once per year with a disc harrow or rotary tiller, after sediment removal, to maintain the basin's exfiltration capacity.

Costs for infiltration basins generally range 10% to 20% higher than those of dry ponds (Schueler et al., 1991). Costs may increase significantly depending on improvements made to increase the basin life. Design costs involve substantial site investigation expenses. As with infiltration trenches, future EPA regulations may require a groundwater injection permit. Annual maintenance costs are projected to be about 5% of construction costs. However, reported maintenance costs are higher due to conversions to wetlands or ponds.

Additional studies are necessary to establish the effects of temporary deep ponding on the clogging of infiltration basins (Schueler et al., 1991). Pretreatment controls that can lengthen basin life also should be assessed. The risk of groundwater contamination and the performance of infiltration basins under freeze/thaw conditions also require study. Finally, more evaluations of actual infiltration basin pollutant removal efficiencies are necessary, particularly for soluble nutrients.

Lange (1990) evaluated several forms of highway runoff treatment practices used in the Federal Republic of Germany (FRG) for their impact on groundwater contamination. Groundwater below infiltration basins showed increases in certain inorganic constituents but at levels still below the standards set for drinking water.

Organics deposited in the basins were sorbed by the natural soils, or degraded by indigenous microorganisms. Chloride concentrations were the only constituents which sometimes exceeded the drinking water criteria. As a result, the FRG authorized infiltration practices for treating highway runoff; even in areas near water resources.

Armstrong and Llena (1992) used fate and transport models for chemicals in soils and aquifers to assess the potential of contaminant leaching from soils that are beneath infiltration structures. Their work provided a general evaluation based on existing knowledge of pollutant properties and transport characteristics. Groups of organic (32) and inorganic (7) pollutants were selected for study based on their presence in runoff. By coupling the estimated distribution coefficient (K_d) and retardation factor (R_f) of a pollutant values with water loading and infiltration rates, predicted leaching rates were estimated. Results were presented as pollutant mobility index classifications. The indices were based on the calculated pollutant leaching rate relative to the water infiltration rate. The results also included estimated residence times of pollutants in specific types and depths of soils. Chemicals with K_d values less than 10 mL/g could move through the soil at a rate greater than 1% the rate of a non-retained chemical. Twenty-four chemicals were mobile when the soil organic content (f_{OC}) was less than 0.01%, but when the f_{OC} value was increased to 1%, only 9 chemicals remained in the same classification. Most of the remaining 9 had octanol-water partition coefficients (K_{OW}) less than 10^3 .

The model showed that inorganic pollutants are significantly less mobile than the organic compounds. The experimental published data for two “typical” soils were the basis for K_d values used in the evaluation of inorganic mobility. At low pollutant loading rates, no organic constituent received a mobile or intermediately mobile classification. At higher loadings, most inorganics displayed a low mobility ranking; expected migration was 0.1% to 1% of a conservative chemical. Accuracy of the inorganic mobility is dependent on how well the soils beneath the infiltration facility represent the “typical” soils used in the mobility evaluations. Even when the f_{OC} value was 1%, a fairly high value, several polar pesticide compounds were predicted to be fairly mobile.

Infiltration site selection should minimize the potential for pollutant leaching by considering such factors as soil type, depth to groundwater, and water loading rate. For high loading rates, a few meters of soil beneath the facility will probably provide insufficient protection. Soils with high organic content can reduce leaching potential.

6.7 Filters

Sand filters are a relatively new treatment device for highway runoff (Schueler et al., 1991). Actually, the concept is similar to that of an infiltration basin, except that the treated water is discharged downstream rather than into the groundwater. The first flush of storm runoff is detained in the surface impoundment, which has a sand bottom covering drainage collection pipes. The bottom of the impoundment is impervious (i.e., concrete) or relatively impervious. Runoff is filtered through the sand, collected by the drains, and discharged downstream. A typical sand filter is illustrated in Figure 6.7.

Both on-line and off-line systems exist, but off-line systems work best since the larger storms with heavier sediment loads are bypassed. Pollutant removal is achieved

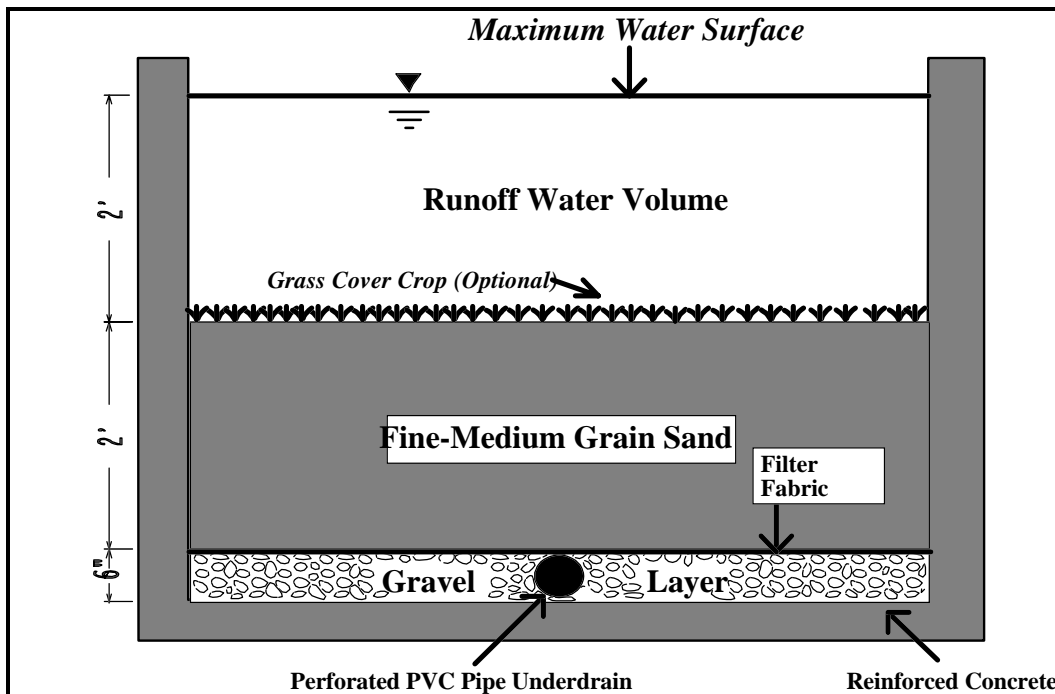

Figure 6.7 Typical Sand Filter Cross-Section

primarily by straining through the porous media and through gravitational settling on top of the sand bed. Removal rates are high for TSS and trace metals and moderate for BOD, nutrients, and fecal coliforms. Nutrient removal can be increased through plant uptake if a cover crop is planted on top of the sand layer.

Most of the sand filters in place today are in the Austin, Texas area. Performance results have been good. Three sand filters in Austin have shown 85%, 35%, 40%, 40%, and 50% to 70% removal efficiencies for sediment, total nitrogen, dissolved phosphorus, fecal coliforms, and trace metals, respectively (Schueler et al., 1991).

Sand filters are useful in areas with thin soils, soils with low infiltration rates, and areas of high evapotranspiration (Schueler et al., 1991). Sand filters also pose little threat of groundwater contamination and are useful in areas of limited space. Most sand filters have contributing watershed areas of 0.5 to 10 acres, with a maximum of about 50 acres. A minimum sand bed thickness of 18 inches and a drawdown time of 24 to 40 hours are necessary for effective pollutant removal. Head required to effectively operate the sand filters has usually been 2 to 4 feet. Of the approximately 1000 sand filters in place in the Austin area, public works officials state that most are performing as designed and few have failed. The oldest filter is about 10 years old.

The construction costs of sand filters range from \$3 to \$10 per cubic foot of runoff treated (Schueler et al., 1991). This cost is about 2 to 3 times the cost for similarly sized infiltration trenches. One reason for increased costs is the use of structural concrete for the filter. Frequent (i.e., quarterly) manual maintenance is required, consisting primarily of raking, leaf removal, trash and debris removal, and surface sediment removal and disposal. Surface sediments from Austin's sand filters have been analyzed and can be safely landfilled. Since most maintenance is performed manually, the sand filter should be designed for easy access. Maintenance costs are estimated to be 5% of construction costs per year.

Some drawbacks and unknown qualities pertaining to sand filters do exist. Schueler et al. (1991) assert that sand filters provide very little flood control benefits. Sand filters also may appear unsightly, if no cover crop is planted. Odor problems have been associated with some sand filters. The impact of sand filters on downstream

warming and their performance in colder climates should be evaluated. The frequency of surface sediment removal also requires further investigation. Finally, additional media combinations which could increase nutrient removal should be studied.

Welborn and Veenhuis (1987) evaluated a sand filter in Austin, Texas. The structure is an on-line system that treats runoff from an 80-acre site, of which about half is impervious parking lots and roads. The sand bed consists of an 18-inch fine sand top layer, followed by a 12-inch coarse sand intermediate layer, followed by a 6-inch gravel layer with 6-inch perforated pipe underdrains. The pond bottom is lined with a 24-inch clay liner. The maximum pond depth is 14 feet, and the storage capacity is 3.5 acre-feet. A total of 22 storm events were monitored over a 2 year period, with total rainfall ranging from 0.14 to 2.88 inches. All inflow to the device was filtered through the sand beds, except for three large storms which crested over the emergency spillway. Peak outflow from the filter was measured at 3.1 cfs. Average discharge rates tended to decrease during the duration of the study, as the sand bed became clogged. The filter was cleaned twice during the study, which caused peak and average discharge rates to improve, but not to the levels achieved when the filter was new. Peak and average discharges also lessened noticeably after larger storms, most likely due to the larger sediment loads associated with the storms.

The sand filter system was efficient in removing bacteria, suspended solids, BOD, total phosphorus, TOC, COD, and dissolved zinc. Average removals ranged between 60% and 80%. The average total dissolved solids (TDS) load was approximately 13% greater in the outflow than in the inflow. Possible explanations for the increase were the dissolution of previous deposits left on the filter, leaching from the pond bed and sand filter, and mineralization of the organic material deposited on the pond bed. Organic nitrogen and ammonia nitrogen concentrations in the inflow were substantially larger than that in the outflow. Total nitrate plus nitrite levels in the outflow were about 110% larger than the inflow concentrations. These measurements indicate that nitrification occurs in the pond.

Edwards and Benjamin (1989) described the use of a coated sand for enhanced metals removal. Their filtration experiments demonstrated that an iron-hydroxide-coated

sand outperformed uncoated sand in removing particulate metals, as well as both uncomplexed and ammonia-complexed soluble metals. Removed metals were effectively recovered from the coated media during backwashing and acid regeneration.

Galli (1990) describes an enhanced sand filter design which incorporates peat into the filter material. Peat is a highly organic, complex material which is primarily composed of cellulose and humic and fulvic acids. Its structure ranges from open and porous to granular and colloidal-size. The porous peats tend to have the highest water-holding capacities. Measured hydraulic conductivities of peat range from 0.025 cm/hr to 140 cm/hr. Low bulk densities are also common. Peats also exhibit a high buffering capacity. The adsorptive surface area reportedly is 2 to 4 times that of montmorillonite clay. Peat also maintains a high cation exchange capacity which is particularly good for copper, zinc, lead, and mercury. The carbon:nitrogen:phosphorus composition ratio of peat is around 100:10:1, providing substrate for microbial growth. Pure peat materials typically contain large populations of nitrifying and denitrifying organisms. Although phosphorus assimilation in peat has been reported, phosphorus retention in peat appears to be more closely linked to the calcium, aluminum, iron, and ash content in the peat. All of these qualities make peat a useful additive for sand filters.

Galli points to earlier studies which evaluated the effectiveness of peat for sewage treatment. Removals were high (i.e., greater than 80%) for nutrient, BOD, and pathogenic bacteria. Peat has also been effectively used to treat electroplating wastewaters and to clean up oil spills. The peat-sand filter was first tested in the early 1970's, consisting of a 10- to 30-cm peat layer on top of a 75- to 90-cm layer of fine sand. Grass was planted on top of the peat. Removals achieved were greater than 90% for phosphorus, 98% for BOD, and 99% for fecal coliforms. Improvements since then include a multi-layered design. The top layer is 12- to 18- inches of peat with calcitic limestone mixed in to enhance phosphorus removal. The middle layer is a 4-inch thickness of a 50% peat/50% sand mixture. This layer assists in providing a uniform flow through the bed and helps to increase the peat-water contact time. The bottom layer is a 6 inch gravel layer with a perforated PVC pipe underdrain.

A peat-sand filter has been constructed in Maryland where an existing off-line infiltration basin failed. The contributing watershed area is 140 acres. Although removals have not been evaluated, estimated removal efficiencies for TSS, total P, total N, BOD, trace metals, and bacteria are 90%, 70%, 50%, 90%, 80%, and greater than 90%, respectively. Since the peat-sand filter performs best during the warmer months, a wet pond precedes the filter in order to provide limited treatment during the winter when the peat-sand filter is bypassed. The pond also provides some sediment removal.

Design requirements for sizing peat-sand filters for treating runoff are not rigid. Generally, an increase in the areal pollutant and hydraulic loadings corresponds to an increased requirement for the peat surface area. One general rule of thumb provided is that 0.5 hectares of peat surface area is required for each 100 hectares of contributing watershed area treated. Galli stresses the importance of analyzing peat for hydraulic conductivity, cation exchange capacity, iron, aluminum, calcium carbonate, ash, and nutrient content prior to bulk purchase. He notes that negative nutrient removal may also be experienced during filter start-up as some nutrients may wash out from the peat.

Known maintenance requirements for peat-sand filters include trash and debris removal, sediment removal, and grass cover mowing and clippings disposal.

More research is required pertaining to the amount of sediment which can be deposited on peat before filter efficiency is diminished. The effects of different peat hydraulic conductivities on overall removal efficiencies are also unknown. The sizing relationships for designing peat-sand filters also must be studied. The effects of optimum peat mixtures and thicker peat depths on performance and longevity also require investigation.

6.8 Performance Enhancements

Several performance enhancements for highway runoff controls are mentioned in the literature. These enhancements are primarily structural additions to pre-treat the influent or to polish the effluent, but effective maintenance management measures can also increase the pollutant removal capability and longevity of a structure (Schueler et al.,

1991). Specifically, oil/grit treatment and separators, sediment forebays, and granular activated carbon (GAC) filters will be discussed.

6.8.1 Oil/Grit Treatment

Oil and grit chambers are often used in conjunction with highway runoff controls to remove heavy particulates and adsorbed hydrocarbon particulates (Schueler et al., 1991). These structures cost around \$8000 per unit, which is 3 to 4 times the cost per unit volume of treated runoff associated with infiltration trenches. Berg (1991) mentions that these structures are intended for small contributing watersheds, usually 1 acre or smaller. Frequent maintenance and cleanout are recommended on a quarterly basis and the associated operating costs are high. Of 500 constructed in Maryland, only a few have been properly maintained, causing retained oil and sediments to be released downstream during intense storms. If properly maintained, these systems can function as pre-filtering devices for other runoff controls.

Silverman and Stenstrom (1989) acknowledge the relative ineffectiveness of oil and grit chambers. They cite studies which showed that 40% to 60% of oil and grease associated with urban runoff is in a dissolved or colloidal state. Thus, the classic oil and grit separators which are designed to separate free-floating oil and grease products would exhibit low removal efficiencies for urban and highway runoff. According to Schueler et al. (1991), actual removal efficiencies for water quality inlets used as runoff controls have yet to be studied. Silverman and Stenstrom (1989) show that the most effective treatment for oil and grease in highway runoff is one of source reduction. The use of porous pavements, greenbelts, storm drain inlet adsorbents, and wet pavement scrubbing are all shown to provide beneficial oil and grease reduction.

Kile and Wendland (1989) designed a pre-cast concrete sedimentation/filtration system for curb and gutter inlets. A schematic diagram illustrating the design features is presented in Figure 6.8. The two box chambers at the inlet serve as sediment traps prior to the filtration chamber. The 6 ft x 6 ft x 6 ft concrete filtration chamber has a PVC underdrain beneath 18 inches of sand, followed by filter fabric, with 6 inches of sand on

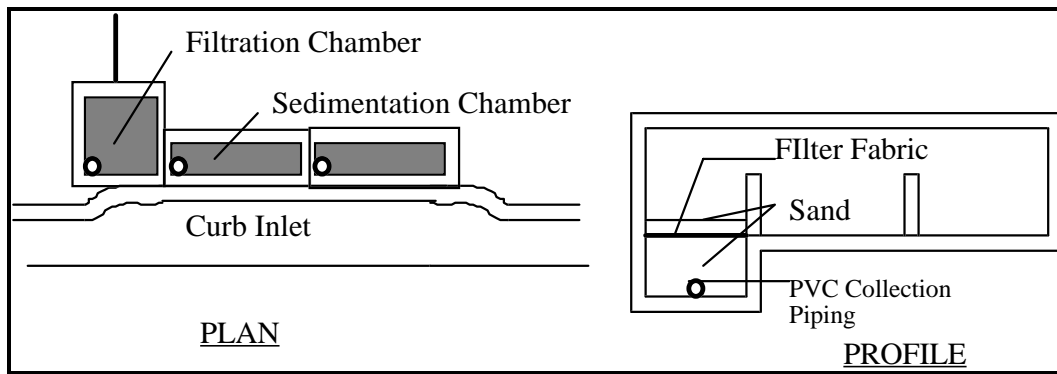

Figure 6.8 Moduled Sedimentation/Filtration Chambers
(Modified from Kile and Wendland 1989)

top. The authors offer no expected pollutant removal efficiencies or recommended maintenance practices for this device.

6.8.2 Sediment Forebays

Forebays are useful devices for enhancing the performance of most runoff control devices. They provide an extra storage space, or pool, prior to the inlet of the runoff control device and remove a fair amount of the initial coarse sediment load (Schueler et al., 1991). Sediment forebays are particularly useful for infiltration structures and sand filters, as they inhibit the more rapid clogging failures. Driscoll (1989) showed the effectiveness of using even a small forebay in sediment removal prior to entering a secondary control device. Using a probabilistic model, National Urban Runoff Program particle size/settling velocity mass percentile groupings, and rainfall statistics typical of the eastern U.S., the performance of a forebay one foot deep with a surface area of 43.5 square feet was evaluated. The contributing watershed area was one acre of completely impervious material. The predicted results are presented in Table 6.3. Notice that the forebay's performance is best during dynamic conditions. This is the desired result for a forebay. Also, the forebay removes an estimated 25% to 30% of all incoming TSS and approximately 80% of the largest incoming fraction. The performance estimate also assumes that a regular maintenance program removes accumulated sediment from the forebay.

Table 6.3
 Estimated Performance of a Sediment Forebay
 (from Driscoll, 1989)

Rainfall-Runoff Event Statistics					
	<u>Mean</u>	<u>COV</u>			
Volume (inches)	0.40	1.50			
Intensity (in/hr)	0.07	1.30			
Duration (hours)	6.00	1.10			
Interval (hours)	90.00	1.00			
Forebay Performance Estimates					
Size Fraction	Settling Velocity (ft/hr), Vs	Effective Vol. Ratio, VE/VR	Dynamic Removal %	Quiescent Removal %	Combined Removal %
1	0.03	0.01	1.4	0.4	1.0
2	0.30	0.02	5.0	1.2	6.1
3	1.50	0.03	12.5	2.2	14.5
4	7.00	0.03	32.5	2.4	34.2
5	65.00	0.03	80.6	2.4	81.0

6.8.3 GAC Filters

The adsorptive properties of granular activated carbon (GAC) are often used to capture organic compounds in industrial air and wastewater streams. In Florida, concern over the trihalomethane-forming potential (THMFP) of the organic constituents associated with highway runoff was increasing in areas where runoff was discharged directly to underground drainage wells (Wanielista et al., 1991). From 1905 until 1970, about 400 drainage wells were constructed in Florida in an attempt to reduce some runoff flooding problems. The practice was halted in 1970 amidst increasing suspicion of groundwater contamination.

A detention pond (3.2-acre surface area) that receives runoff from an Interstate highway and a commercial area (130-acre contributing watershed area) discharge into a 200-foot deep drainage well in an aquifer that is an underground source of drinking water

(USDW). The well was retrofitted with a GAC filter bed prior to the drainage well discharge. Measurements of the THMFP of the water before and after carbon treatment showed a significant amount of treatment. Approximately 6.3 milligrams of TOC was adsorbed per gram of activated carbon.

However, the GAC treatment was expensive. The annual cost to treat the water for THMFP precursors was calculated as \$316,000, or \$4.39/1000 gallons treated after detention and before well injection. Due to the rapid breakthrough experienced in the GAC beds, replacement of the carbon would be required after every one-inch storm event. Regeneration of the used carbon was estimated to be more expensive than the purchase of new carbon. The recommended use for the spent carbon was as a replacement for sand in concrete.

A separate problem encountered involved the rapid growth of bacteria in the GAC bed. The bacteria were associated with iron and manganese, which was present in high concentrations in the groundwater below the pond's underdrain system leading to the carbon bed. The bacteria formed layers in the pipe and the bed which sloughed off, partially clogging the bed inlet pipe and the underdrains. The problem was alleviated by surface-draining the pond, which eliminated the groundwater intrusion.

Although the GAC filter performed well in reducing the THMFP of the runoff, it was considered a cost-prohibitive procedure for this application. The study recommends applying the pond water as irrigation to the highway median and shoulder vegetation as a more cost effective measure for reducing THMFP in the USDW.

6.9 Combined Systems

Combined systems link the use of the previously mentioned control devices for enhanced and more uniform overall pollutant removal performance. In fact, a combination of runoff control measures is recommended whenever possible (Burch et al., 1985a). Combinations may increase the ability to effectively filter suspended solids or may be useful in reducing the site limitations for a single control measure. Vegetative controls are the only control structures which treat the runoff as it is conveyed; therefore,

these systems are recommended wherever possible as collection and conveyance links between treatment systems (Burch et al., 1985a).

When combining treatment systems two restrictions exist. First, infiltration devices should be the last structures in the treatment train since these systems are adversely affected by high sediment loads. Preceding structures should remove as much of the suspended sediment as possible to increase the effectiveness and longevity of the infiltration devices. Second, wetlands should not be used in conjunction with infiltration practices. Wetlands have the potential to discharge large sediment loads and decaying matter which can clog infiltration devices. Wetlands are best positioned in the middle of treatment trains. They should discharge to ponds or vegetated control structures.

One design combination involves ponds. Schueler et al. (1991) describe multiple pond systems (MPSs) as combinations of wet ponds, extended detention ponds, and wetlands in series. No one MPS design exists; the flexibility of the design allows the designer to minimize negative impacts associated with one system and maximize site-specific conditions. The redundancy of expected pollutant removal efficiencies increases the overall reliability and performance of the system. Many MPSs have demonstrated increased pollutant removals over single treatment systems. Different designs utilize longer flow paths, longer retention times, and more quiescent settling conditions to achieve the noted improved performance and reliability. Longevity is expected to be at least as long as for single ponds or wetlands. However, MPS designs may have longer life spans, since one part of the design may protect the long-term performance of another. Due to their complexity, costs associated with MPS designs are usually higher than regular ponds and wetlands. Maintenance is comparable to the single systems. In some cases, the MPS maintenance burden may actually be less due to the design.

Gain and Miller (1989) evaluated an MPS system that is a wet pond-wetlands design. The evaluation focused primarily on the removal efficiency of dissolved pollutants, particularly phosphorus, zinc, and lead. The wet pond has an approximate 0.2-inch runoff “live” storage space. The wetlands receive water from a spillway at the end of the pond and drain into a drainage channel. During a 22-month period, 22 storm events were monitored. Total runoff ranged between 0.10 inches to 0.63 inches, and

intensity ranged from 0.037 in/hr to 0.972 in/hr. The durations of most storms were about 5 hours, three were greater than 5 hours, and the maximum duration was around 11 hours.

A tracer dye study in the pond revealed that once the pond neared its maximum live storage capacity, the water began to short-circuit through the center of the pond in about 5 to 15 minutes, failing to displace or mix with any of the water in dead storage. If the entering runoff was significantly warmer than the water already in the pond, thermal stratification sometimes caused the runoff to float across the pond's surface.

The entire system was relatively ineffective at treating dissolved chlorides. No net removal of these pollutants was observed. Removal of total dissolved solids (TDS) was less in the pond than in the wetlands. Sediments in the pond bottom were thought to have dissolved into the dead storage space and were discharge to the wetlands. Also, since the pond has limited biological activity, less TDS materials are used through biological uptake. The TDS removal in wetlands is slightly better. The greater biological activity and the larger amount of organic matter on the pond bottom available for adsorption probably account for the increase. In general, however, overall TDS treatment by the system is poor.

Dissolved phosphorus concentrations are much greater in the wetlands than in the pond. The biological activity in the wetland causes the wetland to cycle phosphorus at a faster rate than the pond. The pond shows higher retention rates of total phosphorus. One reason provided is that the lessened pond biological activity corresponds to limited biological phosphorus assimilation. Also, studies have indicated that iron and aluminum presence may increase the retention of phosphorus. Under anaerobic conditions, dissolved iron and phosphorus in the pond sediments may diffuse upward into the aerobic zone of the pond, where the two metals combine with the phosphorus and form insoluble solids that settle back to the pond bottom. Dissolved oxygen levels of nearly zero at the bottom of the pond seem to support this explanation of increased phosphorus retention.

Virtually all of the lead is removed in the pond. Some of the zinc stays in the pond, but the majority is discharged into the wetlands. Since most of the lead and zinc entering the pond is in the suspended form, both metals initially settle to the pond bottom. However, zinc is fairly soluble under anaerobic conditions, while lead solubility remains

low. Zinc leaches from the pond bottom into the water and moves as dissolved zinc to the wetlands. Biological activity in the wetlands takes up some of the zinc. The remaining zinc, now under aerobic conditions, precipitates as zinc oxide.

Wulliman et al. (1989) described the use of a wet pond, followed by a series of infiltration/wetland areas. The design was developed to achieve an overall total phosphorus removal of 50%. Based on predictive modeling for the design, the most conservative estimated phosphorus removal is 52%; the most optimistic removal is 87%.

In California, a system draining a 39.5-acre auto auction site uses an oil and grit chamber to treat runoff from the site. Oil-adsorbing pillows floating on top of the chamber collect the oil and grease in the runoff. Water from the chamber is drained through an 1100-foot long combination grassed swale/infiltration ditch. No estimation of treatment efficiencies or maintenance activities is provided.

Holler (1990) evaluated a combined extended-detention/filtration system for total phosphorus and total orthophosphorus removal efficiency. The general design of the facility is shown in Figure 6.9. The pond is 200 ft x 400 ft, and designed for a maximum 3-foot storage depth. The storage capacity is for the first 0.5 inches of runoff (1.46 acre-feet) from the 75-acre urban/commercial contributing watershed. Excess runoff overflows the emergency spillway into the drainage channel. Filtration berms, each 100 feet long, are located at one end of the pond and slope slightly to one of two concrete drop boxes. Five filter berms extend radially from each drop box. A filter berm cross section is shown in Figure 6.10. The filtration media is a combination of limestone, sand, and native fill. The 6-inch PVC pipe underdrains connect to the drop box. The drop box tops are screened at 0.75 feet below the emergency spillway elevation to allow for berm overflow discharge. The intended extended-detention time is 48 hours.

Six storm events were monitored during a 1-year period. The basin water level receded much more slowly than the design values. Head losses of about 0.11 ft/day were typical. Apparently, the design lacks sufficient head to effectively operate the system. Severe reductions in the designed filter berm surface loadings also occurred. This probably happened because of the rapid growth of vegetation on top of the berms, and because the media became clogged with fines.

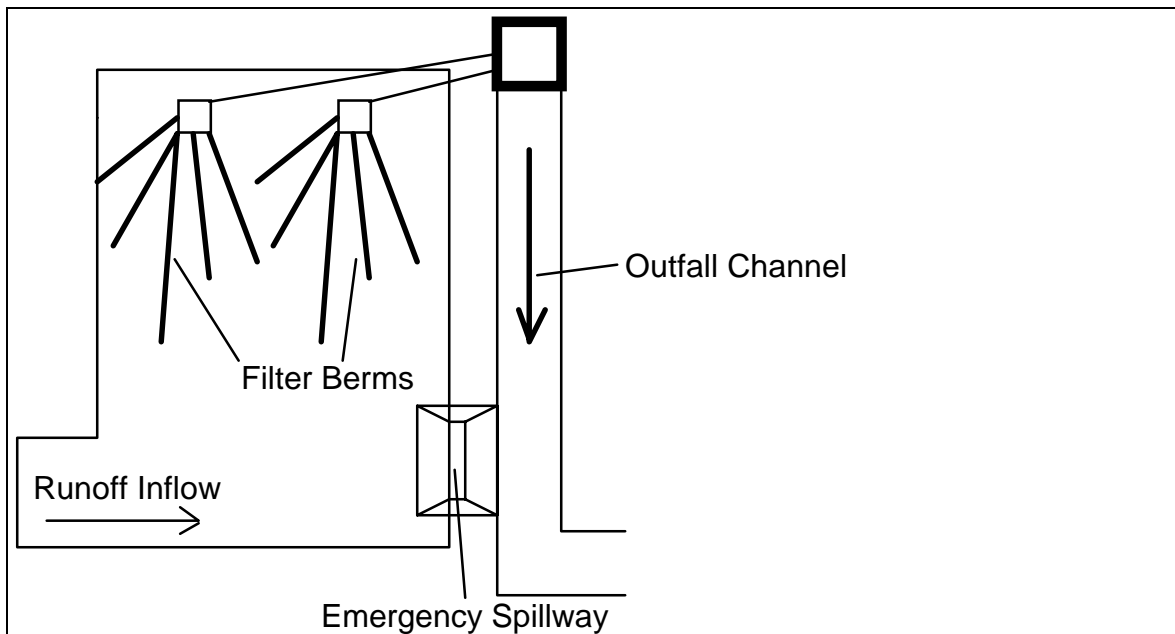

Figure 6.9 Site Layout of the Combination Detention/Filtration Pond
(Modified from Holler, 1990)

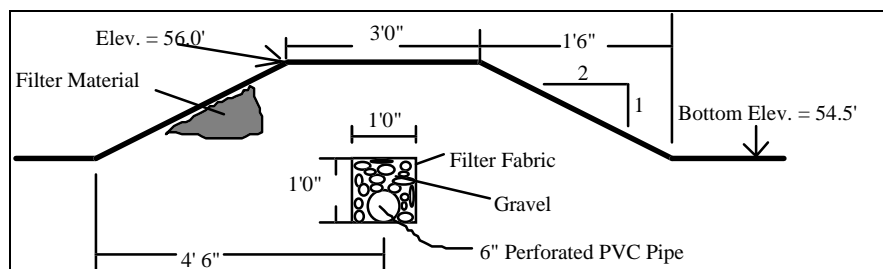

Figure 6.10 Cross Section of Filter Berm
(Modified from Holler, 1990)

Statistical analysis of the data showed significant treatment for both total phosphorus and total orthophosphorus in the extended-detention pond. The average removal for both was 77%. Statistical analysis of the measured removals at the filter berms showed no statistical significance between pre- and post-filter berm concentrations. Therefore, the filter berms apparently offer no additional treatment for total phosphorus or total orthophosphorus. The treatment measured for each component and for the total system is summarized in Table 6.4. The author hypothesizes that the vast improvement

Table 6.4
 Detention Pond/Filtration Berm Phosphorus Treatment Potential
 (from Holler, 1990)

Event No.	Treatment					
	Wet Detention		Filtration		Overall	
	o-PO ₄ -P	T-PO ₄ -P	o-PO ₄ -P	T-PO ₄ -P	o-PO ₄ -P	T-PO ₄ -P
1	83	91	-321	-86	29	83
2	77	80	-250	8	19	82
3	76	52	-92	60	54	81
4	78	84	26	37	84	90
5	81	82	50	38	91	89
6	69	71	42	38	82	82
$\bar{x} \pm s$	77 ± 4	77 ± 13	-91 ± 147	16 ± 48	60 ± 28	85 ± 4

* All values in percent

shown for filtration berm treatment of orthophosphorus during storms 4 through 6 may indicate a filter ripening process.

6.10 Comparative Studies

Several comparative analyses of the relative effectiveness of highway runoff control structures are in the literature. Studies have documented the differences between the performances of various control structures. The comparisons are either estimated or measured. The influence of different types of structures on groundwater has also been evaluated. Studies and surveys of relative maintenance requirements and practices are also available.

6.10.1 Predicted Performance

Maristany (1989) used a predictive model from the EPA, specific storm data, and structural dimension data to compare TSS removal efficiencies of wet ponds and infiltration basins. The ponds evaluated are in Florida and have contributing watershed areas ranging from 128 to 23,393 acres. The percent imperviousness of the watershed ranges from 9% to 54%. A graphical comparison of some of the results is presented in Figure 6.11. According to the estimates, at percolation rates between 0.1 in/hr and 0.5 in/hr, TSS removal efficiencies are better for wet ponds. The decrease in the infiltration

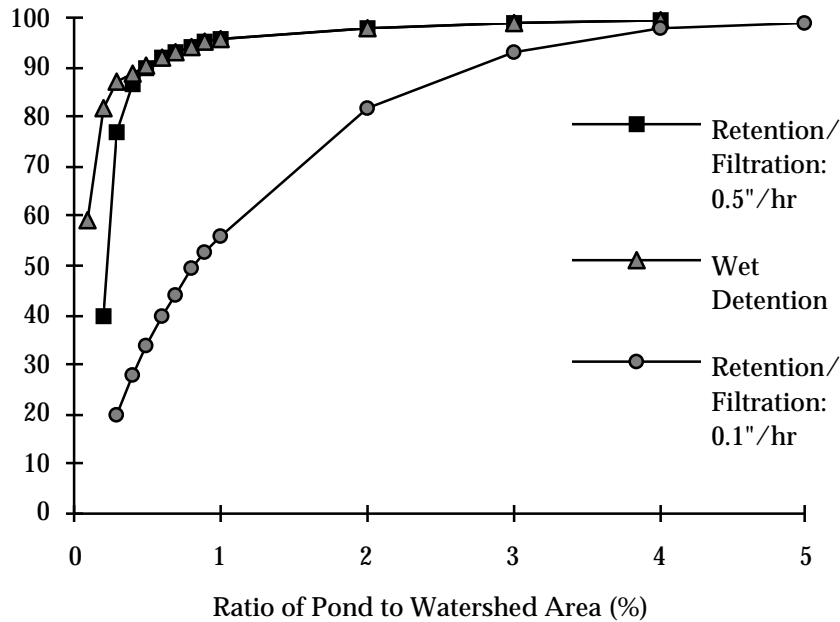

Figure 6.11 Comparison of Treatment Efficiencies for TSS of Wet Ponds and Retention/Filtration Basins (Modified from Maristany, 1989)

basin's performance shown for percolation rates of 0.1 in/hr indicates the infiltration basin's sensitivity to clogging and decreased soil permeabilities.

Driscoll et al. (1986) used U.S. Weather Service data along with watershed area information and a probabilistic analysis procedure to develop a computer code that will estimate long-term pollutant removal for various runoff control structures subjected to different operating conditions. The predicted results match actual measured performance data quite nicely in most cases. The authors point out that the program is a useful tool for optimizing a structure's design parameters.

6.10.2 Field Evaluations

Personnel of the City of Austin, Texas, (1990) performed evaluations of six runoff water quality control structures including one wet pond, two detention/filtration basins, and three sand filters. The two detention/filtration facilities were off-line systems, designed to treat the first 0.5 inch of runoff. The other four structures were on-line

systems. Average drawdown and detention times were calculated for the structures. Drawdown time is the time required for the total outflow to pass through the structure (the time range of the outflow hydrograph). The detention time is the volume of inflow divided by the outflow discharge. Since the discharge rate is not constant, the detention time was estimated as the time distance between inflow and outflow hydrograph centroids for a structure. For the 0.5 inch runoff events, average drawdown times ranged from 20 to 26 hours, and average detention times were from 4 to 6 hours. The City of Austin Drainage Criteria Manual (1991a) recommends drawdown times of 40 hours or less.

The measured ranges of removal efficiencies for the structures are presented in Table 6.5. The study notes that detention times greater than 4 hours may be necessary to increase the removal efficiencies of wet ponds. An increased dry pond detention time also increases the removal efficiency. Even so, with a relatively high detention time of about 6 hours, the removals observed for dry ponds were less than those associated with the filtration basins and the wet pond. Effective detention time and drawdown time for the filtration basins were determined to be 6 and 25 hours, respectively.

Table 6.5
Removal Efficiencies (%) Measured at City of Austin Facilities
(Modified from City of Austin, 1990)

System	TSS	BOD	COD	TOC	NO₂+NO₃	TN	TPO₄	Metals
Filtration	70-87%	15-51%	34-67%	44-61%	-82 to -26%	18-32%	3- 61%	19-86%
Wet Pond	46%	30%	31%	-9%	36%	29%	37%	41-72%
Dry Ponds	16%	23%	8%	18%	43%	22%	3%	-64-19%
Retention/ Filtration	86%	59%	82%	87%	-38%	47%	65%	71-84%

The filtration basins used a 12-inch to 18-inch layer of fine sand (0.02-inch to 0.04-inch diameter), and a layer of 0.5-inch to 2-inch gravel surrounding the underdrains. Some filtration basins had geotextile fabric placed over the sand layer to facilitate easier sand rejuvenation; the filter fabric was removed and replaced instead of the sand. Regular removal of the deposited sediment on top of the filters was required to maintain optimum performance and to prevent clogging. When this procedure was not performed,

the drawdown time reached several days. This reduced the overall efficiency of the infiltration basin since the design runoff of the next storm could not be totally captured.

The off-line systems performed better than the on-line ones during concurrent rainfall-runoff events. The on-line systems were unable to capture all of the pollutants. Overflow also resuspended some of the previously deposited sediments and carried the solids out of the structure. In all cases, sediment traps and forebays upstream of the filtration basins assisted in maintaining a working filter.

Yu and Benelmouffok (1988) compared the removals of a wet pond and a level spreader/vegetated buffer strip system (LS/VBS). The pond has a surface area of 1.67 acres, average depth of 7.6 feet, and a contributing watershed of 137 acres adjacent to a highway and commercial area. The level spreader drains an 18-acre area near a highway and shopping center complex. Water flows into an infiltration trench/detention area then overflows downslope through a 150-foot-long vegetated buffer strip. Five rainfall-runoff events were monitored for the pond and three were monitored for the LS/VBS. The data in Table 6.6 show that a 70-foot-long strip is virtually as effective as a 150-foot long strip for removal of most of the measured pollutants. The measured average pollutant removals for both systems are presented in Table 6.7. Removal efficiencies for TSS and zinc are similar for both facilities, but the wet pond is better at removing nitrite-nitrate nitrogen, total phosphorus, and lead.

The Metropolitan Washington Council of Governments (MWWCOG) evaluated several existing control structures (MWWCOG, 1983). Removals were statistically calculated in three ways: by averaging the average removal for each storm, by determining the median load from all storms for both inlet and outlet and calculating the median removal efficiency, and by summing the entire total inflow loads and total outflow loads over time and calculating the long-term removal efficiency. The differences in total removal efficiencies for the three types of ponds evaluated are summarized in Figure 6.12. The dry detention ponds (1- to 2- hour detention time) are relatively ineffective compared to the extended-detention (about 8 hours) and the wet ponds. The increased particulate removal associated with increased detention times is

Table 6.6
Overall Pollutant Removal Efficiency (%), Effect of Filter Strip Length
(from Yu and Benelmouffok, 1988)

Pollutant	Length of Filter Strip, (ft)			
	20	40	70	150
Suspended Solids (TSS)	28	40	70	71
NO ₃ +NO ₂	2	6	11	10
Total Phosphorus (TP)	23	14	28	38
Pb	2	18	20	25
Zn	18	24	51	51

Table 6.7
Overall Removal Efficiency of Two Systems
(Modified from Yu and Benelmouffok, 1988)

Pollutant	Wet Pond	LS/VBS (Full Length)
Suspended Solids (TSS)	77	71
Total Phosphorus (TP)	70	38
Nitrite-Nitrate	75	10
Lead	57	25
Zinc	50	51

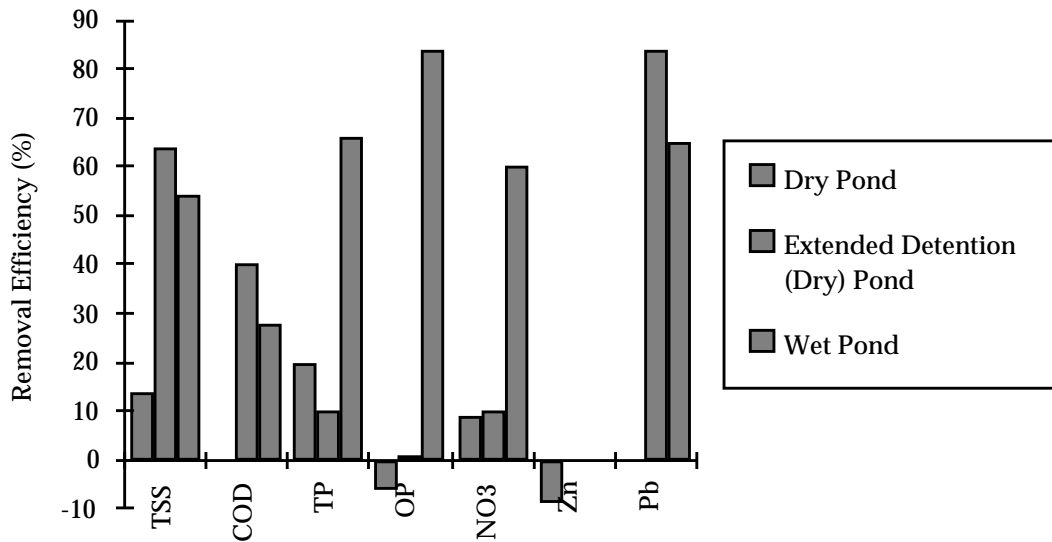

Figure 6.12 Pollutant Removal Efficiencies Associated with Different Pond Structures
(Modified from MWCOG, 1983)

evident when comparing the dry pond with the extended detention pond. Nutrient removals for these two types of ponds are lower than those of the wet pond, since inadequate time is available for biological assimilation and flocculation/sedimentation of the finer particulates associated with the nutrients to occur.

The data presented in Figure 6.13 clearly show the influence of larger storms on particulate removal as opposed to soluble nutrient removal. Since the larger storms are associated with increased particulate loads, the total removal efficiency calculation shows the increase in particulates associated with the larger storm events. Since an increase in nutrient load generally is not associated with an increased storm size, the three methods of removal efficiency calculation show similar values for the nutrient removal efficiencies.

Swales evaluated did not display appreciable pollutant removal results. A careful analysis of the swale sites used indicated four possible reasons. First, all of the swale sites monitored had silt soils beneath them. Second, measured contact times for runoff in

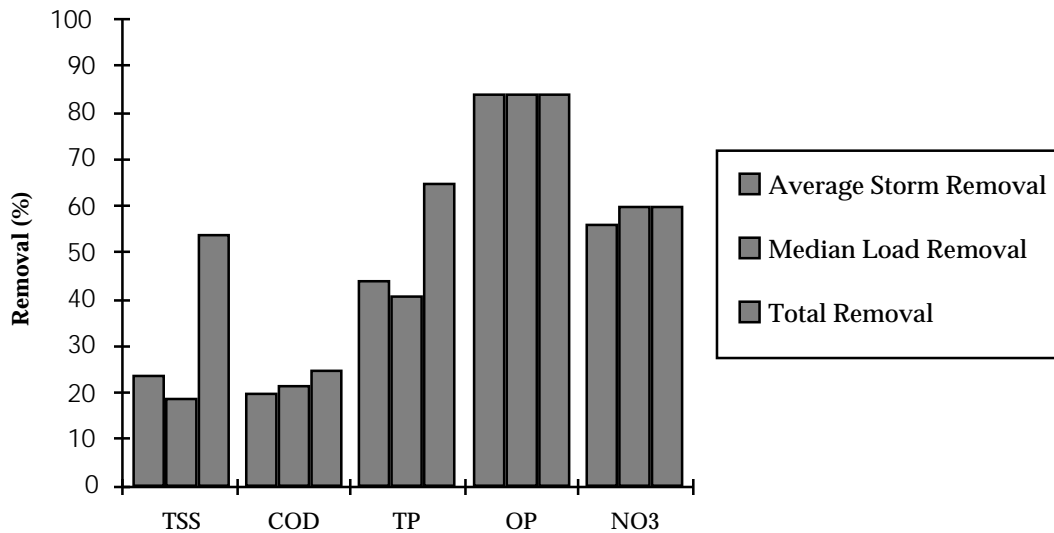

Figure 6.13 Comparison of Independent Methods Used to Calculate Wet Pond Removal Efficiencies (Modified from MWCOG, 1983)

the swale were from five to ten minutes, while the underlying silt loams required much longer times for percolation. Third, the swale slopes were from 4% to 6%. Often, the steep slopes caused an increase in the downstream water velocity, which in turn matted the grass, and conditions in the swale approached those of open flow. Finally, grass in the swales may have been mowed too frequently to effectively lower the swale water velocity.

The MWCOG cite settling studies that show that a detention time of 6 to 12 hours in ponds removes approximately 67% of the theoretical upper limit for TSS. The differences associated with 6-hour and 48-hour settling times measured in the settling column tests are presented in Figure 6.14. Since settling times greater than 12 hours only achieve incremental increases in removal rates, and the cost of additional storage space in a pond is a relative constant, the authors point out that designing for long detention times should be closely scrutinized. However, the authors recommend design retention times of 24 to 48 hours for infiltration structures since these devices normally have smaller storage space and throughput.

6.10.3 Maintenance Considerations

As previously mentioned, maintenance practices affect the performance and longevity of control devices designed to mitigate highway runoff. The amount and type of maintenance have an important bearing on which control systems are appropriate for a given application. Many authors and agencies have published specific maintenance guidelines for runoff controls. These recommendations often are specific to a certain area of the United States. The State of Maryland, Washington Department of Transportation, City of Austin, Texas, and the MWCOG have published extensive manuals which provide general maintenance recommendations as well as specific criteria particular to the respective geographic region. However, some authors have recommended general maintenance efforts not previously identified in this review that are not region-specific.

Pazwash (1991) recommends trash racks for the outlets of all ponds. These trash retainers should be cleaned out at least once in the spring and once in the fall. Detention

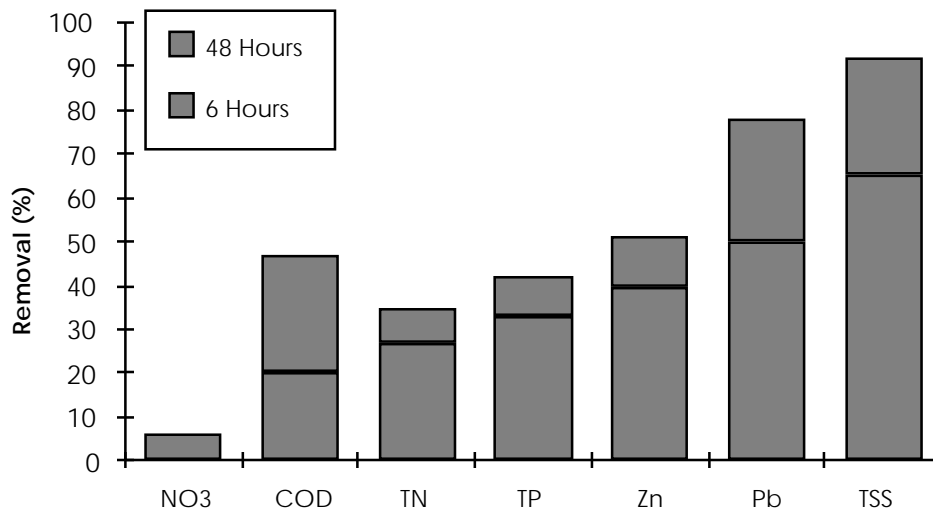

Figure 6.14 Observed Removal Rates in Experimental Settling Column Studies After 6 Hours and 48 Hours (Modified from MWCOCG, 1983)

ponds should have a concrete or rip-rap-lined low-flow channel constructed through the basin bottom. The channel prevents water from ponding and prevents a soggy basin bottom from forming between storms. This allows for ease of mowing the basin and prevents wetland plant establishment. Pazwash suggests that swales be irrigated during times of low moisture content to ensure the survival of vegetation.

Roenigk et al. (1992) conducted an extensive maintenance survey of over 800 stormwater control structures in four North Carolina cities. The structures surveyed include conveyance structures (e.g., culverts, inlet devices, channels, etc.), detention ponds, wet ponds, and infiltration trenches and basins. Although the survey focused on the maintenance efforts required to meet a structure's flood control design, the survey did offer some insight into the level of maintenance needed to provide water quality improvement.

The conditions of the facilities were rated as good, adequate, inadequate, or dangerous with respect to various maintenance activities required at a given type of structure. Typically, fewer than 5% of the conveyance structures were rated as inadequate or dangerous due to maintenance activities, whereas ponds and infiltration trenches and

basins had the worst ratings. Since the survey only evaluated the flood control capability of a structure and did not evaluate water quality, a higher maintenance failure rate may actually exist for these structures with respect to water quality. The report suggests that as the concern over runoff water quality increases, the level of required maintenance will increase and overall maintenance ratings may decline.

In a phone survey of city stormwater officials in all North Carolina cities with populations in excess of 5,000 individuals, respondents were asked to cite the runoff control structure maintenance activities which were performed on a regular basis. Mowing was the most regularly performed task (58%). Inlet cleaning was the next most frequently conducted activity (56%) followed by facility inspections (35%). Regular sediment removal at detention facilities was the least frequently cited activity (8%).

Of the cities surveyed which had retention/detention facilities, less than 50% had conducted sediment removal. Facilities which had undergone sediment removal averaged 10 years of use prior to sediment removal. Most removals were performed due to the observed reduced effectiveness of the facility rather than as a scheduled maintenance. Although most experts recommend a scheduled preventive maintenance approach, most communities surveyed used a reactive maintenance approach. The survey found no apparent cost differences between the two.

Four localities had their structures field-surveyed. This survey included a total of 46 retention/detention facilities. The retention/detention facilities had the most problems attributed to maintenance practices when compared to the culverts, lined channels, and vegetated channels. The maintenance requirements of the retention/detention facilities were greater, but were overlooked most often. The ponds and basins were cited as dumping grounds in 3 of the 4 cities. The ponds also were the leaders in the category of amount of debris and trash collected in the structure. In 33% of the facilities surveyed, embankments were too steep for mowers. Clogging failures and sediment accumulations were most apparent at these facilities as well. Algal blooms, odors, and mosquito problems were rare at these structures.

Finally, a survey of 25 experts in stormwater management was conducted. All of the panelists agreed that inspections, mowing, and sediment removal were important to

maintaining a facility, but they failed to agree on the recommended frequency of such activities. Few of them believed that annual sediment removal was required. All panelists agreed that the annual maintenance intensities (person-weeks per year and annual equipment/material expenses) were greatest for the ponds, with costs for the infiltration basin slightly less.

6.11 Design Aids

Several design manuals for runoff control structures are currently available. Most of these provide screening criteria for applicability of the structures to differing site conditions. Additionally, some provide methods for sizing the structures based on rainfall/runoff relationships.

Stahre and Urbonas (1990) provide numerous design examples for conventional basins and ponds. Although their text is primarily aimed at designing for flood control, they provide valuable insight on using rainfall/runoff relationships in a conservative manner so as to increase the performance and longevity of runoff control structures. This approach is equally applicable to the sizing of runoff control structures for pollution abatement.

The City of Austin, Texas, provides extensive design criteria for ponds, sand filters, and combined systems in its Drainage Criteria Manual (1991a) and its Environmental Criteria Manual (1991b). These two references provide designs which are meant to facilitate compliance with the city's strict watershed ordinances and provide protection over the Edwards Aquifer recharge zone.

For highway runoff, most design references specify vegetated controls as the preferred choice, followed by wet ponds or extended detention basins as the next best choice (Horner, 1985a,b,c; Burch et al., 1985a). Vegetated controls are recommended first primarily because of their wide adaptability, low cost and minimal maintenance requirements and not solely because of their pollutant removal capability. Wet ponds are recommended when space limitation and/or site conditions are not conducive to vegetated controls. Infiltration practices, although offering excellent treatment potential, are

recommended as the third choice based on their site-specific requirements and because of their increased likelihood of failure if not properly maintained (Burch et al., 1985a).

However, the State of Maryland recommends infiltration as the method of choice for runoff treatment. The state's extensive manuals for the design and maintenance of such facilities presumably increases the structure's success rate in Maryland (Maryland Dept. of the Environment, (1984a).

The most comprehensive design reference was written by Schueler (1987). This manual provides a comprehensive guide for screening, designing, cost estimating, and estimating pollutant removal efficiencies for a wide variety of control methods. These controls include extended detention ponds, wet ponds, infiltration trenches and basins, porous pavements, oil/grit chambers, grassed swales, and vegetated buffer strips. Schueler (1987) states that a structure's attainable pollutant removal is governed by (1) the removal mechanisms used, (2) the fraction of the annual runoff volume actually treated, and (3) the nature of the pollutant itself. Of these three items, the designer has control over 1 and 2 but no control over item 3. A graphical comparison of various designs based on field studies, laboratory investigations, modeling predictions and other theoretical considerations is presented in Table 6.8. From the table, one can see the expected performance of different systems for the removal of specific pollutants.

Table 6.8
Comparative Pollutant Removal of Control Structure Designs
(from Schueler, 1987; Galli, 1990)

CONTROL METHOD:	TSS	Total P	Total N	O ₂ Demand	Metals	Bacteria	Overall Capability
EXTENDED DETENTION POND:							
DESIGN 1	◐	◐	◐	◐	◐	⊗	MODERATE
DESIGN 2	●	◐	◐	◐	◐	⊗	MODERATE
DESIGN 3	●	◐	◐	◐	◐	⊗	HIGH
WET POND:							
DESIGN 4	◐	◐	◐	◐	◐	⊗	MODERATE
DESIGN 5	◐	◐	◐	◐	◐	⊗	MODERATE
DESIGN 6	●	◐	◐	◐	◐	⊗	HIGH
INFILTRATION TRENCH:							
DESIGN 7	◐	◐	◐	◐	◐	◐	MODERATE
DESIGN 8	●	◐	◐	◐	◐	◐	HIGH
DESIGN 9	●	◐	◐	●	●	●	HIGH
INFILTRATION BASIN:							
DESIGN 7	◐	◐	◐	◐	◐	◐	MODERATE
DESIGN 8	●	◐	◐	◐	●	◐	HIGH
DESIGN 9	●	◐	◐	●	●	●	HIGH
VEGETATED FILTER STRIP:							
DESIGN 10	◐	◐	◐	◐	◐	⊗	LOW
DESIGN 11	●	◐	◐	◐	●	⊗	MODERATE
GRASSED SWALE:							
DESIGN 12	◐	◐	◐	◐	◐	⊗	LOW
DESIGN 13	◐	◐	◐	◐	◐	⊗	LOW
SAND FILTER:							
DESIGN 14	◐	◐	◐	◐	◐	◐	MODERATE
PEAT-SAND FILTER:							
DESIGN 15	●	◐	◐	●	◐	●	HIGH

Design 1: First-flush runoff volume (i.e., 0.5 inches runoff per impervious acre) detained for 6 - 12 hours

Design 2: Runoff volume produced by 1 inch rainfall detained 24 hours

Design 3: Same as Design 2, but with shallow marsh in bottom stage

Design 4: Permanent pool equal to 0.5 inch storage per impervious acre

Design 5: Permanent pool equal to $2.5 \times V_T$ (V_T = mean storm runoff)

Design 6: Permanent pool equal to $4.0 \times V_T$; approximately 2 weeks retention

Design 7: Facility exfiltrates first-flush: 0.5 inches runoff per impervious acre

Table 6.8 continued

- Design 8: Facility exfiltrates 1.0 inches runoff per impervious acre
- Design 9: Facility exfiltrates all runoff up to the 2 year design storm
- Design 10: 20 foot wide turf strip
- Design 11: 100 foot wide forested strip with level spreader
- Design 12: High slope swales with no check dams
- Design 13: Low gradient swales with check dams
- Design 14: 0.5 inches of runoff storage per watershed acre with pretreatment detention
- Design 15: 0.5 inches of storage and exfiltration per impervious acre

KEY: ○=0 to 20 % removal, ◐=0 to 20 % removal, ◑=20 to 40 % removal, ◒=40 to 60 % removal, ◓=60 to 80 % removal, ⊗=Insufficient Knowledge

7.0 PREDICTIVE MODELING OF HIGHWAY RUNOFF

According to Driscoll et al. (1990c), three approaches are appropriate for the prediction of pollutants in stormwater runoff from highways. These methods can be grouped into the following categories:

- Regression Equations—These provide a relatively simple approach and have been used in a number of earlier studies dealing with runoff from highways and from urban areas.
- Simulation Models—A number of deterministic simulation models are commonly used in the prediction of urban runoff quality.
- Statistical Techniques—This method was successfully applied to urban runoff in the EPA National Urban Runoff Program (U.S. EPA, 1983).

7.1 Regression Equations

Regression equations provide a fairly simple means for estimating highway runoff quantity and quality. Several studies have combined comprehensive data bases and regression analysis (Driscoll et al., 1990c). These include three FHWA studies done by Envirex (Kobriger et al., 1981), the University of Washington (Chui et al., 1982), and the California Department of Transportation (Racin et al., 1982) and a USGS study (Miller et al., 1978). Regression methods also have been used to predict stormwater quantity and quality in urban watersheds (Driver and Tasker, 1988).

Balades et al. (1984) identified six significant variables for use in a linear regression model of runoff loads in a study of French highways. These included rain duration, mean flowrate, peak mean intensity, rain volume, antecedent dry period, and total traffic during the dry period. Coefficients were calculated based on the assumption that the correlations between the pollutant loads and the explanatory variables were linear and multiparametric.

The Envirex equations estimate the total solids (total suspended solids plus total dissolved solids, TS) load in runoff from individual storms and have two major components: accumulation of the TS, followed by washoff. Accumulation is modeled as a linear function of antecedent dry period and traffic volume, and washoff is expressed as an exponential function of the runoff rate. The loads of 16 other constituents are predicted by linear regression from TS (Kobriger et al., 1981b).

The Washington State model was developed on the basis of results from composite sampling of about 500 storms at nine locations. One component of the model is an expression for TSS load in relation to traffic, runoff coefficient, and surrounding land use. Other pollutants are computed as a fraction of the suspended solids load. The fraction may be taken as constants at any Washington State location for some pollutants or as linear functions of traffic for other pollutants. Chui et al. (1982) reported that the model was capable of predicting loadings over a time span encompassing a number of storms, but had little precision when applied to individual storms.

The California and USGS studies used multiple linear regression to predict pollutant loads using different independent variables such as average daily traffic, antecedent dry days, runoff volume, and storm duration (Driscoll et al., 1990c).

Miracle (1986) evaluated the accuracy of these models using measured rainfall, runoff, and water quality data from a highway site in Broward County, Florida. Predicted loads were then estimated for each method. These are the same data used by Miller et al. (1978) to develop regression equations and therefore bias the results in their favor. Results from this comparison are summarized in Table 7.1.

The USGS South Florida regression equations generally gave the best results when compared to actual data. This was to be expected since the storm events selected for comparison were from the same data base used to derive those equations. The California method also gave fairly good results for the average concentration; however, predictions for individual storms were not nearly as accurate. Both of these methods used pure multiple regression analysis with no assumption as to functional form other than linear or log-linear. Conversely, the other studies used a combination of regression methods. For example, Envirex also used linear buildup and exponential washoff

equations while Washington State modeled TSS, loads which were then regressed against other constituents (Driscoll et al., 1990c).

Table 7.1
Mean Percent Difference for Measured vs. Predicted Pollutant Loads, Broward County, Florida, Highway Site (modified from Driscoll et al., 1990c).

Constituent	USGS (S. FL.)	Envirex	Wash. St. (W. Wa.)	Wash. St. (E. Wa.)	California
Total Solids	-27	-69	-	-	-
Suspended Solids	-	100	16	-243	-18
Total Filt. Residue	-	-	-	-	77
TKN	-	-320	97	94	-6
NO ₃ -NO ₂	-	-	94	73	-
Total N	-19	-71	-	-	-
BOD	-	-678	-	-	-
COD	-80	-1108	93	72	60
TOC	-	-235	-	-	-
Total C	-39	-	-	-	-
Total P	-29	96	80	16	-
Lead	-43	64	96	90	74
Zinc	-86	-153	94	-131	23
Copper	-	-1824	86	43	-
Cadmium	-	-3402	-	-	-
Iron	-	100	-	-	-
Chromium	-	-359	-	-	-

7.2 Simulation Models

Numerous models have been developed to simulate stormwater runoff quantity and quality from urban and non-urban areas. These include the original EPA Storm Water Management Model (SWMM), as well as STORM (Storage, Treatment, Overflow, Runoff Model), HSPF (Hydrological Simulation Program - Fortran), and the FHWA Urban Highway Storm Drainage Model.

These models generally assume that a supply of constituents accumulates on the land surface during dry weather preceding a storm. This conceptual model is the result of a study in Chicago by the American Public Works Association (1969). In this study,

street surface accumulation of dust and dirt was measured by sweeping with brooms and vacuum cleaners. They found that the buildup of these constituents on road surfaces was a linear function of time. The rate of buildup also may be influenced by factors such as traffic flow, dry fallout, and street sweeping (James and Boregowda, 1985). Other studies investigating the buildup of contaminants include Sartor and Boyd (1972), Shaheen (1975), Pitt and Amy (1973), Pitt (1979), and Wada and Miura (1984).

During storm events this material is then washed off into the drainage system. The physics of the washoff may involve rainfall energy, as in some erosion calculations, or may be a function of bottom shear stress in the flow as in sediment transport theory. Commonly, washoff is modeled by an empirical equation based on the work of Sartor and Boyd (1972), who found that the rate of washoff of a constituent is proportional to the quantity remaining on the watershed.

Simulation models are the most demanding of site-specific data, including measured runoff quality data. However, the data are usually not available because data collection is expensive and difficult. Also, as discussed by Abbott et al. (1986a,b) and Loague and Freeze (1985), a primary barrier to successful application of physically based models is the scaling problem. Field measurements are made at the point or local scale, whereas the application in the model is at the larger scale of the grid used to represent the hydrologic processes.

The advantage of simulation models is not that they provide a better prediction of storm event loads, since they do not necessarily do so (Lindner-Lunsford and Ellis, 1987). Rather, the models provide a more physically realistic predictive mechanism which, when calibrated, may more easily be altered to examine the effects of changes and abatement practices. Also, simulation models provide a temporal and spatial distribution that is unavailable in simple regression techniques (Driscoll et al., 1990c). Detailed discussions of simulation models are provided by Huber and Heaney (1982), Kibler (1982), EPA (1983), Whipple et al. (1984), and Huber (1985).

SWMM, FHWA, STORM, and HSPF can all be utilized for highway sites. The buildup and washoff algorithms of the STORM and FHWA models are basically less flexible versions of the general routines available in SWMM. Therefore, SWMM might

be preferred for its many options, including rating curves, unless the specific hydrology of one of the other two models is desired. HSPF is almost as flexible as SWMM except for its exponential washoff, which is more limited. On the other hand, its solids washoff equations are probably more sophisticated than those in SWMM, being based on data from pervious areas (Driscoll et al., 1990c).

All four models have been used in urban areas, including highway surfaces, and a choice might be made on the basis of personal preference or familiarity; however, the ability to perform both continuous and single event simulation, plus the several modeling options available in SWMM and HSPF would probably place these two at the head of the list. Both models can be used for both planning and screening purposes, as well as for detailed design simulations. Their general parameter options also may make them easier to calibrate (Driscoll et al., 1990c).

SWMM permits simulation of a wide range of features of urban hydrology and water-quality processes. It deals with the movement of pollutants from the land surface of the modeled area to combined sewers or storm drainage outfalls. Hydrographs developed in the hydrologic portions are input to the water-quality part of the model. Output is in the form of pollutographs for each pollutant modeled. The hydrographs and the pollutographs are combined with the dry weather and infiltrated flow components to produce outflow graphs of water quality and quantity. SWMM predicts concentrations of suspended solids, nitrates, phosphates, and other pollutants in storm water runoff. Without calibration, the computed pollutographs should be considered to provide only relative comparisons between control approaches (DeVries and Hromadka, 1992).

HSPF allows an integrated simulation of land and soil contaminant runoff processes with in-stream hydraulic and sediment-chemical interactions. The program provides a time history of runoff rate, sediment load, and nutrient and pesticide concentrations, along with a time history of water quality and quantity at specific points in a watershed. HSPF simulates sand, clay, and silt sediments and a single organic chemical and transformation products of that chemical. Exchanges between benthic deposits and the overlying water column are also allowed. The program user must supply parameters for each of the various processes. More than 20 parameters are needed to

describe merely the hydrologic processes, some of which cannot be directly measured, such as the various soil moisture parameters (DeVries and Hromadka, 1992).

7.3 Statistical Techniques

The initial methodology was developed by Hydrosience (U.S. EPA, 1976) and later refined (Hydrosience, Inc., 1979) as a screening tool for estimates of stormwater quality loads and concentrations and their impact on receiving waters. The underlying idea is to derive the moments (e.g., mean and variance) of the stormwater runoff event mean concentrations and loads and then use these moments to derive the moments of the concentrations in the receiving water. Thus, the probability distribution is available for analysis instead of just the mean values that a regression-type analysis would produce (Driscoll et al., 1990c). Detailed reviews and comparisons of the methodology are given by Nix (1982), Goforth et al. (1983), and Shelley et al. (1987) .

The statistical method has been applied broadly as part of the NURP program and is well suited for estimating stormwater runoff quality due to its simplicity and availability of regional parameters (i.e., the statistics of rainfall may be described regionally) (Driscoll et al., 1990c). The NURP study found that event mean concentrations can be characterized by a lognormal distribution (EPA, 1983). This has a number of benefits in that:

- Concise summaries of highly variable data can be developed.
- Comparisons of results from different sites, events, etc., are convenient and are more easily understood.
- Statements can be made concerning frequency of occurrence; one can express how often values will exceed various magnitudes of interest.
- A more useful method of reporting data than the use of ranges is provided, one which is less subject to misinterpretation.
- A framework is provided for examining transferability of data in a quantitative manner.

Statistical models cannot simulate the interactions of flow and concentration nor the effect of abatement actions as well as simulation models can. For example, simulation models avoid the assumption that the coefficient of variation of the runoff and quality time series is the same as for the rainfall time series.

The statistical screening procedure developed for the NURP (EPA, 1983) program operates as follows:

- Downstream Concentrations. Stream concentrations of a pollutant are considered to result from the combination of upstream flow at background concentration and runoff flow at its concentration. Variations in stream concentrations below the runoff discharge result from variations in each of these inputs, the most significant source of variation being whether or not an event is occurring.
- Parameter Estimates. Estimates for runoff flows and concentrations are developed from information derived from the NURP monitoring programs. Information on stream flow can be obtained from analysis of local stream gage records. Upstream concentrations tend to be very site-specific; for this reason, the screening analysis calculated only the effect of runoff discharges.
- Statistical Calculations. From the statistical properties of the flows and concentrations, properties of the dilution ratio can be defined, and the statistical properties of the resulting instream concentrations are calculated directly. The frequency with which any particular target concentration is exceeded during wet weather can be calculated from the statistical properties of stream concentration, using formulas or scaled directly from a standard plot of cumulative probability distributions.
- Mean Recurrence Interval. The recurrence interval is defined as the reciprocal of probability. Because the basic calculation is based on storm events, this definition yields the overall average number of storms between specific event occurrences. Knowing the number of storms per year, one can convert to the time recurrence.

The statistical screening procedure was chosen by Woodward Clyde Consultants for the basis of a model to predict pollutant loads and impacts of highway runoff for the Federal Highway Administration (Driscoll et al., 1990c). Data collected at highway sites throughout the U.S. were used to evaluate the statistical properties of highway runoff flows and concentrations; regional values for precipitation and streamflow from standard monitoring programs were used to provide the other necessary input parameters.

Upstream concentrations tend to be very site-specific; for this reason, the screening analysis calculated only the effect of runoff discharges.

The user can select any of the 10 pollutants for which information on concentrations are included in the model. The authors of the program analyzed the results from 993 individual storm events at 31 highway runoff sites in 11 states (Driscoll et al., 1990d). The sites were divided into two categories, urban or rural, depending upon whether the average daily traffic exceeded 30,000 vehicles per day. The statistics of the runoff concentrations were then calculated for each category. The program initially selects the 50th percentile highway site for estimating the site median concentration of the runoff; however, the user is free to choose another percentile.

A target concentration is selected by the user for most of the pollutants to be analyzed. If one of the heavy metals is chosen for analysis, the user is prompted to enter a value for the total hardness for the stream, and the program computes the corresponding target concentration using the relationships developed by the EPA for acute toxicity.

This model is also able to simulate the effects of abatement practices by estimating the amount of solids removed. The abatement practices include grass channels, overland flow, wet ponds, and infiltration. The removal efficiencies of these controls are determined by the user's assignment of device size.

Several assumptions were made in the development of this model which limit its usefulness for certain applications. The model assumes independence of runoff volume and stream flow, of pollutant concentration and runoff volume, and that the statistics describing the runoff are the same as those for rainfall. The most serious problem is that the model assumes that the upstream pollutant concentration is zero, clearly not the case for many parameters such as COD. The predicted instream concentrations reflect only a dilution of the highway runoff and not the true downstream concentration.

A worksheet version of the model is contained in a report by Driscoll et al. (1990a), and a computer version is available from the National Technical Information Service (PB93-504579). Detailed descriptions of the methodology are available in Driscoll et al. (1990c) and Gaboury et al. (1987).

BIBLIOGRAPHY

Abbott, M.B., et al., 1986a, "An Introduction to the European Hydrological System – Systeme Hydrologique Europeen, 'SHE'- 1: History and Philosophy of a Physically-Based, Distributed Modelling System," Journal of Hydrology, Vol. 87, pp. 45-59.

Abbott, M.B., 1986b, "An Introduction to the European Hydrological System – Systeme Hydrologique Europeen, 'SHE'- 2: Structure of a Physically-Based, Distributed Modelling System," Journal of Hydrology, Vol. 87, pp. 61-77.

Adams, W.R., Jr., 1981, "Interstate Highways Versus Watershed Protection in New England," Journal of the American Water Works Association, Vol. 73, No. 7, pp. 346-349.

American Public Works Association, 1969, "Water Pollution Aspects of Urban Runoff," Federal Water Pollution Control Administration, Contract WP-20-15, Washington, DC.

Anderson, B.A., and Simons, D.B., 1984, "Soil Erosion Study of Exposed Highway Construction Slopes and Roadways," Transportation Research Record 948, pp. 40-46.

Armstrong, D.E., and Llena, R., 1992, Stormwater Infiltration: Potential for Pollutant Removal, Water Chemistry Program, University of Wisconsin-Madison, WI.

Armstrong, J.J., 1992, "Protocol for the Testing of Surficial Erosion Control Materials," MAT-92-07, Ontario Department of Transportation, 6 pp.

Armstrong, J.J., 1991, "Protocol for the Testing of Surficial Erosion Control Materials," MAT-91-11, Ontario Department of Transportation, 5 pp.

Armstrong, J.J., and Wall, G.F., 1991, "Quantitative Evaluation of the Effectiveness of Erosion Control Materials," Proceedings of Conference XXII, International Erosion Control Association, pp. 167-179, Orlando, Florida.

Asplund, R.L., Ferguson, J.F., and Mar, B.W., 1982, "Total Suspended Solids in Highway Runoff in Washington State," Journal of the Environmental Engineering Division of ASCE, Vol. 108., pp. 391-404.

Asplund, R.L., Ferguson, J.F., and Mar, B.W., 1980, Characterization of Highway Runoff in Washington State, Washington State Department of Transportation Report No. WA-RD-39.6.

Aye, R.C., 1979, Criteria and Requirements for Statewide Highway Runoff Monitoring Sites, Washington State Department of Transportation Report No. WA-RD-39.5.

Balades, J.D., Cathelain, M., Marchandise, P., Peybernard, J., and Pilloy, J.C., 1984, "Chronic Pollution of Intercity Motorway Runoff Waters," Water Science Technology, Vol. 17, No. 6/7, pp. 1165-1174.

Ball, D.J., Hamilton, R.S., and Harrison, R.M., 1991, "The Influence of Highway-Related Pollutants on Environmental Quality," in Highway Pollution, edited by Hamilton, R.S., and Harrison R.M., Studies in Environmental Science 44, Elsevier Science Publishing, New York.

Barton, B.A., 1977, "Short-Term Effects of Highway Construction on the Limnology of a Small Stream in Southern Ontario," Freshwater Biology, Vol. 7(2), pp. 99-108.

Barton, J.R., White, D.A., Winger, P.V., and Peters, E.J., 1972, "The Effects of Highway Construction on Fish Habitat in the Weber River, Near Henefer, Utah," in Ecological Impact of Water Resources Development--A Technical Session of the Symposium 'Water, Man and Nature': Bureau of Reclamation Report Rec-ERC-72-17, pp. 17-28.

Beaven, T.R., and McPherson, B.F., 1978, Quality of the Water in Borrow Ponds Near a Major Highway Interchange, Dade County, Florida, Oct.-Nov. 1977, USGS Open-File Report 78-1029.

Bell, J.H., and Wanielista, M.P., 1979, "Use of Overland Flow in Storm-Water Management on Interstate Highways," Fifty-Eighth Annual Meeting of the Transportation Research Board, Washington, DC., Transportation Research Record 736, pp. 13-21.

Bellinger, E.G., Jones, A.D., and Tinker, J., 1982, "The Character and Dispersal of Motorway Runoff Water," Water Pollution Control, Vol. 81, No. 3, pp. 372-390.

Berg, V.H., 1991, Water Quality Inlets (Oil/Grit Separators), Maryland Department of the Environment, Sediment and Stormwater Administration, Baltimore, MD.

Besha, J.A., McGrew, C.I., and McDuffey, V.C., 1983, Richmondville Stream Monitoring and Control System. Final Report, New York State Department of Transportation.

Birdsall, C.W., Grue, C.E., and Anderson, A., 1986, "Lead Concentrations in Bullfrog *Rana catesbeiana* and Green Frog *R. clamitans* Tadpoles Inhabiting Highway Drainages," Environmental Pollution (Series A), Vol. 40, No. 3, pp. 233-247.

Bourcier, D.R., Hinden, I., and Cook, J.C., 1980, "Titanium and Tungsten in Highway Runoff at Pullman, Washington," International Journal of Environmental Studies, Vol. 15, No. 2, pp. 145-149.

Bourcier, D.R., and Hinden, E., 1979, "Lead, Iron, Chromium and Zinc in Road Runoff at Pullman, Washington," Science of the Total Environment, Vol. 12, pp. 205-215.

Burch, C.W., Johnson, F., and Maestri, B., 1985a, Management Practices for Mitigation of Highway Runoff Pollution: Volume I, Guidelines, FHWA/RD-85-001, Versar Inc., Springfield, VA.

Burch, C.W., Johnson, F., and Maestri, B., 1985b, Management Practices for Mitigation of Highway Runoff Pollution: Volume II, Literature Review, FHWA/RD-85-002, Versar Inc., Springfield, VA.

Burton, T.M., Turner, R.R., and Harris, R.C., 1976, "The Impact Of Highway Construction on a North Florida Watershed," Wat. Resour. Bull., Vol. 12, pp. 529-538.

Butler, D., Thedchanamoorthy, S., and Payne, J.A., 1992, "Aspects of Surface Sediment Characteristics on an Urban Catchment in London," Water Science and Technology, Vol. 25, No. 8, pp. 13-19.

Carroll, R.G., Jr., Rodencal, J., and Theisen, M.S., 1991, "Evaluation of Turf Reinforcement Mats and Erosion Control and Revegetation Mats Under High Velocity Flows," Proceedings of Conference XXII, International Erosion Control Association, Orlando, Florida, pp. 133-145.

Chisholm, J.L., and Downs, S.C., 1978, Stress and Recovery of Aquatic Organisms as Related to Highway Construction along Turtle Creek, Boone County, West Virginia, USGS Water-Supply Paper 2055.

Christensen, E.R., and Guinn, V.P., 1979, "Zinc from Automobile Tires in Urban Runoff," ASCE Environmental Engineering Division, Vol. 105, No. EE1.

Chui, T.W.D., Mar, B.W., and Horner, R.R., 1982 "Pollutant Loading Model for Highway Runoff," Journal of the Environmental Engineering Division of ASCE, Vol. 108, pp. 1193-1210.

Chui, T.W.D., Mar, B.W., and Horner, R.R., 1981, Highway Runoff in Washington State: Model Validation and Statistical Analysis, Washington State Department of Transportation Report No. WA-RD-39.12.

City of Austin, 1991a, Drainage Criteria Manual, Department of Planning and Development, Austin, TX.

City of Austin, 1991b, Environmental Criteria Manual, Department of Planning and Development, Austin, TX.

City of Austin, 1990, Removal Efficiencies of Stormwater Control Structures, Environmental and Conservation Services Dept., Austin, TX.

Clark, D.L., Asplund, R. Ferguson, J., and Mar, B.W., 1981, "Composite Sampling of Highway Runoff," Journal of the Environmental Engineering, Vol. 107, pp 1067-1081.

Clark, D.L., and Mar, B.W., 1980, Composite Sampling of Highway Runoff: Year 2, Washington State Department of Transportation Report No. WA-RD-39.4.

Cline, L.D. Short, R.A., and Ward, J.V., 1982, "Influence of Highway Construction on the Macroinvertebrates and Epilithic Algae of a High Mountain Stream," Hydrobiologia Vol. 96, No. 2, pp. 149-159.

Cole, W.H., and Yonge, D.R., 1993, Sediment Basin Design Criteria, Washington State Department of Transportation Report No. WA-RD 336.1.

Colwill, D.M., Peters, C.J., and Perry, R., 1984, Water Quality of Motorway Runoff, Transport and Road Research Laboratory Supplementary Report 823.

Crabtree, A., Day, E., Garlo, A., and Stevens, G., 1992, Evaluation of Wetland Mitigation Measures, FHWA-RD-90-083, Federal Highway Administration, McClean, VA.

Cramer, G.H., II, and Hopkins, W.C., Jr., 1982, "Effects of Dredged Highway Construction on Water Quality in a Louisiana Wetland," Transportation Research Record, 896, pp. 47-50.

Crebbin, Cory, 1988, "Laboratory Evaluation of Geotextile Performance in Silt Fence Applications Using a Subsoil of Glacial Origin," Master's Report, University of Washington.

Dallaire, G., 1976, "Filter Fabrics: Bright Future in Road and Highway Construction," Civil Engineering-ASCE, Vol. 46, No. 5, pp. 61-65.

DeVries, J.H., and Hromadka, T.V., 1992, "Computer Models for Surface Water," in Handbook of Hydrology, Maidment, D.R., ed., McGraw-Hill, New York.

Dorman, M.E., Hartigan, J., Johnson, F., and Maestri, B., 1988, Retention, Detention and Overland Flow for Pollutant Removal from Highway Stormwater Runoff: Interim Guidelines for Management Measures, FHWA/RD-87/056, Versar Inc., Springfield, VA.

Downs, S.C., and Appel, D.H., 1986, "Progress Report on the Effects of Highway Construction on Suspended-Sediment Discharge in the Coal River and Trace Fork, West Virginia 1975-81," USGS Water-Resources Investigations Report 84-4275.

Driscoll, E.D., Shelley, P.E., and Strecker, E.W., 1990a, Pollutant Loadings and Impacts from Highway Stormwater Runoff, Vol. I: Design Procedure, Federal Highway Administration, Office of Research and Development Report No. FHWA-RD-88-006.

Driscoll, E.D., Shelley, P.E., and Strecker, E.W., 1990b, Pollutant Loadings and Impacts from Highway Stormwater Runoff, Vol. II: Users Guide for Interactive Computer Implementation of Design Procedure, Federal Highway Administration, Office of Research and Development Report No. FHWA-RD-88-007.

Driscoll, E.D., Shelley, P.E., and Strecker, E.W., 1990c, Pollutant Loadings and Impacts from Highway Stormwater Runoff, Vol. III: Analytical Investigation and Research Report, Federal Highway Administration, Office of Research and Development Report No. FHWA-RD-88-008.

Driscoll, E.D., Shelley, P.E., and Strecker, E.W., 1990d, Pollutant Loadings and Impacts from Highway Stormwater Runoff, Vol. IV: Research Report Data Appendix, Federal Highway Administration, Office of Research and Development Report No. FHWA-RD-88-009.

Driscoll, E.D., 1989, "Long Term Performance of Water Quality Ponds," Proceedings of an Engineering Foundation Conference on Current Practice and Design Criteria for Urban Quality Control, ASCE, New York, NY, pp. 145-163.

Driscoll, E.D., DiToro, D., Gaboury, D., and Shelley, P., 1986, Methodology for Analysis of Detention Basins for Control of Urban Runoff Quality, EPA 440/5-87-001, Woodward-Clyde Consultants, Walnut Creek, CA.

Driver, N.E., and Tasker, G.D., 1988, Techniques for Estimation of Storm-Runoff Loads, Volumes, and Selected Constituent Concentrations in Urban Watersheds in the United States, USGS Water-Supply Paper 2363.

Duck, R.W., 1985, "The Effect of Road Construction on Sediment Deposition in Loch Earn, Scotland," Earth Surf. Proc. Landforms 10, pp. 401-406

Dunlap, K., 1994, "SR 37 Highway Update," IKC Update No. 34, Indiana Karst Conservancy, Indianapolis, IN.

Dupuis, T.V., Kaster, J., and Bertram, P., 1985a, Effects of Highway Runoff on Receiving Waters - Vol. II Research Report, Federal Highway Administration, Office of Research and Development Report No. FHWA/RD-84/063.

Dupuis, T.V., Kobriger, N.P., Kreutzberger, W.K., and Trippi, V., 1985b, Effects of Highway Runoff on Receiving Waters - Vol. III Resource Document for Environmental Assessments, Federal Highway Administration, Office of Research and Development Report No. FHWA/RD-84/064.

Dupuis, T.V., and Kobriger, N., 1985c, Effects of Highway Runoff on Receiving Waters - Vol. IV: Procedural Guidelines for Environmental Assessments, Federal Highway Administration, Office of Research and Development Report No. FHWA/RD-84/065.

Dupuis, T.V., Kreutzberger, T., Kaster, J., and Harris, T., 1985d, Effects of Highway Runoff on Receiving Waters - Vol. V: Guidelines for Conducting Field Studies, Federal Highway Administration, Office of Research and Development Report No. FHWA/RD-84/066.

Dussart, G.B.J., 1984, "Effects of Motorway Runoff on the Ecology of Stream Algae," Water Pollution Control, Vol. 83, No. 3, pp. 409-415.

Ebert, D.J., and Filipek, S.P., 1988, "Response of Fish Communities to Habitat Alteration in a Small Ozark Stream," Proceedings of the Arkansas Academy of Science, Vol. 42, pp. 28-32.

Eckhardt, D.A.V., 1976, Sediment Discharge from an Area of Highway Construction, Applemans Run Basin, Columbia County, Pennsylvania, USGS Water-Resources Investigations 76-111.

Edwards, M., and Benjamin, M.M., 1989, "Adsorptive Filtration Using Coated Sand: A New Approach for Treatment of Metal-Bearing Wastes," Journal Water Pollution Control Federation, Vol. 61, No. 9, pp. 1523-1533.

Ellis, J.B., Revitt, D.M., Harrop, D.O., and Beckwith, P.R., 1987, "The Contribution of Highway Surfaces to Urban Stormwater Sediments and Metal Loadings," The Science of the Total Environment, Vol. 59, pp. 339-349.

Ellis, J.B., Harrop, D.O., and Revitt, D.M., 1986, "Hydrological Controls of Pollutant Removal from Highway Surfaces," Water Research, Vol. 20, No. 5, pp. 589-595.

Ellis, J.B., and Harrop, D.O., 1984, "Variations in Solids Loadings to Roadside Gully-pots," Science of the Total Environment, Vol. 33, pp. 203-211.

Embler, P.F., and Fletcher, M.O., 1983, Effects of Highway Construction on Stream Turbidity and Suspended Solids: A Case Study, FHWA/SC-81/3, Federal Highway Administration, Washington, DC.

Evans, K.M., Gill, R.A., and Robotham, P.W.J., 1990, "The Source, Composition and Flux of Polycyclic Aromatic Hydrocarbons in Sediments of the River Derwent, Derbyshire, U.K.," Water, Air, and Soil Pollution, Vol. 51, pp. 1-12.

Extence, C.A., 1978, "The Effects of Motorway Construction on an Urban Stream," Environmental Pollution, Vol. 17, pp. 245-252.

Fan, J., and Lovell, C.W., 1988, "Slope Steepness Factor for Predicting Erosion on Highway Slopes," Effects of Geosynthetics on Soil Properties and of Environment on Pavement Systems, Transportation Research Record 1188.

Gaboury, D.R., Driscoll, E.D., and Sartor, J.D., 1987, "Probabilistic Methodology for Estimating Water Quality Effects from Highway Stormwater Runoff," in Science of the Total Environment, Vol. 59, pp. 447-456.

Gain, W.S., and Miller, R.A., 1989, "Processes Affecting Retention of Water-Quality Constituents in a Detention Pond-Wetland System," in Water: Laws and Management, American Water Resources Association.

Galli, J., 1990, Peat-Sand Filters: A Proposed Stormwater Management Practice for Urbanized Areas, Department of Environmental Programs, Metropolitan Washington Council of Governments, Washington, DC.

Garcia, K.T., 1988, "Effect of Erosion-Control Structures on Sediment and Nutrient Transport, Edgewood Creek Drainage, Lake Tahoe Basin, Nevada, 1981-83," . USGS Water Resources Investigations Report 87-4072.

Garton, E.R., Jr., 1977, "The Effects of Highway Construction on the Hydrologic Environment at Bowden, West Virginia," In: Hydrologic Problems in Karst Regions, edited by Ronald R. Dilamarter and Sandor C. Csallany, Western Kentucky University, Bowling Green, KY.

Geiser, H., 1974, "Groundwater Protection in Highway Construction in the Catchment area of the City of Berne at Kiesen (Grundwasserschutz Beim Autobahn Im Fassungsgebiet Stadt Bern In Kiesen)," Gas Wasser Abwasser, Vol. 54, No. 9, pp. 385.

German, E.R., 1983, Water Quality of Lakes Faith, Hope, Charity, and Lucien, 1971-79, in an Area of Residential Development and Highway Construction at Maitland, Florida, USGS Water Resources Investigations 82-51.

Gervais, F.A., and Piercey, D.E., 1988, "Construction Through Delicate Ecosystems," Windsor Junction, Nova Scotia: Nova Scotia Department of Transportation and Communications Publication.

Gish, C.D., and Christensen, R.E., 1973, "Cadmium, Nickel, Lead and Zinc in Earthworms from Roadside Soil," Environmental Science and Technology, Vol. 7, No. 11, pp. 1060-1062.

Gjessing, E., Lygren, E., Andersen, S., Berglind, L., Carlberg, G., Efrainsen, H., Kallquist, T., and Martinsen, K., 1984a, "Acute Toxicity and Chemical Characteristics of

Moderately Polluted Runoff from Highways,” The Science of the Total Environment, Vol. 33, pp. 225-232.

Gjessing, E., Lygren, E., Berglind, L., Gulbrandsen, T., and Skaane, R., 1984b “Effect of Highway Runoff on Lake Water Quality,” The Science of the Total Environment, Vol. 33, pp. 245-257.

Glick, R.H., Wolfe, M.L., and Thurow, T.L., 1993, Effectiveness of Native Species Buffer Zones for Nonstructural Treatment of Urban Runoff, Technical Report No. 156, Texas Water Resources Institute, Texas A&M University.

Goforth, G.F., Heaney, J.P., and Huber, W.C., 1983, “Comparison of Basin Performance Modeling Techniques,” Journal of Environmental Engineering 109, No. 5, pp. 1082-1098.

Goldman, S.J., Jackson, K., and Bursztynsky, T.A., 1986, Erosion and Sediment Control Handbook, McGraw Hill Book Company, New York.

Gordon, J.R., 1975, “Interdisciplinary Team Approach to Mitigating Adverse Environmental Impacts of Highway Construction,” Transportation Research Record, Vol. 551, pp. 1-11.

Gupta, M.K., Agnew, R.W., and Kobriger, N.P., 1981a, Constituents of Highway Runoff Vol. I: State of the Art Report, FHWA/RD-81/042, a report prepared for the Federal Highway Administration by Envirex, Inc., Milwaukee, WI.

Gupta, M.K., Agnew, R.W., and Kreutzberger, W., 1981b, Constituents of Highway Runoff Vol. II: Procedural Manual for Monitoring of Highway Runoff, FHWA/RD-81/043, a report prepared for the Federal Highway Administration by Envirex, Inc., Milwaukee, WI.

Gupta, M.K., Agnew, R.W., Gruber, D., and Kreutzberger, W., 1981c, Constituents of Highway Runoff Vol. IV: Characteristics of Runoff from Operating Highways, Research Report, FHWA/RD-81/045, a report prepared for the Federal Highway Administration by Envirex, Inc., Milwaukee, WI.

Gupta, M.K., 1981d, Constituents of Highway Runoff Vol. VI: Executive Summary, FHWA/RD-81/047, a report prepared for the Federal Highway Administration by Envirex, Inc., Milwaukee, WI.

Haan, C.T., Barfield, B.J., and Hayes, J.C., 1994, Design Hydrology and Sedimentology for Small Catchments, Academic Press, New York, 588 pp.

Haan, C.T., and Ward, A.D., 1978, Evaluation of Detention Basins for Controlling Urban Runoff and Sedimentation, Water Resources Research Institute, University of Kentucky, Lexington, KY.

Habibi, K., 1973, "Characterization of Particulate Matter in Vehicle Exhaust," Environmental Science and Technology, Vol. 7, No. 3, pp. 223-234.

Hainly, R.A., 1980, The Effects of Highway Construction on Sediment Discharge into Blockhouse Creek and Steam Valley Run, Pennsylvania, U.S.G.S. Water-Resources Investigations 80-68.

Hall, W.C., and Naik, S.M., 1989, Determination of Effectiveness of Required Environmental Mitigation Activities Related to the Construction of Highways in Florida, FL/DOT/SMO/89-347, Florida Department of Transportation, Gainesville, Fl.

Hamilton, R.S., and Harrison, R.M., 1991, Highway Pollution, Studies in Environmental Science, Vol. 44, Elsevier Science Publishing, New York, 510 pp.

Hamilton, R.S., Revitt, D.M., Warren, R.S., and Duggan, M.J., 1987, "Metal Mass Balance Studies Within a Small Highway Dominated Catchment," The Science of the Total Environment, Vol. 59, pp. 365-368.

Hampson, P.S., 1986, Effects of Detention on Water Quality of Two Stormwater Detention Ponds Receiving Highway Surface Runoff in Jacksonville, Florida, USGS Water-Resources Investigations Report 86-4151.

Harned, D.A., 1988, Effects of Highway Runoff on Streamflow and Water Quality in the Sevenmile Creek Basin, A Rural Area in the Piedmont Province of North Carolina, July 1981 to July 1982, USGS Water Supply Paper 2329.

Harper, H.H., and Herr, J.L., 1992, "Stormwater Treatment Using Alum," Public Works, Vol. 123, No. 10, pp. 47-49, 89-90.

Harper, H. H., Yousef, Y.A., and Wanielista, M.P., 1984, "Efficiency of Roadside Swales in Removing Heavy Metals from Highway Associated Nonpoint Source Runoff," Options for Reaching Water Quality Goals, American Water Resources Association, pp. 129-137.

Harrington, B.W., 1989, "Design and Construction of Infiltration Trenches", Proceedings of an Engineering Foundation Conference on Current Practice and Design Criteria for Urban Quality Control, ASCE, New York, NY, pp. 290-306.

Harrison, R.M., Radojevic, M., and Wilson, S.J., 1986, "The Chemical Composition of Highway Drainage Waters IV: Alkyllead Compounds in Runoff Waters," The Science of the Total Environment, Vol. 50, pp. 129-137.

Harrison, R.M., and Johnston, W.R., 1985, "Deposition Fluxes of Lead, Cadmium, Copper, and Polycyclic Aromatic Hydrocarbons on the Verges of a Major Highway," The Science of the Total Environment, Vol. 46, pp. 121-135.

Harrison, R.M., and Wilson, S.J., 1985a, "The Chemical Composition of Highway Drainage Waters I: Major Ions and Selected Trace Metals," The Science of the Total Environment, Vol. 43, pp. 63-77.

Harrison, R.M., and Wilson, S.J., 1985b, "The Chemical Composition of Highway Drainage Waters II: Chemical Associations of Metals in the Suspended Sediment," The Science of the Total Environment, Vol. 43, pp. 79-87.

Harrison, R.M., and Wilson, S.J., 1985c, "The Chemical Composition of Highway Drainage Waters III: Runoff Water Metal Speciation Characteristics," The Science of the Total Environment, Vol. 43, pp. 89-102.

Helm, R.E., 1978, Sediment Discharge from Highway Construction Near Port Carbon, Pennsylvania, USGS Water-Resources Investigations 78-35.

Helsel, D.R., 1984, Contributions of Suspended Sediment from Highway Construction and Other Land Uses to the Olentangy River, Columbus, Ohio, USGS Water Resources Investigations Report 84-4336.

Hewitt, C.H., and Rashed, M.B., 1992 "Removal Rates of Selected Pollutants in the Runoff Waters from a Major Rural Highway," Water Research, Vol. 26, No. 3, pp. 311-319.

Hewitt, C.H., and Rashad, M.B., 1990, "An Integrated Budget for Selected Pollutants for a Major Rural Highway," The Science of the Total Environment, Vol. 93, pp. 375-384.

Highway Research Board, 1973, Erosion Control on Highway Construction, National Cooperative Highway Research Program, Synthesis of Highway Practice 18, 52 p.

Hittman Associates, Inc., 1976, "Methods to Control Fine Grained Sediments Resulting from Construction Activity," WA-RD 200.1, Washington DC.: Environmental Protection Agency, Office of Water Planning and Standards.

Hoffman, E.J., Latimer, J.S., Hunt, C.D., Mills, G.L., and Quinn, J.G., 1985, "Stormwater Runoff from Highways," Water, Air, and Soil Pollution, Vol. 25, No. 4, pp. 349-364.

Holler, J.D., 1990, "Nonpoint Source Phosphorus Control by a Combination Wet Detention/Filtration Facility in Kissimmee, Florida", Florida Scientist, Vol. 53, No. 1, pp. 28-37.

Hollis, G.E., and Ovenden, J.C., 1988, "Quantity of Stormwater Runoff from Ten Stretches of Road, a Car Park and Eight Roofs in Hertfordshire, England During 1983," Hydrological Processes, Vol. 2, No. 3, pp. 227-243.

Horner, R.R., Guedry, J., and Kortenhof, M.H., 1990a, Improving the Cost Effectiveness of Highway Construction Site Erosion and Pollution Control: Final Report, FHA/WA-RD 200.1, Washington State Department of Transportation, Olympia, WA.

Horner, R.R., Guedry, J., and Kortenhof, M.H., 1990b, Highway Construction Site Erosion and Pollution Control Manual, WA-RD 200.2, Washington State Department of Transportation, Olympia, WA.

Horner, R.R., 1985a, Highway Runoff Water Quality Research Implementation Manual: Volume 1, Water Quality Criteria, WA-RD 72.1, Washington State Department of Transportation, Planning Research and Public Transportation Division, Olympia, WA.

Horner, R.R., 1985b, Highway Runoff Water Quality Research Implementation Manual: Volume 2, Basis of Water Quality Criteria, WA-RD 72.2, Washington State Department of Transportation, Planning Research and Public Transportation Division, Olympia, WA.

Horner, R.R., 1985c, Suggested Revisions to WSDOT Manuals for Implementing Washington State Highway Runoff Water Quality Research Results, WA-RD 72.3, Washington State Department of Transportation, Planning Research and Public Transportation Division, Olympia, WA.

Horner, R.R., and Mar, B.W., 1983, "Guide for Water Quality Impact Assessment of Highway Operations and Maintenance," Transportation Research Record 948, p. 31-40.

Horner, R.R., and Welch, E.B., 1982, Impacts of Channel Reconstruction in the Pilchuck River, WA-RD-39.15, Washington State Department of Transportation, Olympia, WA.

Horner, R.R., Burges, S.J., Ferguson, J.F., Mar, B.W., and Welch, E.B., 1979, Highway Runoff Monitoring: The Initial Year, WA-RD-39.3, Washington State Department of Transportation, Olympia, WA.

Howell, R.B., Nakao, D.I., and Gidley, J.L., 1979, Analysis of Short and Long Term Effects on Water Quality for Selected Highway Projects, NTIS PB 80-196165, California State Department of Transportation, Sacramento, CA.

Howell, R.B., 1978a, Water Pollution Aspects of Particles Which Collect on Highway Surfaces, FHWA-CA-78-22, California Department of Transportation, Sacramento, CA.

Howie, B., and Waller, B.G., 1986, Chemical Effects of Highway Runoff on the Surficial Aquifer, Boward County, Florida, USGS Water Resources Investigations Report 86-4200.

Huber, W.C., 1985, "Deterministic Modeling of Urban Runoff Quality," in Torno, H.C., Marsalek, J., and Desbordes, M. eds., Urban Runoff Pollution, a NATO Advanced Workshop, Montpellier, France 1985, Proceedings: Berlin, Springer-Verlag, NATO ASI Series G, Ecological Sciences, Vol. 10, pp. 167-242.

Huber, W.C., and Heaney, J.P., 1982, "Analyzing Residuals Generation and Discharge from Urban and Nonurban Land Surfaces," Analyzing Natural Systems, eds. D.J. Basta and B.T. Bower, Resources for the Future, Inc., EPA-600/3-83-046 (NTIS PB83-223321).

Hvitved-Jacobsen, T., Yousef, Y.A., Wanielista, M.P., and Pearce, D.B., 1984, "Fate of Phosphorus and Nitrogen in Ponds Receiving Highway Runoff," The Science of the Total Environment, Vol. 33, pp. 259-270.

Hydroscience, Inc., 1979, A Statistical Method for Assessment of Urban Stormwater Loads - Impacts - Controls, EPA 440/3-79-023.

Irwin, G.A., and Losey, G.T., 1978, Water-Quality Assessment of Runoff from a Rural Highway Bridge Near Tallahassee, Florida, USGS Water Resources Investigations 79-1.

Israelson, C.E., et al., 1980, "Erosion Control During Highway Construction," NCHRP Report 221, Transportation Research Board, Washington, DC.

Jackura, K.A., 1980, Infiltration Drainage of Highway Surface Water, FHWA/CA/TL-80/04, California Department of Transportation, Sacramento, CA.

James, W. and Boregowda, S., 1985, "Continuous Mass-Balance of Pollutant Build-up Processes," in Torno, H.C., Marsalek, J., and Desbordes, M. eds., Urban Runoff Pollution, a NATO Advanced Workshop, Montpellier, France 1985, Proceedings: Berlin, Springer-Verlag, NATO ASI Series G, Ecological Sciences, Vol. 10, pp. 243-271.

Jewell, T.K. and Adrian, D.D., 1982, "Statistical Analysis to Derive Improved Stormwater Quality Models," Journal Water Pollution Control Federation, Vol. 54, pp. 489-499.

Jodie, J.B., 1975, "Quality of Urban Freeway Storm Water," Transportation Research Record, 556, pp. 1-5.

Jones, P.H., Jeffrey, B.A., Watler, P.K., and Hutchon, H., 1992, "Environmental Impact of Road Salting," in Chemical Deicers and the Environment, Lewis Publishers, Boca Raton, Florida.

Kent, E.J., Yu, S.L., and Wyant, D.C., 1982, "Drainage Control Through Vegetation and Soil Management," Transportation Research Record, 896, pp. 39-46.

Kerri, K.D., Howell, R.B., and Racin, J.A., 1985, "Forecasting Pollutant Loads from Highway Runoff," Transportation Research Record, 1017, pp. 39-46.

Kibler, D.F., ed., 1982, Urban Stormwater Hydrology, Washington, DC., Water Resources Monograph 7, 271 pp.

Kile, D.D., and Wendland, W.D., 1989, "Detention and Filtration Out of Sight, Out of Mind," National Water Conference-Proceedings of the Specialty Conference, ASCE, New York, NY, pp. 375-382.

Kilpatrick, F.A., Kaehrle, W.R., Hardee, J., Cordes, E.H., and Landers, M.N., 1985, Development and Testing of Highway Storm-Sewer Flow Measurement and Recording System, U.S. Geological Survey Water-Resources Investigations Report 85-4111.

King County Department of Public Works, 1990, "Surface Water Design Manual," Surface Water Management Division.

Kobriger, N.K., and Gupta, M.K., 1984a, Sources and Migration of Highway Runoff Pollutants, Vol. II: Methods, FHWA/RD-84/058 Federal Highway Administration, Washington, DC.

Kobriger, N., and Geinopolos, A., 1984b, Sources and Migration of Highway Runoff Pollutants, Vol. III: Research Report, FHWA/RD-84/059, Federal Highway Administration, Washington, DC.

Kobriger, N.K., 1984c, Sources and Migration of Highway Runoff Pollutants, Vol. IV: Appendix, FHWA/RD-84/060, Federal Highway Administration, Washington, DC.

Kobriger, N., Meinholz, T.L., Gupta, M.K., and Agnew, R.W., 1981a, Constituents of Highway Runoff, Vol. III: Predictive Procedure for Determining Pollutant Characteristics in Highway Runoff, FHWA/RD-81/044, Federal Highway Administration, Washington, DC.

Kobriger, N.P., and Krischan, T.M., 1981b, Constituents of Highway Runoff, Vol. V: Highway Runoff Data Storage Program and Computer User's Manual, FHWA/RD-81/046, a report prepared for the Federal Highway Administration by Envirex, Inc., Milwaukee, WI.

Koerner, R.M., 1986, Designing with Geosynthetics, Prentice Hall, Englewood Cliffs, N.J.

Kouwen, N., 1990, "Silt Fences to Control Sediment Movement on Construction Sites, MAT-90-02," The Research and Development Branch Ontario Ministry of Transportation, 30 pp.

Kramme, A.D., and Brosnan, T.M., 1985a, Investigations of Impacts of Selected Highway Maintenance Practices on Water Quality -- Vol. II, FHWA/ RD-85/058, Federal Highway Administration, Washington, DC.

Kramme A.D., Rolan, R.G., and Smith, L.A., 1985b, Reference Manual for Assessing Water Quality Impacts from Highway Maintenance Practices - Vol. III, FHWA/RD-85/059, Federal Highway Administration, Washington, DC.

Kramme, A.D., Rolan, R.G., Roth L.B., and Everhart, B.F., 1985c, Guidelines Manual for Minimizing Water Quality Impacts from Highway Maintenance Practices - Vol. IV, FHWA/RD-85/060, Federal Highway Administration, Washington, DC.

Kroll, C.G., 1976, Sediment Discharge from Highway Cut-Slopes in the Lake Tahoe Basin, California, 1972-1974, USGS Water-Resources Investigations Report 76-19.

Kszos, K.A., Winter, J.D., and Storch, T.A., 1990, "Toxicity of Chautauqua Lake Bridge Runoff to Young-of-the-Year Sunfish (*Lepomis macrochirus*)," Bulletin of Environmental Contamination and Toxicology, Vol. 45, No. 6, p 923-930.

Ku, H.F.H., and Simmons, D.L., 1986, Effect of Urban Stormwater Runoff on Ground Water Beneath Recharge Basins on Long Island, New York, USGS Water-Resources Investigations Report 85-4088.

Kuo, C.Y., Zhu, J.L., and Dollard, L.A., 1989, "Infiltration Trenches for Urban Runoff Control," Proceedings of the 1989 National Conference on Hydraulic Engineering, ASCE, New York, NY, pp. 1029-1034.

Lagerwerff, J.V., and Specht, A.W., 1970, "Contamination of Roadside Soil and Vegetation with Cadmium, Nickel, Lead, and Zinc," Environmental Science and Technology, Vol. 4, No. 7, pp. 583-586.

Lange, G., 1990, "The Design and Construction of Treatment Processes for Highway Runoff in the FRG," The Science of the Total Environment, Vol. 93, pp. 499-506.

Laxen, D.P.H., and Harrison, R.M., 1981, "A Scheme for the Physico-Chemical Speciation of Trace Metals in Freshwater Samples," The Science of the Total Environment, Vol. 19, pp. 499-506.

Laxen, D.P.H., and Harrison, R.M., 1977, "The Highway as a Source of Water Pollution: An Appraisal of the Heavy Metal Lead," Water Research, Vol. 11, pp. 1-11.

Lindner-Lundsford, J.B., and Ellis, S.R., 1987, Comparison of Conceptually Based and Regression Rainfall-Runoff Models, Denver Metropolitan Area, Colorado, and Potential Application in Urban Areas, USGS Water-Resources Investigations Report 87-4104, 39 pp.

Little, L.M., Horner, R.R., and Mar, B.W., 1982, Assessment of Pollutant Loadings and Concentrations in Highway Stormwater Runoff, WA-RD-39.12.1, Washington State Department of Transportation, Olympia, WA.

Little, P., and Wiffen, R.D., 1978, "Emission and Deposition of Lead from Motor Exhausts--II: Airborne Concentrations, Particle Size, and Deposition of Lead near Motorways," Atmospheric Environment, Vol. 12, pp. 1331-1341.

Loague, K.M., and Freeze, R.A., 1985, "A Comparison of Rainfall-Runoff Modeling Techniques on Small Upland Catchments," Water Resources Research, Vol. 21, pp. 229-248.

Lord, B.N., 1987, "Nonpoint Source Pollution from Highway Stormwater Runoff," The Science of the Total Environment, Vol. 59, pp. 437-446.

McBean, E.A., and Burn, D.H., 1983, "Discussion of Pollutant Loading Model for Highway Runoff," Journal of Environmental Engineering 109, No. EE6, pp. 1452-1453.

Madigosky, S.R., Alvarez-Hernandez, X., and Glass, J., 1991, "Lead, Cadmium, and Aluminum Accumulation in the Red Swamp Crayfish *Procambarus CLARKII* G. Collected from Roadside Drainage Ditches in Louisiana," Archives of Environmental Contamination and Toxicology, Vol. 20, No. 2, pp. 253-258.

Maestri, B., and Lord, B.N., 1987, "Guide for Mitigation of Highway Stormwater Runoff Pollution," The Science of the Total Environment, Vol. 59, pp. 467-476.

Maestri, B., Johnson, F., Burch, C.W., and Dawson, B., 1985a, Management Practices for Mitigation of Highway Stormwater Runoff Pollution, Vol. III: Research Report, FHWA/RD-85/003, Federal Highway Administration, McLean, VA.

Maestri, B., Burch, C.W., and Johnson, F., 1985b, Management Practices for Mitigation of Highway Stormwater Runoff Pollution, Vol. IV: Executive Summary, FHWA/RD-85/004, Federal Highway Administration, McLean, VA.

Mar, B.W. et al., 1982, Washington State Highway Runoff Water Quality Study 1977-1982, WA-RD-39.16, Washington State Department of Transportation, Olympia, WA.

Maristnay, A.E., 1989, "Effectiveness of Wet Detention and Retention Ponds for Improving Stormwater Quality," Proceedings of the 1989 National Conference on Hydraulic Engineering, ASCE, New York, NY, pp. 1047-1052.

Martin, E.H., 1989, "Mixing and Residence Times of Stormwater Runoff in a Detention System," Proceedings of an Engineering Foundation Conference on Current Practice and Design Criteria for Urban Quality Control, ASCE, New York, NY, pp. 164-179.

Martin, J.S., 1985, "Use of Silt Fences for Control of Sediment Runoff," Erosion Control ... A Challenge in Our Time, Proceedings of International Erosion Control Association, San Francisco, California, 21-22 February, Pinole, California.

Maryland Department of Natural Resources, 1986, Minimum Water Quality Objectives and Planning Guidelines for Infiltration Practices, Water Resources Administration, Sediment and Stormwater Division, Annapolis, MD.

Maryland Department of the Environment, Sediment and Stormwater Administration, 1985, Inspector's Guidelines Manual for Stormwater Management Infiltration Practices, Baltimore, MD.

Maryland Department of the Environment, Sediment and Stormwater Administration, 1984a, Standards and Specifications for Infiltration Practices, Baltimore, MD.

Maryland Department of the Environment, Sediment and Stormwater Administration, 1984b, Feasibility and Design of Wet Ponds to Achieve Water Quality Control, Baltimore, MD.

McKenzie, D.J., and Irwin, G.A., 1988, Effects of Two Stormwater Management Methods on the Quality of Water in the Upper Biscayne Aquifer at Two Commercial Areas in Dade County, Florida, USGS Water Resources Investigations 88-4069.

McKenzie, D.J., and Irwin, G.A., 1983, Water-Quality Assessment of Stormwater Runoff from a Heavily Used Urban Highway Bridge in Miami, Florida, USGS Water Resources Investigations 83-4153 (FHWA/FL/BMR-84-270).

McLeese, R.L., and Whiteside, E.P., 1977, "Ecological Effects of Highway Construction Upon Michigan Woodlots and Wetlands: Soil Relationships," Journal of Environmental Quality, Vol. 6, No. 4, pp. 467-471.

Metropolitan Washington Council of Governments (MWCOC), 1983, Nationwide Urban Runoff Program: Pollutant Removal Capability of Urban Best Management Practices in the Washington Metropolitan Area, Final Report, Water Resources Planning Board, Washington, DC.

Meyer, G.J., Schoeneberger, P.J., and Huddleston, J.H., 1975, "Sediment Yields from Roadside: an Application of the Universal Soil Loss Equation," J. Soil Wat. Conserv., Vol. 30, pp. 289-291.

Milberg, R.P., Lagerwerff, J.V., Brower, D.L., Biersdorf, G.T., 1980, "Soil Lead Accumulation Alongside a Newly Constructed Roadway," Journal of Environmental Quality, Vol. 9, No. 1, pp. 6-8.

Miller, A.C., Veon, W.J., and Chadderton, R.A., 1982, "Comparison of Prediction Methods for Soil Erosion from Highway Construction Sites," Transportation Research Record 896, pp. 33-39.

Miller, R.A., Matraw, Jr., H.C., and Jennings, M.E., 1978, "Statistical Modeling of Urban Storm Water Processes, Broward County, Florida," International Symposium on Urban Storm Water Management, University of Kentucky, Lexington.

Milligan, J.D., and Betson, R.P., 1985, "The Effects of Carbonate Geology on Urban Runoff: Part 2 - Water Quality Aspects," In: Perspectives on NonPoint Source Pollution, Proceedings of a National Conference, Kansas City, MO, May 19-22.

Miracle, D.L., 1986, Review of Existing Methods for Predicting Pollutant Loads from Highway Runoff, Master of Engineering Technical Report (unpublished), University of Florida, Department of Environmental Engineering Sciences, Gainesville.

Mitchell, G.F., 1993, Assessment of Erosion/Sediment Control in Highway Construction Projects, Ohio Department of Transportation, FHWA/OH-93/011.

Moe, R.D., Bullin, J.A., and Loughheed, M.J., Jr., 1982, Atmospheric Particulate Analysis and Impact of Highway Runoff on Water Quality in Texas, FHWA/TX-82/30+191-1F, Texas State Department of Highways and Public Transportation, Austin, TX.

Moe, R.D., Bullin, J.A., and Polasek, J.C., 1978, Characteristics of Highway Runoff in Texas, FHWA-RD-78-197, Federal Highway Administration, Washington, DC.

Morrison, G.M.P., Revitt, D.M., and Ellis, J.B., 1990, "Metal Speciation in Separate Stormwater Systems," Water Science and Technology, Vol. 22, No. 10/11, pp. 53-60.

Morrison, G.M.P., Revitt, D.M., Ellis, J.B., Svenson, G., and Balmer, P., 1988, "Transport Mechanisms and Processes for Metal Species in a Gullypot System," Water Res., Vol. 22, pp. 1417-1427.

Mudre, J.M., and Ney, J.J., 1986, "Patterns of Accumulation of Heavy Metals in the Sediment of Roadside Streams," Archives of Environmental Contamination and Toxicology, Vol. 15, No. 5, pp. 489-493.

Nawrocki, M., and Peitzak, J., 1976, Methods to Control Fine-grained Sediments Resulting from Construction Activity, EPA 440/9-76-026, U. S. Environmental Protection Agency.

Nightingale, H.I., 1987, "Accumulation of As, Ni, Cu, and Pb in Retention and Recharge Basins Soils from Urban Runoff," Water Resources Bulletin, Vol. 23, No. 4, pp. 663-672.

Nix, S.J., 1982, "Analysis of Storage/Release Systems in Urban Stormwater Quality Management," Ph.D. Dissertation, Dept. of Environmental Engineering Sciences, University of Florida, Gainesville.

Parizek, R.R., 1971, "Impact of Highways on the Hydrogeologic Environment," in Environmental Geomorphology, Donald R. Coates, editor, Proceedings of the 1st Annual Geomorphology Symposia Series, Binghamton, NY, Oct. 16-17, 1970, pp. 151-199.

Pazwash, H., 1991, "Maintenance of Stormwater Management Facilities: Neglects in Practice," Proceedings of the National Conference on Hydraulic Engineering, ASCE, New York, NY, pp. 1072-1077.

Peterson, S.A., Miller, W.E., Greene, J.C., and Callahan, C.A., 1985, "Use of Bioassays to Determine Potential Toxicity Effects of Environmental Pollutants," Perspectives on Nonpoint Source Pollution, pp. 38-45.

Pitt, R., 1979, Demonstration of Non-Point Pollution Abatement Through Improved Street Cleaning Practices, U.S. Environmental Protection Agency Report No. EPA 600/2-79-161.

Pitt, R.E., and Amy, G., 1973, "Toxic Materials Analysis of Street Surface Contaminants," URS Research Company for the U.S. EPA, Office of Research and Monitoring Environmental Protection Series Report No. EPA-R2-72-283.

Pope, L.M., and Hess, L.G., 1989, "Load-Detention Efficiencies in a Dry-Pond Basin," Proceedings of an Engineering Foundation Conference on Current Practice and Design Criteria for Urban Quality Control, ASCE, New York, NY, pp. 258-267.

Pope, W., Graham, N.J.D., Young, R.J., and Perry, R., 1978, "Urban Runoff from a Road Surface—A Water Quality Study," Prog. Wat. Technol., Vol. 10, No. 5/6, pp. 533-544.

Portele, G.J., Mar, B.W., Horner, R. R., and Welch, E.B., 1982, Effects of Seattle Area Highway Stormwater Runoff on Aquatic Biota, WA-RD-39.11, Washington State Department of Transportation, Olympia, WA.

Racin, J.A., Howell, R.B., Winters, G.R., and Shirley, E.C., 1982, Estimating Highway Runoff Quality, FHWA/CA/TL-82/11, California Department of Transportation, Sacramento, CA.

Reed, J.R., Jr., 1977, "Stream Community Response to Road Construction Sediments," Virginia Water Resources Research Center, Blacksburg , Bulletin 97, 61 p.

Reed, L.A., Ward, J.R., and Wetzel, K.L., 1985, Calculating Sediment Discharge from a Highway Construction Site in Central Pennsylvania, USGS Water-Resources Investigations Report 83-4216.

Reed, L.A., 1980, Suspended-Sediment Discharge in Five Streams near Harrisburg., PA, Before, During, and After Highway Construction, USGS Water-Supply Paper 2072.

Revitt, D.M., and Ellis, J.B., 1980, "Rain Water Leachates of Heavy Metals in Road Surface Sediments," Water Research, Vol. 14, No. 10, pp. 1403-1407.

Richardson, E.V., 1974, Highways in the River Environment: Design Considerations, Civil Engineering Research Center, Colorado State University, Fort Collins, CO.

Roenigk, D.J., Paterson, R.G., Heraty, M.A., Kaiser, E.J., and Burby, R.J., 1992, Evaluation of Urban Stormwater Maintenance in North Carolina, Department of City and Regional Planning, University of North Carolina, Chapel Hill, NC.

Rollin, A.L., 1986, "Filtration Opening Size of Geotextiles," *ASTM Standardization News*, May, pp. 50-53.

Sartor, J.D., and Boyd, G.B., 1973, "Water Quality Improvement through Control of Road Surface Runoff," Water Pollution Control in Low Density Areas: Proceedings of a Rural Environmental Engineering Conference September 26-28, 1973, Warren, Vermont, University Press of New England, Hanover, New Hampshire, pp. 301-316.

Sartor, J.D., and Boyd, G.B., 1972, Water Pollution Aspects of Street Surface Contaminants, URS Research Company for the U.S. EPA, Office of Research and Monitoring, Environmental Protection Series EPA-R2-72-081.

Saylak, D., Deuel, L.E., Izatt, J.O., Jacobs, C., Zahray, R., and Ham, S., 1980, Environmental and Safety Aspects of the Use of Sulfur in Highway Pavements - Vol. I: Evaluation of Environmental and Safety Hazards, FHWA/RD-80/191, Federal Highway Administration, Washington, DC.

Schiffer, D., 1989, Effects of Three Highway Runoff Detention Methods on Water Quality of the Surficial Aquifer System in Central Florida, USGS Water Resources Investigations Report 88-4170. A.K.A. "Impact of Stormwater Management Practices on Groundwater," FL/DOT/SMO/90-378, Florida Department of Transportation, Office of Materials and Research, Gainesville, FL.

Schiffer, D., 1988, Effects of Highway Runoff on the Quality of Water and Bed Sediments of Two Wetlands in Central Florida, USGS Water Resources Investigations Report 88-4200, A.K.A. Wetlands for Stormwater Treatment, FL/DOT/SMO/90-377, Florida Department of Transportation, Office of Materials and Research, Gainesville, FL..

Schueler, T.R., 1987, Controlling Urban Runoff: A Practical Manual for Planning and Designing Urban BMPs, Department of Environmental Programs, Metropolitan Washington Council of Governments, Washington, DC.

Schueler, T.R., Kumble, P.A., and Heraty, M.A., 1991, A Current Assessment of Urban Best Management Practices, Techniques for Reducing Non-Point Source Pollution in the Coastal Zone, *Review Draft*, Anacostia Restoration Team, Department of Environmental Programs, Metropolitan Washington Council of Governments, Washington, DC.

Schueler, T.R., and Lugbill, J., 1990, Performance of Current Sediment Control Measure at Maryland Construction Sites, Metropolitan Washington Council of Governments.

Segarra-Garcia, R., and V. G. Loganathan, 1992, "Storm-Water Detention Storage Design Under Random Pollutant Loading," *Journal of Water Resources Planning and Management (ASCE)*, Vol. 118, No. 5, pp. 475-491.

Shaheen, D.G., 1975, Contributions of Urban Roadway Usage to Water Pollution, EPA 600/2-75-004 Environmental Protection Agency, Washington, DC.

Shelley, P.E., Driscoll, E.D., and Sartor, J.D., 1987, "Probabilistic Characterization of Pollutant Discharges from Highway Stormwater Runoff," Science of the Total Environment, Vol. 59, pp. 401-410.

Silverman, G.S., and Stenstrom, M.K., 1989, "Source Control of Oil and Grease in an Urban Area," Proceedings of an Engineering Foundation Conference on Current Practice and Design Criteria for Urban Quality Control, ASCE, New York, NY, pp. 403-420.

Smith, D.L., and Lord, B.M., 1990, "Highway Water Quality Control - Summary of 15 Years of Research," Transportation Research Record, 1279, pp. 69-74.

Smith, M.E., and Kaster, J.L., 1983, "Effect of Rural Highway Runoff on Stream Benthic Macroinvertebrates," *Environmental Pollution (Series A)* Vol. 32, No. 3, pp. 157-170.

Spangberg, A., and Niemczynowicz, J., 1992, "High Resolution Measurements of Pollution Wash-Off from an Asphalt Surface," Nordic Hydrology, Vol. 23, No. 4, pp. 245-256.

Spooner, A.E., and Murdoch, C.L., 1970, Erosion Control on Highway Rights-of-Way in Arkansas, Highway Research Project No. 15, Final Report, NTIS Pb-194-017.

Stahre, P., and Urbonas, B., 1990, Stormwater Detention For Drainage, Water Quality, and CSO Management, Prentice Hall, Englewood Cliffs, NJ.

Stahre, P., and Urbonas, B., 1989, "Swedish Approach to Infiltration and Percolation Design," Proceedings of an Engineering Foundation Conference on Current Practice and Design Criteria for Urban Quality Control, ASCE, New York, NY, pp. 307-323.

Stotz, G., 1987, "Investigations of the Properties of the Surface Water Runoff from Federal Highways in the FRG," The Science of the Total Environment, Vol. 59, pp. 329-337.

Suits, L.D., 1986, "Geotextile Permeability and Filtration," ASTM Standardization News, May, pp. 46-49.

Sullivan, R., and Foote, L.E., 1984, "Roadside Erosion Causes and Factors: Minnesota Survey Analysis," Transportation Research Record, Vol. 948, pp. 47-54

Swerdon, P.M., and Kountz, R.R., 1973, "Sediment Runoff Control at Highway Construction Sites," Pennsylvania State University, Engineering Res. Bull. B-108, 120 pp.

Tan, K.H., and Thirumurthi, D., 1978, "Highway Construction Impacts on Water-Supply Lakes," Journal of the Environmental Engineering Division of ASCE, Vol. 104, No. EE5, pp. 997-1011.

Teamah, J.A., 1993, "An Investigation of Woven and Nonwoven Geotextiles in Silt Fence, Publication 3-J-3-158," Texas Department of Transportation.

Texas Department of Transportation (TxDOT), 1992, "National Pollutant Discharge Elimination System, Guidelines for Compliance with the General Permit for Construction Activities."

Theisen, M.S., 1990, "The Role of Geosynthetics in Erosion and Sediment Control—an Overview," Geotextiles and Geomembranes, Vol. 11, No. 4-6, pp. 535-550.

Thrasher, M.H., 1983, "Highway Impacts on Wetlands: Assessment, Mitigation, and Enhancement Measures," Transportation Research Record, 948, pp. 17-20.

Thronson, R.E., 1971, Control of Sediments Resulting From Highway Construction and Land Development, EPA Office of Water Programs Report, 50 p.

Toet, C. Hvitved-Jacobsen, T., and Yousef, Y.A., 1990, "Pollutant Removal and Eutrophication in Urban Runoff Detention Ponds," Water Science and Technology, Vol. 22, No. 10/11, p 197-204.

Umeda, P.J., 1988, Use of Vegetation to Reduce the Toxicity of Stormwater Runoff, FHWA/CA/TL-88/06, California Department of Transportation, Sacramento, CA.

U.S. Environmental Protection Agency, 1983, Final Report of the Nationwide Urban Runoff Program, Vol. I, Water Planning Division, Washington, DC.

U.S. Environmental Protection Agency, 1976, Areawide Assessment Procedures Manual, EPA-600/9-76-014.

Van Hassel, J.H., Ney, J.J., and Garling, D.L., Jr., 1980, "Heavy Metals in a Stream Ecosystem at Sites Near Highways," Transactions of the American Fisheries Society, Vol. 109, No. 6, pp. 636-643.

Versteeg, J.H., and Earley, J.J., 1982, "Erosion Control at a Delicate Highway Construction Site," Public Works Vol. 113, No. 3, p 82-83.

Vice, R.B., Guy, H.P., and Ferguson, G.E., 1969, Sediment Movement in an Area of Suburban Highway Construction, Scott Run Basin, Fairfax County, Virginia, 1961-64, USGS Water Supply Papers 1591-E, pp. E1-E41.

Wada, Y., and Miura, H., 1984, "Quantification of Accumulated Loads on Road Surfaces and Their Runoff Characteristics," Water Science and Technology, Vol. 16, No. 5-7, pp. 463-472.

Wall, G.J., 1991, "The Effectiveness of Surficial Erosion Control Products," MAT-91-07, Ontario Department of Transportation, 55 pp.

Waller, B.G., Klein, H., and Lefkoff, L.J., 1984, Attenuation of Stormwater Contaminants from Highway Runoff Within Unsaturated Limestone, Dade County, Florida, USGS Water Resources Investigations Report 84-4083.

Wang, T.S., Spyridakis, D.E., Mar, B.W., and Horner, R.R., 1980, Transport, Deposition, and Control of Heavy Metals in Highway Runoff, WA-RD-39.10, Washington State Department of Transportation, Olympia, WA.

Wanielista, M.P., Charba, J., Dietz, J., Lott, R.S., and Russell, B., 1991, Evaluation of the Stormwater Treatment Facilities at the Lake Angel Detention Pond Orange County, Florida, FL/DOT/RMC/3361, Florida Department of Transportation, Tallahassee, FL.

Wanielista, M.P. et al., 1988a, Alternatives for the Treatment of Groundwater Contaminants: Infiltration Capacity of Roadside Swales, FL-ER-38-88, Florida Department of Transportation, Tallahassee, FL.

Wanielista, M.P., Yousef, Y.A., and Boss, C., 1988b, Alternatives for the Treatment of Groundwater Contaminants: A Detention Pond with Groundwater Inflow, FL-ER-40-88, Florida Department of Transportation, Tallahassee, FL.

Wanielista, M.P., Yousef, Y.A., Van DeGroaff, L.M., and Rehmann-Koo, S.H., 1986, Best Management Practices - Enhanced Erosion and Sediment Control Using Swale Blocks, FL/DOT/BMR-85-293, Florida Department of Transportation, Tallahassee, FL.

Wanielista, M.P., Yousef, Y.A., and Christopher, J.E., 1980, Final Report on Management of Runoff from Highway Bridges, FL-ER-10-80, Florida Department of Transportation, Tallahassee, FL.

Wanielista, M.P., Gennaro, R.N., Bell, J.H., and Johnson, J.W., 1978, Shallow-Water Roadside Ditches for Stormwater Purification, FL-ER-3-78, Florida Department of Transportation.

Ward, N.I., 1990, "Multielement Contamination of British Motorway Environments," Science of the Total Environment, Vol. 93, pp. 393-401.

Ward, T.J., 1985, Sediment Yield Modelling of Roadways. In: Soil Erosion and Conservation, eds. S A. El-Swaify, W. C. Moldenhauer, and A. Lo, Soil Conservation Society of America, pp. 188-199.

Warren, R.S., and Birch, P., 1987, "Heavy Metal Levels in Atmospheric Particulates, Roadside Dust and Soil along a Major Urban Highway," Science of the Total Environment, Vol. 59, pp. 253-256.

Weber, W.G., Jr., and Reed, L.A., 1976, "Sediment Runoff During Highway Construction," ASCE Irrigation and Specialty Conference in Ottawa, Canada, July 1976.

Welborn, C.T., and Veenhuis, J.E., 1987, Effects of Runoff Controls on the Quality of Urban Runoff at Two Locations in Austin, Texas, USGS Water-Resources Investigations Report 87-4004.

Whipple, W., Jr., Kropp, R., and Burke, S., 1987, "Implementing Dual-Purpose Stormwater Detention Programs," Journal of Water Resources Planning and Management, Vol. 113, No. 6, pp. 779-792.

Whipple, W., Grigg, N.S., Grizzard, T.J., Randall, C.W., Shubinski, R.P., and Tucker, L.S., 1984, Stormwater Management in Urbanizing Areas, 234 pp., Prentice-Hall, Englewood Cliffs, NJ.

Wigington, P.J., Jr., Randall, C.W., and Grizzard, T.J., 1986, "Accumulation of Selected Trace Metals in Soils of Urban Runoff Swale Drains," Water Resources Bulletin, Vol. 22, No. 1, pp. 73-79.

Wiland, B., and Malina, J.F., Jr., 1976, Oil, Grease, and Other Pollutants in Highway Runoff, FHWA TX 77-16-1F, Center for Highway Research, University of Texas, Austin, TX.

Wilber, W.G., and Hunter, J.V., 1979, Distribution of Metals in Street Sweepings, Stormwater Solids, and Urban Aquatic Sediments,” Journal of the Water Pollution Control Federation, Vol. 51, pp. 2810-2822.

Winters, G.R., and Gidley, J.L., 1980, Effects of Roadway Runoff on Algae, FHWA/CA/TL-80/24, Federal Highway Administration, Washington, DC.

World Construction, 1986, “Geotextiles' Construction Role Grows Rapidly,” July, pp. 41-46.

Wright, D.L., Perry, H.D., and Blaser, R.E., 1976, Controlling Erosion Along Highways with Vegetation or Other Protective Cover, FHWA-VA-77-517, Federal Highway Administration, Washington, DC.

Wu, J.S., Holman, B., and Dorney, J., 1989, “Water Quality Study on Urban Wet Detention Ponds,” Proceedings of an Engineering Foundation Conference on Current Practice and Design Criteria for Urban Quality Control, ASCE, New York, NY, pp. 280-289.

Wulliman, J.T., Maxwell, M., Wenk, W., and Urbonas, B., 1989, “Multiple Treatment System for Phosphorus Removal,” Proceedings of an Engineering Foundation Conference on Current Practice and Design Criteria for Urban Quality Control, ASCE, New York, NY, pp. 239-257.

Wyant, D.C., Sherwood, W.C., and Walker, H.N., 1972, Erosion Prevention during Highway Construction by the Use of Sprayed on Chemicals, Virginia Highway Research Council, Charlottesville, NTIS Pub. No. Pb-213207.

Yamane, A., Nagashima, I., Okubo, T., Okada, M., and Murakami, A., 1990, “Stormwater Runoff of Hydrocarbons in the Tama River Basin in Tokyo (Japan) and Their Fate in the River,” Water Science and Technology, Vol. 22, No. 10/11, pp. 119-126.

Yew, C.P., and Makowski, P.B., 1989, “Water Quality Monitoring of Highway Construction,” Proceedings of the 1989 National Conference on Hydraulic Engineering, ASCE, New York, NY, pp. 157-162.

Yim, C.S., and Sternberg, Y.M., 1987, Development and Testing of Granular Filter Design Criteria for Stormwater Management Infiltration Structures (SWMIS), FHWA/MD-87/03, Federal Highway Administration, Washington, DC.

Younkin, L.M., 1973, Effects of Highway Construction on Sediment Loads in Streams, Highway Research Board Special Pbl. No. 135, 82-93.

Younkin, L.M., and Connelly, G.B., 1981, "Prediction of Storm-Induced Sediment Yield from Highway Construction," Transportation Research Record 832.

Yousef, Y.A., and Yu, L.L., 1992, "Potential Contamination of Groundwater from Cu, Pb, and Zn, in Wet Detention Ponds Receiving Highway Runoff," Journal of Environmental Science and Health, Part A: Environmental Science and Engineering, Vol. 27, No. 4, pp. 1033-1044.

Yousef, Y.A., Lin, L.Y., Sloat, J.V., and Kaye, K.Y., 1991, Maintenance Guidelines for Accumulated Sediments in Retention/Detention Ponds Receiving Highway Runoff, FL/DOT/RMC/0381-3286, Florida Department of Transportation, Tallahassee, FL.

Yousef, Y.A., Hvitved-Jacobsen, T., Wanielista, M.P., and Harper, H.H., 1987, "Removal of Contaminants in Highway Runoff Flowing Through Swales," The Science of the Total Environment, Vol. 59, pp. 391-399.

Yousef, Y.A., Hvitved-Jacobsen, T., Wanielista, M.P., and Tolbert, R.D., 1986a, "Nutrient Transformation in Retention/Detention Ponds Receiving Highway Runoff," Journal Water Pollution Control Federation, Vol. 58, No. 8, pp. 838-844.

Yousef, Y.A., Wanielista, M.P., Harper, H.H., and Hvitved-Jacobsen, T., 1986b, Best Management Practices - Effectiveness of Retention/Detention Ponds for Control of Contaminants in Highway Runoff, FL/DOT/BMR-86-307, Florida Department of Transportation, Tallahassee, FL.

Yousef, Y.A., Wanielista, M.P., and Harper, H.H., 1985a, "Removal of Highway Contaminants by Roadside Swales," Transportation Research Record, 1017, pp. 62-68.

Yousef, Y.A., Harper, H.H., Wiseman, L.P., and Bateman, J.M., 1985b, "Consequential Species of Heavy Metals in Highway Runoff," Transportation Research Record, 1017, pp. 56-61.

Yousef, Y.A., Harper, H.H., Wiseman, L., and Bateman, M., 1985d, Consequential Species of Heavy Metals, FL-ER-29-85, Florida Department of Transportation, Tallahassee, FL.

Yousef, Y.A., Wanielista, M.P., Hvitved-Jacobsen, T., and Harper, H.H., 1984, "Fate of Heavy Metals in Stormwater Runoff from Highway Bridges," The Science of the Total Environment, Vol. 33, pp. 233-244.

Yousef, Y.A., Wanielista, M.P., Harper, H.H., and Christopher, J.E., 1982, "Management of Drainage Systems from Highway Bridges for Pollution Control," Transportation Research Record, 896, pp. 51-54.

Yu, S.L., and Benelmouffok, D.E., 1988, "Field Testing of Selected Urban BMP's," Critical Water Issues and Computer Applications, Proceedings of the 15th Annual Water Resources Conference, ASCE, New York, NY, pp. 309-312.

Zawlocki, K.R., Ferguson, J.F., and Mar, B.W., 1980, Survey of Trace Organics in Highway Runoff in Seattle, Washington, WA-RD-39.9, Report to Washington State Department of Transportation by the Dept. of Civil Eng, Univ. of Washington, Seattle.

Zellhoefer, W.F., 1989, Investigation of Water Quality Impacts of Stormwater Runoff from the Robert E. Lee Bridge Richmond, Virginia, Virginia Department of Transportation, Richmond, VA.