

Copyright

by

Kan Long

2013

**The Thesis Committee for Kan Long  
Certifies that this is the approved version of the following thesis:**

**Quantitative Relationships between Crash Risks and Pavement Skid Resistance**

**APPROVED BY  
SUPERVISING COMMITTEE:**

**Supervisor:**

---

Zhanmin Zhang

---

Michael R. Murphy

**Quantitative Relationship between Crash Risks and Pavement Skid  
Resistance**

**by**

**Kan Long, B.S.; B.S.C.E.**

**Thesis**

Presented to the Faculty of the Graduate School of

The University of Texas at Austin

in Partial Fulfillment

of the Requirements

for the Degree of

**Master of Science in Engineering**

**The University of Texas at Austin**

**December 2013**

## **Dedication**

I dedicate this thesis to my family and friends who have continuously supported me throughout my life.

## **Acknowledgements**

I would like to express thanks to my advisor, Dr. Zhanming Zhang, for all his guidance and patience throughout the course work and in this research. I treasure every advice he gave me from class and meetings. I also want to thank Dr. Michael R. Murphy who has helped me editing this thesis. His passion has inspired me and I have learned a lot from him. I would like to thank the experts from TxDOT to provide great guidance in this study.

I want to thank the faculty and staff in Department of Civil, Architectural and Environmental Engineering who have helped and encouraged me in my study.

Last but not least, I want to thank my friends and family for their continuous support for me to pursue my dream.

## **Abstract**

# **Quantitative Relationship between Pavement Skid Resistance and Crash Risks**

Kan Long, M.S.E.

The University of Texas at Austin, 2013

Supervisor: Zhanmin Zhang

Faced with continuously increasing maintenance due to aging infrastructure, the Texas Department of Transportation (TxDOT) is evaluating the potential impact of reduced funding on highway safety. The main objective of this thesis is to develop a methodological procedure to identify threshold levels of pavement skid resistance for highways in the context of traffic crashes, assisting TxDOT Administration and engineers in making proper maintenance decisions. As a result, the efficiency and safety of the highway system could be preserved. The scope of this study covers all types of state-maintained highways in Texas. The primary objectives of this thesis include: 1) synthesis of literature; 2) quantification of the relationship between crash risk and pavement skid resistant; 3) determination of critical skid resistant threshold levels; and, 4) benefit cost analysis. A detailed methodology framework was developed and a comprehensive database was generated from four data files containing pavement, geometry, traffic, and crash information to support this research. The impact of skid resistance level on crash risks was proven to be significant based on the results of regression analysis and insights

provided by TxDOT experts. The quantitative relationships between crash risk and skid resistance were quantified using the Crash Rate Ratio method. Hierarchical structure grouping was used to categorize the entire network into homogeneous groups based on traffic level, roadway alignment and other factors. Critical skid resistance threshold levels were determined for the whole state as well as for stratified highway groups. Finally, benefit/cost ratio analyses were conducted to evaluate the effectiveness of pavement maintenance treatments to restore or increase skid resistance.

## Table of Contents

List of Tables .....	x
List of Figures .....	xi
<b>CHAPTER 1 : INTRODUCTION.....</b>	<b>1</b>
1.1 Background .....	1
1.2 Research Scope and Objectives .....	2
<b>CHAPTER 2 : LITERATURE REVIEW.....</b>	<b>4</b>
2.1 Management of Skid resistance .....	4
2.2 Evaluation of Safety Impact of Skid Resistance.....	14
2.3 Management of Skid Resistance in Texas .....	16
<b>CHAPTER 3 : METHODOLOGY.....</b>	<b>19</b>
3.1 Research Objective .....	19
3.2 Conceptual Framework.....	19
3.3 Crash Rate Ratio Method.....	21
3.4 Hierarchical Tree Grouping Method.....	22
<b>CHAPTER 4 : DATA SOURCES AND DATA PROCESSING .....</b>	<b>24</b>
4.1 Data Sources .....	24
4.2 Variables Identification.....	26
4.3 Data Check.....	29
4.4 Database Integration .....	30
<b>CHAPTER 5 : RELATIONSHIP BETWEEN CRASH RISK AND SKID RESISTANCE.....</b>	<b>33</b>
5.1 Crash Rate Ratio .....	33
5.2 CRR-SN Curve Development.....	35



5.3 Skid Number Thresholds Determination .....	37
<b>CHAPTER 6 : NUMERICAL ANALYSIS RESULTS.....</b>	<b>41</b>
6.1 Statewide CRR-SN Curve and Skid Thresholds.....	41
6.2 Hierarchical Tree Chart for Stratified Groups.....	42
<b>CHAPTER 7 : BENEFIT COST ANALYSIS .....</b>	<b>46</b>
<b>CHAPTER 8 : CONCLUSIONS AND RECOMMENDATIONS .....</b>	<b>51</b>
<b>APPENDIX:.....</b>	<b>56</b>
<b>REFERENCES.....</b>	<b>69</b>

## List of Tables

Table 2.1 Investigatory Skid Resistance Levels in U.K. ....	6
Table 2.2 Recommended Minimum Level of Testing for Generic Zones in Australia .....	7
Table 2.3 Investigatory Level of Skid Resistant in Australia .....	8
Table 2.4 QDMR ROAR Investigatory Level of Skid Resistance .....	9
Table 2.5 Correlation between Road Friction and Traffic Safety .....	15
Table 5.1 Suggested actions to be taken for each pavement group .....	39
Table 6.1 Recommended Threshold Values .....	42
Table 6.2 Recommended Skid Thresholds for Stratified Groups .....	45
Table 7.1 Comprehensive Motor Vehicle Crash Cost Estimates.....	46
Table 7.2 Pavement Treatments for Skid Resistance Improvement .....	48
Table 7.3 Benefit Cost Ratios of SN Thresholds for Statewide Crashes.....	48
Table 7.4 Benefit Cost Ratios of Skid Number Thresholds for Statewide Wet Weather related Crashes .....	49
Table 7.5 Recommended Skid Resistance Thresholds for All Weather Crashes .....	50
Table 7.6 Recommended Skid Resistance Thresholds for Wet Weather Crashes.....	50

## List of Figures

Figure 2.1 Generic Zones for Skid Resistance Testing Levels in Australia .....	7
Figure 3.1 Research Conceptual Framework.....	20
Figure 4.1 Demonstration of Route-Milepost System for Integrated database .....	32
Figure 5.1 Distribution of Total Crashes by SN (2008-2011) .....	33
Figure 5.2 Distribution of Lane Miles by SN (2008-2011) .....	33
Figure 5.3 CRR for Skid Number (2008-2011) .....	35
Figure 5.4 CRR-SN Curve Development .....	37
Figure 5.5 Conceptual Illustration of Typical Levels of Skid Resistance .....	39
Figure 6.1 CRR-SN Curve for Statewide crashes.....	41
Figure 6.2 Hierarchical Tree Grouping Structure .....	44

# CHAPTER 1 : INTRODUCTION

## 1.1 Background

In the past five years, over 12,000 fatalities, 48,700 incapacitating injuries, 198,300 non-incapacitating injuries, and 415,900 possible injuries have occurred on the state-maintained highway network in Texas. The Texas Department of Transportation (TxDOT) is responsible for the maintenance of over 195,000 lane miles of highways which substantially consists of pavements designed in 1950s to 1970s that require continuously increasing maintenance needs due to aging infrastructure, high traffic volumes. To make more effective use of the limited maintenance resource, TxDOT has initiated a project to study the potential impact of reduced funding on highway safety. The main objective of this project is to develop a methodological procedure to identify Skid Number(SN)<sup>1</sup> threshold values for highways in the context of traffic crashes, thus to assist TxDOT Administration and engineers in making proper maintenance decisions. These threshold values provide a means for allocating funds to the most needed maintenance projects, in order to ensure the efficient use of scarce resources while managing and preserving the safety of the highway system. In addition, the impact of budget fluctuations on pavement surface maintenance could be significantly reduced.

In this thesis, an exhaustive synthesis of literature addressing the safety implications of roadway surface condition maintenance has been conducted. A methodology is formulated to investigate the statistical correlation between the pavement surface characteristics in terms of skid resistance and crash risks using Texas state maintained system (“on-system”) crash data. Values of pavement skid resistance were obtained from the TxDOT Pavement Management Information System (PMIS); the

---

<sup>1</sup> Skid Number: a measurement of pavement relative skid resistance level.

threshold values of pavement skid resistance were then determined for a substantial portion of the state network and stratified groups of roadway segments by their characteristics, such as different levels of traffic, environmental conditions and road alignments.

## **1.2 Research Scope and Objectives**

The goal of this thesis is to develop a methodological procedure for determining the quantitative relationship between crash rates and pavement surface condition based on skid number values. In addition, guidelines will be provided to assist TxDOT personnel in making critical maintenance decisions regarding threshold values which help determine treatment strategies. Specifically, these guidelines will give TxDOT managers and pavement engineers the ability to identify and address safety related issues, so that they can significantly reduce the impact of budget fluctuations on pavement surface maintenance. This study addresses all types of highways in the state-maintained highway network, or the “on system” network. For comparison purposes separate analyses will be performed using data for all weather crashes and then data only for wet weather crashes to evaluate differences in crash rates for similar Skid Number values. More specifically, the primary objectives of this study are:

- 1) To conduct an exhaustive synthesis of literature regarding impacts of roadway surface maintenance condition on safety. This review will include literature addressing the state-of-the-art and the state-of-the-practice;
- 2) To develop a methodological process and to formulate an experimental design for evaluating the statistical relationships between Skid Number and crash rate based on Texas crash data;

- 3) To develop a procedure for determining critical values of threshold skid resistance for homogeneous groups of road segments stratified by traffic, posted speed limit, and road alignment; and
- 4) To develop a benefit/cost analysis that can be applied to the identified relationships between crash rates and thresholds of Skid Number values in order to assist TxDOT in its maintenance decision-making process.

## CHAPTER 2 : LITERATURE REVIEW

Pavement maintenance budget shortfalls have not been isolated to TxDOT; virtually every U.S. state and many international Transportation Agencies are faced with how to effectively use limited resources to provide safe, reliable, and economical roadways for the travelling public. A state-of-the-practice and state-of-the-art literature review has been performed to identify safety impacts of roadway surface maintenance conditions and reduced maintenance funding.

### 2.1 Management of Skid resistance

Managing skid resistance has been performed in practice by many highway agencies both in the U.S. and in other countries. As part of this study, an extensive literature was conducted to examine these practices in terms of their commonalities and differences. The following sections provide a synthesized summary of these practices.

#### *United Kingdom*

The Highways Agency (HA) in the United Kingdom (U.K.) has developed a policy that establishes friction levels for trunk roads (long distance and heavy traffic roads maintained by HA) by different site categories.

The first suggested level of skid resistance was proposed in late 1950s by Giles (1). However, due to the limitation of technology, the measurement of skid resistance could only be performed for a very short length and was recorded by paper chart. In addition, since Giles realized that it was impractical to set the skid resistance at the same level over the entire network, he suggested setting different standards based on the site categories. In 1973, Salt and Szatkowski introduced the concept of risk rating for different site categories based on crash risk (2). The investigatory standard was carried out in January, 1988 for the U.K. trunk roads. It was determined that at any location on

the network where skid resistance is lower than the investigatory level, an investigation will be required to determine if treatment is needed to improve its skid resistance. As traffic volume increases, revised standards were published in October 2004 and came into practice in 2005 (3, 4).

HA uses the Sideway-force Coefficient Routine Investigation Machine (SCRIM) which has the capability of testing in straight sections, curves and steep grades and providing both the tangential and lateral friction values through curves. Henry and Meyer developed a model to predict sideway-force coefficient (SFC) measured by SCRIM from Locked-Wheel measured Skid Number where SFC is a function of yaw angle  $\alpha$ , zero speed skid number intercept  $SN_0$  and Percent Normalized Gradient ( $PNG$ ) (5).

$$SFC = SN_0[3(\rho^2 - \rho^3) + (1 + 3\rho^2 + 2\rho^3)e^{-\frac{PNG}{100}\left(\frac{V \times \tan(\alpha)}{2}\right)}] \text{ for } \rho > 0 \quad \text{Equation 2.1}$$

$$SFC = SN_0 e^{-\frac{PNG}{100}\left(\frac{V \times \tan(\alpha)}{2}\right)} \text{ for } \rho \leq 0 \quad \text{Equation 2.2}$$

Where,

$$\rho = 1 - \beta\left(\frac{\tan(\alpha)}{3SN_0}\right) \quad \text{Equation 2.3}$$

And

$\beta = 1980 \text{ rad}^{-1}$  for the ASTM E 501 ribbed test tire

Or  $1500 \text{ rad}^{-1}$  for the ASTM E524 blank test tire

$V$  = test speed

$\alpha$  = yaw angle

Table 2.1 shows the skid resistance values identified by the HA for the different road site categories (4).



Table 2.1 Investigatory Skid Resistance Levels in U.K. (3)

Site Category and Definition		Investigatory level (at 50km/h)	
		HD28/94 (preceding)	HD28/04 (current)
A	Motorway	0.35	0.35
B	Dual carriageway non-event	0.35	0.35-0.40
C	Single carriageway non-event	0.40	0.40-0.45
Q	Dual Carriageway (all purpose) - minor junctions	0.40	0.45-0.55
	Single Carriageway minor junctions & approaches to and across major junctions (all limbs)	0.45	
	Approach to roundabout	0.55	
K	Approaches to pedestrian crossings and other high risk situations	0.45	0.50-0.55
R	R Roundabout	0.45	0.45-0.50
G1	G1 Gradient 5-10% longer than 50m	0.45	0.45-0.50
G2	G2 Gradient $\geq 10\%$ longer than 50m	0.50	0.50-0.55
S1	S1 Bend radius <500m – dual carriageway	0.45-0.50	0.45-0.50
S2	S2 Bend radius <500m – single carriageway		0.50-0.55

Table notes: 1. Category R and some sites in new categories S1 and S2 were previously tested at 20 km/h. 2. A reduction in investigatory level of 0.05 is permitted for categories A, B, C, G2 and S2 in low risk situations, such as low traffic levels or where the risks present are well mitigated and a low incidence of accidents has been observed.

*Australia and New Zealand*

A measure similar to the U.K. investigatory level of skid resistance is used in Australia. Since the Australian population is not evenly distributed over the nation, resulting in significant variations in traffic levels and crash risk exposure, different levels of skid resistance test requirements were set based on the friction demand. Figure 2.1 and Table 2.2 show the recommended minimum of skid resistant testing by regions (6).

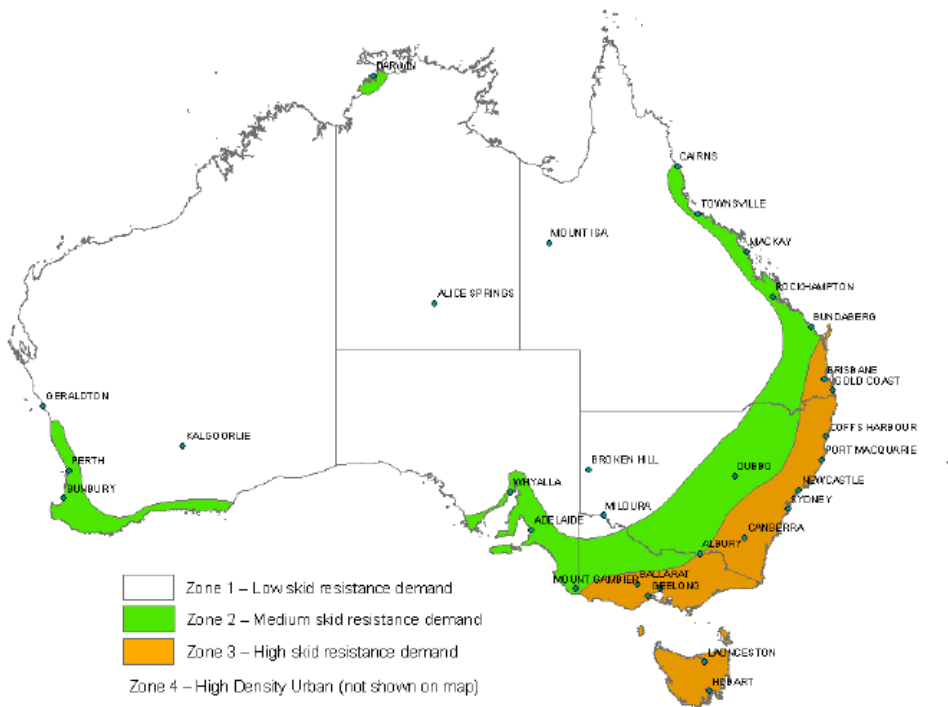

Figure 2.1 Generic Zones for Skid Resistance Testing Levels in Australia (6)

Table 2.2 Recommended Minimum Level of Testing for Generic Zones in Australia (6)

Generic zone	Recommended minimum level of testing
Low skid resistance demand	Process monitoring (e.g. network laser texture surveys or visual analysis as minimum)
Medium skid resistance demand	Targeted testing (e.g. portable and towed devices such as British pendulum, GripTester, ROAR as a minimum)
High Skid resistance demand	Network monitoring (e.g. SCRIM-where cost effective-portable and towed devices as a minimum)
High Density urban	SCRIM or GripTester for inaccessible sites

The investigatory levels of skid resistance are in SCRIM units ( $SFC_{50}$ ), which were originally obtained from early U.K. practice and were adapted for Australian conditions in 1982. However, the climate, traffic volumes and road geometry of Australia are quite different compared to the U.K.; the investigatory level of skid resistance was

then revised in 1996 and incorporated to the Austroads Guidelines in 2003. Table 2.3 shows the current SCRIM investigatory levels (6).

Table 2.3 Investigatory Level of Skid Resistant in Australia (4)

Site category	Site description	Investigatory levels of SFC50 AT 50 KM/H or equivalent						
		0.30	0.35	0.40	0.45	0.50	0.55	0.60
		Corresponding risk ratings						
		1	2	3	4	5	6	7
1 (see notes)	Traffic light controlled intersections Pedestrian/school crossings Railway level crossings Roundabout approaches	Investigation Advised						
2	Curves with tight radius $\leq 250\text{m}$ Gradients $\geq 5\%$ and $\geq 50\text{ m}$ long Freeway/highway on/off ramps							
3 (see notes)	Intersections							
4	Manoeuvre-free areas of undivided roads							
5	Manoeuvre-free areas of divided roads							
Site category	Site description	Investigatory levels of SFC20 AT 50 KM/H or equivalent						
		0.30	0.35	0.40	0.45	0.50	0.55	0.60
		Corresponding risk ratings						
		1	2	3	4	5	6	7
6	Curves with radius $\leq 100\text{ m}$	Investigation Advised						
7	Roundabouts							
<b>key to thresholds at or below which investigation is advised</b>								
		all primary roads, and for secondary roads with more than 2,500 vehicles per lane per day						
		Roads with less than 2,500 vehicles per lane per day						

Notes:

- The difference in sideways force coefficient values between wheel paths (differential friction levels) should be less than 0.10 where the speed limit is over 60 km/h or less than 0.20 where the speed limit is 60 km/h or less.
- Investigatory levels are based on the minimum of the four-point rolling average skid resistance for each 100 m section length
- Investigatory levels for site categories 1 and 3 are based on the minimum of the four-point rolling average skid resistance for the section from 50 m before to 20 m past the feature, or for 50 m approaching a roundabout

For local agencies, modified investigatory levels may be developed. For example, the Queensland Department of Transport and Main Roads (Australia) (QDMR) used the Norsemeter ROAR (Road Analyzer and Recorder) device to measure skid resistance that is expressed in terms of the International Friction Index. QDMR also developed investigatory levels of skid resistance shown in Table 2.4.

Table 2.4 QDMR ROAR Investigatory Level of Skid Resistance (7)

Skid Resistance Demand Category	Description of Site	F60 Investigatory Level		
		40-50 km/h	60-80 km/h	100-110 km/h
High	Curves with radius $\leq 100$ m. Roundabouts. Traffic light controlled intersections. Pedestrian/school crossings. Railway level crossings. Roundabout approaches	0.30	0.35	NA
Intermediate	Curves with radius $\leq 250$ m. Gradients $>5\%$ and $>50$ m long. Freeway and Highway on/off ramps Intersections. Curves with advisory speed $>15$ km/h below speed limit.	0.25	0.30	0.35
Normal	Maneuver - free areas	0.20	0.25	0.30

It was then decided to use SCRIM unit and to adopt RTA/VicRoads criteria including the skid threshold values contained in TD 2004/RS05 (7).

It was stated by the Austroads that since crashes are complex events that cannot be solely explained by the impact of skid resistance there was no existing method to determine the skid resistance threshold that will make a hazardous site “safe” (37).

New Zealand follows the same method in developing its skid resistance policies. In addition to the investigatory level, the threshold was set as 0.1 below the investigatory

skid resistance for each site category where urgent remedial work should be taken. This policy is highly cost effective which resulted in a 20 percent reduction of wet crashes on rural state highways over a 12-year period from 1995 to 2006 (8).

*Federal Highway Administration, U.S.*

There are several mandates by the Federal Highway Administration (FHWA) on the skid safety of pavements, including the Highway Safety Program Standard 12, IM 21-2-73, and T 5040.36 (9). The FHWA's Technical Advisory (T) 5040.17 of December 23, 1980 states that, "the State's program shall provide that there are standards for pavement design and construction with specific provision for high skid resistant qualities."

In NCHRP Synthesis 291 'Evaluation of Pavement Friction Characteristics', a questionnaire was designed to determine the current practices, of evaluating the frictional characteristics of pavements in the U.S. and other countries (10). All 41 states which responded indicated that they performed skid testing on a regular basis along their interstate and primary highway systems. Among these states, 11 have suggested, or formally established "intervention levels" for minimum acceptable skid resistance levels. These states and one territory are Idaho, Illinois, Kentucky, New York, South Carolina, Texas, Utah, Washington, Wyoming and Puerto Rico. For the majority of the 41 states, pavement friction is measured using the American Society of Testing and Materials – International (ASTM) Standard E-274-06, SN40R methodology, which involves obtaining skid numbers using a locked-wheel skid trailer and ribbed tire at a test speed of 40 mph. For pavement maintenance, the suggested thresholds for taking possible maintenance actions are based on the SN40R values range (across different states): from 28 to 41 for Interstates, 25 to 37 for primary roads, and 22 to 37 for secondary roads. For new construction and surface restoration, the minimum friction in terms of the SN40R

requirements ranges from 35 to 45, as reported by Maine, Minnesota, Washington, and Wisconsin.

### *California*

Caltrans maintains a historical friction data set and actively collects friction data as part of its highway monitoring program for the highway network with one test per lane-mile (on average). Caltrans' friction testing method is a locked-wheel towed-trailer tester based on ASTM E 274 requirements for standard ribbed tires. Additionally, in 1972, Caltrans developed the Traffic Accident Surveillance and Analysis System (TASAS) to help identify crash hot spots (locations of high-collision concentration), including a methodology for identifying high-concentration wet crashes locations, known as Wet Table C (9). The Wet Table C is updated on an annual basis and identifies locations with a minimum of 9, 6, or 3 wet crashes within a 36, 24 or 12 month period. For each location identified in Caltrans' Wet Table C, a safety investigation is conducted. Relevant data are gathered and analyzed to identify contributing factors and potential countermeasures. The most effective improvement strategy is then employed using crash details, such as a site's collision history, field investigation, friction test results, a review of the site's geometrics, and additional data elements to investigate crash patterns – such as direction of travel and time of day.

### *Michigan*

The friction testing equipment utilized by MDOT is a Dynatest 1295 (locked wheel) friction tester constructed according to the ASTM E 274 standards. Friction testing is conducted on each lane of all state-maintained roadways on a three-year rotating schedule (approximately one-third of roads are tested each cycle).

It has been approximately 25 years since MDOT began a program to address wet weather crashes. As part of this program, the Safety Programs Section office first

established a list of locations to investigate. Four factors are considered by individual regions for use in the evaluating the identified sites to determine if remedial actions are needed. High crash locations are skid tested between June and September each year (40). Based on the Safety Program the following four factors are used to identify sites: 1) sites with an SN40R value less than 30; 2) sites which are expected to have a reduction of at least 3 wet weather crashes per year if remedial actions are taken; 3) sites with identified factors, such as a clogged drainage structure, which are not related to surface friction qualities but may contribute to a higher percentage of wet crashes; and 4) sites with the time of return on the investment being less than or equal to five years (9).

### *Florida*

The Florida DOT conducts skid testing in the left wheel path based on the ASTM E 274 requirement using a ribbed tire at a test speed of 40 mph. Three tests are usually conducted per mile or section (if less than a mile) for all state roadways on a three-year cycle. The Florida DOT State Materials Office maintains the database of skid test results.

FDOT developed a web-based database application, called the Crash Reduction Analysis System Hub (CRASH), to record and maintain safety improvement projects and update crash reduction factors (19). In addition, the State Safety Office uses Florida's Crash Analysis Reporting (CAR) System to identify wet weather crash locations on the state roadway network. The District Safety Engineers (DSEs) identify the segments by first reviewing the network-level skid test results. The road segments with a speed limit of 45 mph or less are identified if their friction numbers measured by the FN40R are equal to or lower than 28. For the road segments with a speed limit greater than 45 mph, they are identified if their friction number is equal to or lower than 30. For the identified sites, DSEs may investigate the crash records and the sites further to identify potential factors related to crashes to help determine the maintenance activities and schedules (9).

### *New York*

New York established a Skid Accident Reduction Program (SKARP) in the mid-1990s. During April of each year, the Office of Modal Safety and Security identifies locations with high wet crash frequencies and prepares the Priority Investigation Location (PIL) list. The staff in the office of Technical Services will conduct friction testing from April to November for the locations on the PIL list. Friction tests are conducted following ASTM E 274 procedure at 0.1-mile intervals. Locations in PIL are classified into two groups by FN40R using a threshold of 32. All sites with tested result less than 26 require immediate remediation (11).

### *Virginia*

The Virginia Department of Transportation (VDOT) started the Wet Accident Reduction Program (WARP) in early 1970s. Friction tests are conducted at locations with high wet weather related crashes to dry crashes ratio. The skid resistance test uses ASTM E274 trailer unit on a wetted pavement in the speed of 40 miles per hour. Measurements are taken for every 0.1 mile and for sites less than 1 mile, it is expected that measurement should be taken as many as possible, up to one test for every 0.05 mile. Skid number of 20 is an investigatory level below which further investigations are needed for possible remediation (12).

### *Wisconsin*

The Wisconsin Department of Transportation (WisDOT) employs empirical models to determine the friction number (FN). The model used by WisDOT is called the Russell Model and was developed to predict the FN as a function of asphalt material properties, service age of pavement, traffic mix and volume as well as climate variations (14):

$$FN = 41.4 - 0.00075D^2 - 1.45\ln(LAVP) + 0.245(LA WEAR) \quad \text{Equation 2.4}$$



Where,

$FN$  = Friction number calculated at 40 mph

$D$  = Percent dolomite in the asphalt mix

$LAVP$  = Lane Accumulated Vehicle Passes

$LA WEAR$  = Los Angeles Abrasion Test result (ASTM 535-12)

It was suggested that the desirable minimum  $FN$  is 35. The Russell Model does not have the capability to distinguish between factors such as micro and macro-texture. However, there is some consensus that recommends these factors be included in the model (15).

## **2.2 Evaluation of Safety Impact of Skid Resistance**

Roadway crashes are complex events that are resulted from any one or a combination of factors that can be broadly classified as driver, vehicle or pavement condition related factors (16). The highway agency cannot be expected to significantly influence driver and vehicle related factors but has a core responsibility to reduce the influence of pavement condition in crashes. The friction developed between a vehicle's tires and the pavement surface plays a key role in allowing drivers to exercise more control of their vehicles.

A significant amount of research has demonstrated a link between skid resistance and crashes. More specifically, these research efforts have concentrated in the area of wet weather or wet surface crashes. In 2008, there were more than 19,000 fatalities in roadway departure crashes in the United States. Poor roadway conditions, due to inclement weather, especially wet pavement, have been identified as a major contributing factor in this type of crash (10). This has prompted several state DOTs to establish minimum skid resistance values to ensure adequate skid resistance during wet weather

conditions. However, among these states there is no consensus on the minimum value for skid resistance which may be related to variations in terrain, climate including, temperature and precipitation, traffic volumes and other factors. A study by Wallman and Astrom in 2001 identified that increasing pavement friction does result in a reduction in crash rate (34). Table 2.5 provides a summary of the results.

Table 2.5 Correlation between Road Friction and Traffic Safety (34)

Friction Interval	Accident Rate (personal injuries per million vehicle kilometers)
< 0.15	0.8
0.15 - 0.24	0.55
0.25 - 0.34	0.25
0.35 - 0.44	0.2

Further examples of research relating skid resistance and crash rate include: Milton et al. (18) who used crash data from Washington State to calibrate a mixed logit model to estimate the injury-severity distributions of crashes on highway segments. Crashes were divided into three severity categories: property damage only, possible injury, and injury crash. In this study, it was found that increasing pavement friction resulted in a decrease in crash severity. Pardillo (20) used crash data on a 1750-km two-way rural road in Spanish National Road System. Based on friction tests using SCRIM he found that both dry crash rate and wet crash rates decreased as skid resistance increased. In addition, he found that crash rates in curves were significant higher than those of tangent sections. Pardillo suggests  $SFC_{50}$  of 55 and 60 should be set as the threshold of friction for tangents and curves respectively. Using crash and skid resistance data from the Virginia Wet-Accident Reduction Program and from sections without pre-identified crash, Kuttisch (23) concluded that there was a statistically significant effect of skid

resistance on wet-accident rates; more specifically, wet-crash rate increases as the skid number decreases. In the study, the Kuttesch also recommended a target number of 40 as the threshold value to manage skid resistance on Virginia Interstate highways. In the before-and-after study carried out by Miller and Johnson in England, pavement skid resistance was increased from 0.40 to 0.55 which resulted in a significant reduction in both dry surface crashes and wet surface crashes (35). Kamel and Gartshore's study yielded similar results that the improvement of low friction at hazardous spots in Ontario led to a significant reduction of wet weather related crashes (36). Schlosser found that the wet crash per VKT (Vehicle Kilometer Travelled) reduces when skid resistance increased and crash rate is very low at high levels of skid resistance (37).

On the other hand, some researchers concluded that such relationships were not significant, especially for freeways. For example, using data from the entire Swiss national highway network from 1999 to 2003, Lindenmann (24) found that the dataset did not yield any statistical proof of the correlation between pavement skid resistance values and accident frequency on wet freeways.

### **2.3 Management of Skid Resistance in Texas**

TxDOT currently maintains one of the largest databases of pavement performance related information. It collects skid resistance data on approximately 50 percent of Interstate Highways (IH) and 25 percent of the remaining network annually. For non-divided highways the information is collected only in one direction. On divided highways, the information is collected in both directions, typically in the outside lane. Skid data is primarily collected on the main lanes of roadways rather than Frontage Roads due to stop and go conditions and other factors. Network level testing with a skid system is limited to approximately 200 miles of testing per day due to skid tire wear and

time constraints related to periodic refilling of the skid truck water tank. Skid tires are changed on a pre-established cycle to ensure consistency in skid data collection considering tire wear. Skid tires are typically ‘broken in’ by running the tire on the skid trailer a specified distance before actual testing is conducted.

TxDOT uses the locked wheel skid trailer when conducting full scale measurement of skid resistance. This test is specified by ASTM E 274 which is designed to test the frictional properties of a pavement under emergency braking conditions for a vehicle without anti-lock brakes. The test is conducted at a nominal speed of 50 mph with water being applied with an average water film thickness of 0.5mm. The Skid Number is calculated as the ratio of the friction or horizontal force divided by the vertical load of 1085 lbs. ± 15 lbs. as shown by equation below.

TxDOT maintains a fleet of seven skid systems and performs an annual calibration of the fleet as well as daily calibrations conducted on site by district operators to ensure the accuracy and integrity of the information being collected (10, 16).

$$SN(V) = 100\mu = \left(\frac{F}{W}\right) \times 100 \quad \text{Equation 2.5}$$

Where,

$SN$  = skid number

$V$  = Velocity of the test tire, mi/hr.

$\mu$  = Coefficient of friction

$F$  = Tractive horizontal force applied to the tire, lb.

$W$  = Vertical load applied to the tire, lb.

In addition, TxDOT has implemented several other methods for managing skid resistance on its highways. The Department has initiated University research and has conducted extensive in-house research to evaluate relationships between SN values based and aggregate properties including polishing, aggregate source and aggregate type.

Furthermore, TxDOT has implemented the Wet Surface Crash Reduction Program (WSCRCP). The objective of this program is to evaluate friction demand based on route geometry, traffic volumes, number of drives and intersections, annual rain fall, crashes and other factors with respect to friction supply. In this case, friction supply is related to the quality of the aggregate and surface course type including asphalt concrete pavement or seal cost texture properties and other factors.

McCullough and Hankins suggested minimum desirable skid resistance of 0.31 and 0.24 at 20 mph and 50 mph for Texas highways (38). The selection of these thresholds was based on the wet crash rate versus skid resistance curve. However, Henry suggested that there was no relationship can be developed for crash frequency by skid resistance alone since lots of factors have influence on crashes (10).

In summary, the approaches employed by the DOTs (to reduce wet weather crashes) have focused on the identification of high-potential wet crash locations, friction tests on a regular basis, and treatment actions based on different treatment schedules. However, currently there is not any quantifiable relationship between skid resistance and crash data that can be used to determine thresholds for network screening or to assist TxDOT in prioritizing pavement maintenance activities. Therefore, this study seeks to develop such quantitative relationships between safety and skid resistance based on available crash data in Texas and other contributing factors such as, roadway geometries, traffic, and environmental conditions. A methodological framework was developed to establish relationships between safety and road (surface) conditions in order to assist TxDOT in its maintenance decision-making process. The methodological framework is discussed in detail in the next chapter.

## **CHAPTER 3 : METHODOLOGY**

### **3.1 Research Objective**

One of the objectives of this study is to quantify the statistical relationship between pavement skid resistance and crash risk. In addition, critical skid resistant levels will be determined for targeted roadway groups which stratified by traffic levels and roadway alignment features. Finally, a benefit cost analysis will be performed to evaluate the efficiency of the results.

As indicated in the literature, low skid resistance levels can be a significant factor in wet weather related crashes. For this study, an investigation of the correlation of skid resistance and crashes for all types of weather conditions and crashes that occur during wet weather conditions will be analyzed independently.

### **3.2 Conceptual Framework**

In this section, a conceptual framework has been developed to show the various components of the entire process of quantifying the relationship between safety and roadway surface conditions and further determining the critical levels of the roadway surface conditions in terms of skid resistance. Figure 3.1 presents the conceptual framework for this research.

In this conceptual framework, four steps were planned to achieve the research objectives: 1) Process data; 2) Quantify statistical relationships between crash occurrence and skid resistance; 3) Define critical skid resistance levels; 4) Conduct a benefit cost analysis.

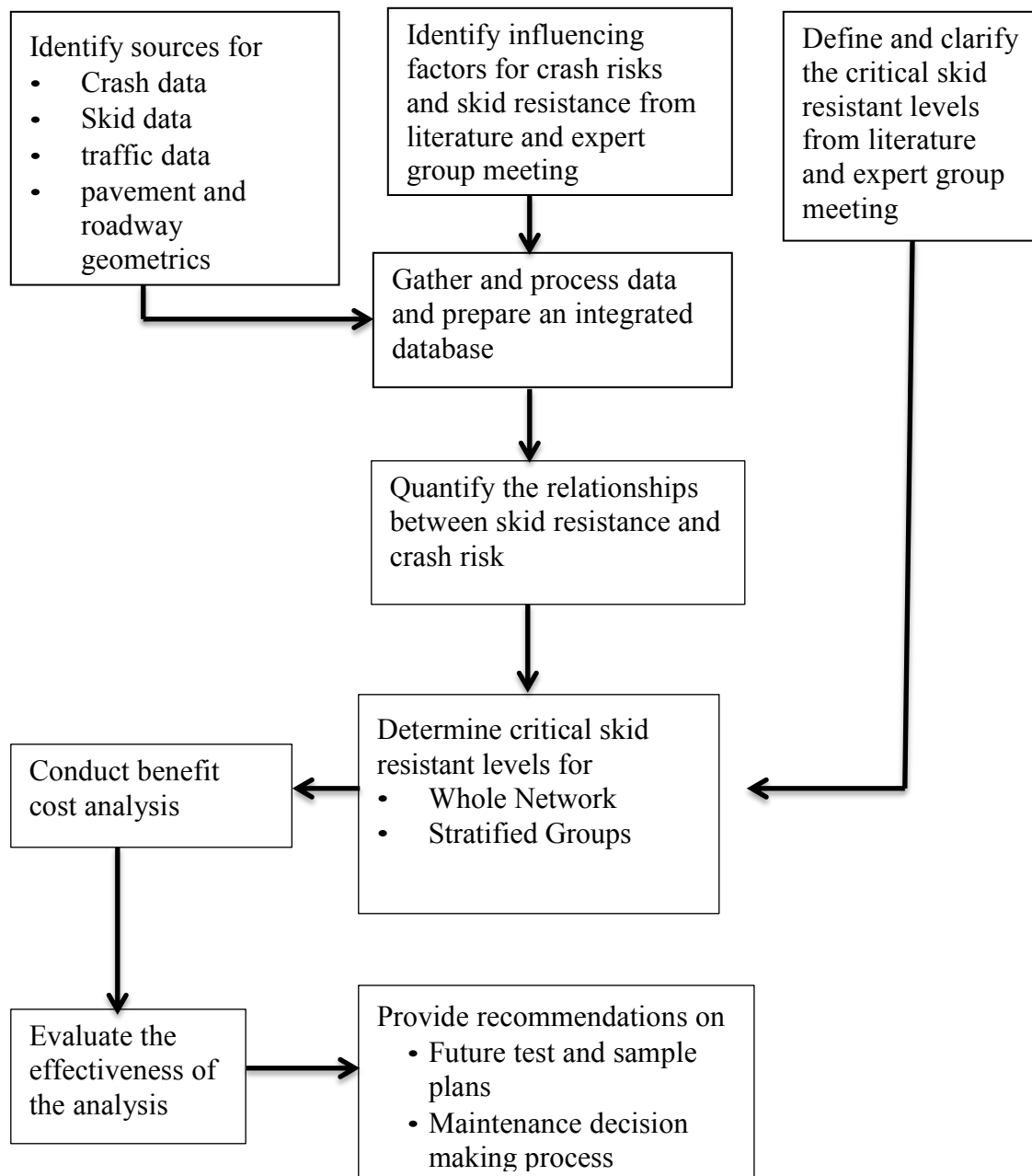

Figure 3.1 Research Conceptual Framework

### 3.3 Crash Rate Ratio Method

Traditionally, crash analyses were focused on establishing a general relationship between crashes and the assumed contributing factors using statistical regression models. For instances, using data from 1994 to 1998, Seiler-Scherer (41) conducted regression analyses to establish the correlation between skid resistance and crash frequency, however, no quantifiable correlation was found. Cenek and Davis (42) used Poisson regression modeling to identify contributing variables relationship with crashes using New Zealand's data from 1997 to 2003. In this study, Cenek and Davis found that the crash rate increases as the skid resistance decreases. Piyatrapoomi and Weligamage (43) used Queensland data from 2003 to 2005 to establish a regression model to predict relationship between crash risks and skid resistance, however, the result showed that the  $R^2$  is too low. Kuttesch (23) used linear regression model and found the skid resistance has a significant impact on wet crash rate. Preliminary regression analyses were performed using both the negative binomial regression and the quantile regression models which considered possible attributes including highway geometry, traffic, and pavement condition information. The results showed that skid resistance, represented by the ASTM Skid Number (SN), has a significant contributing effect on both crash frequency and crash rate. However, because the regression results contain the contributions of all crash related factors it has been difficult to quantify the direct impact of skid resistance on crash risk. The confounding of skid resistance and other crash related factors, has made implementation of skid resistance thresholds difficult in practice. Consequently, a new approach of quantifying the relationship between crashes and skid resistance is explored in this Thesis.



In this approach study, the Crash Rate Ratio (CRR) was proposed as an effective approach to determining the impact of pavement skid resistance on crash risks. More specifically, the CRR is expressed as:

$$CRR = \frac{P_{CR}^{SN}}{P_{LM}^{SN}} \quad \text{Equation 3.1}$$

Where,

$CRR$  = Crash Rate Ratio

$P_{CR}^{SN}$  = Cumulative percentage of total crashes below a specific skid number SN

$P_{LM}^{SN}$  = Cumulative percentage of total lane miles at or below a specific skid number SN

The formulation of CRR is based on the concept of proportion; more specifically, if skid resistance plays no role in traffic crashes, a certain percentage of traffic crashes should be corresponding to a similar percentage of the network in lane miles. Based on this concept, in the case that SN is not correlated to crash occurrence, CRR will be a random number with the mean of 1, regardless the value of SN. If SN is a negative contributing factor to crash occurrence, CRR will increase as the skid resistance declines. In other words, the larger the ratio, the higher the potential safety risks resulted from reducing the Skid Number. Taking SN of 35 as an example, assume there are 30 percent of total lane miles in a network with SN less than 35, CRR is calculated to be 2 according to crash records and skid data. The CRR value of 2 indicates that 60 percent ( $30\% \times 2 = 60\%$ ) of total crashes occurred on 30 percent of highway lane miles.

### 3.4 Hierarchical Tree Grouping Method

Instead of applying the statewide relationship between skid resistance and crashes to every roadway segment, a grouping method was used to categorize the network into

homogenous groups, where highway sections within the same group have similar characteristics in terms of variables being considered such as geometry, traffic, and speed, so that the results will be more representative and applicable to each group. Two grouping methods were considered: K-means clustering and Hierarchical tree grouping; however, the interpretation of the mean for each group is complicated for the K-means clustering, making the implementation of results difficult. In contrast, the hierarchical tree chart is more straightforward and easy for implementation in practice.

To determine the grouping criteria, a preliminary regression analysis of the data was performed to identify variables or attributes that have significant impact on the crash rate. Then, thresholds for each grouping factor were selected and tested to ensure sufficient data are available for analysis within each group.

The hierarchical tree grouping method used in this study is a heuristic method that requires trial and error to finalize the grouping criteria. To perform the procedure, various stratifications of the data based on climatic region, road functional class, AADT, curve type, posted speed limit, rural or urban region, and subgroups of some of them were explored.

In summary, a methodology framework was developed to support this analysis. The CRR method was proposed as a new approach to directly quantify the relationship between crash risk and levels of skid resistance. In addition, hierarchical tree grouping method was selected in support of providing more representative and applicable results to roadway sections with different characteristics. Following the conceptual framework, the data processing procedure will be discussed in Chapter 4.

## **CHAPTER 4 : DATA SOURCES AND DATA PROCESSING**

This chapter discusses the process of preparing a comprehensive database in support of this study which includes four steps: 1) investigation of available data sources that contain information to support analysis, 2) identification of variables that could potentially contribute to safety analysis from the available data sources, 3) examination of data completeness, accuracy and consistency, 4) establishment of a linkage to integrate multiple databases using a linear referencing method.

### **4.1 Data Sources**

Traffic crashes are complex events that are resulted from a combination of driver related, vehicle-related and highway-related factors. In order to support a safety study, several types of data are normally needed, namely crash data (which contains driver, vehicle, weather and other crash related information), pavement condition data, roadway inventory data and traffic data. TxDOT has most of these data items collected and well maintained in several data files, including Crash Record Information System (CRIS), Pavement Management Information System (PMIS), Road-Highway Inventory Network (RHiNo) and, Geometric-Highway Inventory Network (Geo-HINI). A brief introduction to each of the four data sources is given as follows.

#### *CRIS*

TxDOT maintains a statewide CRIS database for all reported motor vehicle traffic crashes received from law enforcement agencies on both the state-maintained and off-system roadways. The TxDOT Traffic Operations Division (TRF) is responsible for the management and maintenance of the CRIS database. The CRIS database is updated and made available to TxDOT and other authorized users continuously (26). The data obtained for this study contains detailed crash information for the period 2008 to 2011.

The CRIS data sets are stored in a text file format and sub-divided into five separate files, namely crash data, vehicle data, personal identification data, lookup data, and citation data. For this study, only the crash data were used. No information regarding personal identification, vehicle type or citations were of interest, or use, in this study.

#### *PMIS*

The TxDOT PMIS database is the primary source of information on state maintained network-level pavement conditions and is maintained by the Maintenance Division (MNT). PMIS has been in use for over 19 years, and was preceded by the Pavement Evaluation System (PES) which was implemented in the early 1980s. The PMIS pavement data are collected annually on a 100 percent roadbed sample of the 195,000 lane-mile, state-maintained highway system. The majority of the attributes are updated annually; the only exceptions being sections of roadway under construction or otherwise unavailable for visual inspection or automated data collection. The mainframe PMIS database is massive and contains location, inventory, roadbed, traffic, distress, ride, and skid data (27). Several of these data items, such as inventory and location data is obtained through an annual upload of data from other TxDOT databases such the Transportation Planning and Programming Division TP&P ‘Texas Reference Marker’ (TRM) database.

#### *RHiNo*

The RHiNo database is maintained and updated by the TxDOT TP&P division. RHiNo contains the statewide roadway network information, geospatial information, and attribute data that are linked to each road segment. There are over one hundred data fields that include lane width, shoulder and median geometry, road function class, traffic volume data, speed limit, truck percentage and many others.

### *Geo-HINI Database*

The Geo-HINI database, being part of the TRM database, is also maintained and updated by TP&P Division (28). Geo-HINI contains geometric information for all horizontal curves, based on the centerline alignment, of all state maintained highways. Each curve is given a unique curve identifier number and described as point data. The Geo-HINI database classifies curves into three types, based on the number of points required to define the curve, including: a) A 'Point Curve' which actually is a small change in the linear alignment at a single point and does not incorporate an actual curve; b) A 'Normal Curve' which is defined by two points including Point of Curvature (PC) and Point of Tangency (PT); c) Spiral Curve which is stored as three or four points: point of change from Tangent to Spiral (TS), point of change from Spiral to Circle (SC), point of change from Circle to Spiral (CS), and point of change from Spiral to Tangent (ST).

## **4.2 Variables Identification**

Since a large amount of information is contained in each of the datasets described earlier, determining the potential contributing factors to a crash at a given location requires that the roadways are segmented by the characteristic values of these factors such that each segment would be distinctive in terms of the contributing factors. This is done by refining selection of variables that have been found to be a contributing factor related to crashes. Some of the variables that have been evaluated are briefly discussed as follows:

### *Crash Information*

The CRIS database contains crash information that is mainly extracted from police reports, including data/time, location, severity, type, contributing factors to the crash, most harmful event, the number of persons involved in the crash, death/injury

count, whether the crash was related to a work zone, whether a commercial motor vehicle is involved, and whether a school bus is involved. Such information not only provides the background on major contributing factors related to the crash identified by the investigating officer, but also can be utilized to analyze crashes by their location, type and severity.

#### *Driver Behavior Information*

Variables related to driver behavior, including driver age, gender, injury severity, alcohol and drug test result, are stored in the CRIS database. Specifically, for bicycle and motorcycle related crashes, whether drivers wore helmets or not are recorded. Driver's information is critical for analyzing on factors related to crashes and developing drivers' demographic statistics in crashes. Although of interest, variables related to driver behavior were not included in this study, but could be considered in future efforts.

#### *Vehicle Information*

Vehicle information includes, but not limited to, vehicle year, body style (e.g., car, SUV, truck), defects, and damage severity. The vehicles conditions have an impact on drivers driving safety. Poorly maintained vehicles could contribute to crashes. The CRIS database is the main source for this information. As with driver behavior, vehicle information was not included in this study, but could be considered in future studies.

#### *Roadway Information*

There are three groups of roadway information that is important to safety analysis: roadway design information, geometric parameters and pavement conditions. Such information is available in the PMIS database.

Roadway information includes but is not limited to highway ID, location reference information (such as reference markers, and Distance From Origin, or DFOs), highway type, pavement surface type, rural/urban designation and post speed limit

(maximum/minimum). For example, the highway type includes Interstate Highways (IH), United States numbered Highways (US), State Highway (SH), Farm to Market roads (FM) and others; different highway types often lead to the use of different design criteria. Design criteria, typically published by the American Association of State Highway and Transportation Officials (AASHTO) and by TxDOT, provide guidance for designing roadway design elements, such as degree of curvatures and curve lengths for horizontal curves.

Geometric parameters include lane width, number of lanes, shoulder width (inside/outside), and median width. Specifically for curved roadway sections, the length and degree of horizontal curves are of importance. To illustrate the geometric parameters impact on drivers driving behavior, shoulder width and number of lanes are presented as examples. Paved shoulders provide lateral support for pavement lanes; narrow shoulders could help reduce pavement edge failures that might be related to crashes.

Pavement conditions include the maintained conditions for current roadway sections. For instance, the general pavement conditions are described through distress score, condition score, skid score, and individual distress types and extents for asphalt concrete, surface treated and Portland Cement Concrete pavements.

#### *Traffic Information*

Traffic information includes AADT and truck AADT percentage (which can be used to compute number of trucks), which is contained in the PMIS, RHiNo and Geo-HINI databases. Trucks can have visual impacts on other driver's field of view when performing steering or braking including lane changes, passing other vehicles and entering or exiting a freeway. Heavy vehicles also have different operating characteristics when accelerating or braking and off-tracking through curves. The presence of heavy

trucks might affect the driving behaviors of light duty vehicle vehicles regarding operating speed and other behaviors.

#### *Other Information*

There are other variables which also have significant impact on safety, such as weather factors, terrain type and bridges. Most of such information is contained in the CRIS database. For examples, regarding the factor “rolling terrain”, the change in grade and vertical alignment may affect driving speed and raise the challenge in maintaining a constant speed.

### **4.3 Data Check**

Before integrating data from multiple sources, including PMIS, CRIS, RHiNo and Geo-HINI datasets, data reliability, completeness and consistency were checked. To check reliability, data was investigated to ensure that data values were within a reasonable range. For example, pavement condition scores range from 1 to 100; any value that does not fall within this range is categorized as data-missing. To check data completeness, the missing percentage of data and information for each required item in each data file was investigated. The percentage of available data was also recorded. For instance, the network-level skid testing is performed on an annual basis. Between May and August of each year, skid tests are conducted along pre-determined routes on each 0.5 mile PMIS section with one skid test performed per section. In this study, approximately 35 percent of PMIS data sections have current skid scores each year. To check consistency, selected data items available from multiple data sources were compared, using statistics to describe and quantify the differences. Inconsistent data records were removed from the integrated database. Generally, this process showed that



the data contained in the four data sources are consistent and of good quality, based on cross-checks that were conducted.

#### **4.4 Database Integration**

The four data sources, namely PMIS, Geo-HINI, RHiNo and CRIS, were originally designed and developed to serve different management goals for TxDOT; therefore, each database was developed with specific and sometimes unique standards regarding the referencing system used. In order to create a comprehensive database, the four data sources had to be integrated based on a single referencing system to ensure proper spatial relationships of crashes, skid data, geometric and traffic features. Data integration is only feasible if these data sources share the same referencing system so that information from different sources can be correctly linked. Understanding the definition of each referencing system and how they are employed for each data source is extremely important for identifying the appropriate data integration approach.

A Linear Referencing System (LRS) is a system that incorporates a technique for identifying the location of a point or a segment along the highway system by retrieving the spatial information stored and maintained in each database. The four target data sources in this study employ the most common referencing systems in Texas which are discussed respectively as following:

In the PMIS database, the identification of the beginning and ending of each data collection section, approximate 0.5-mile long, is based on the TRM. In this system, the Reference Marker Numbers (RMNs) for highways are determined by super-imposing a grid over the map of Texas. All routes, regardless of length must have at least one Reference Marker (RM). Each point or segment can be located by the displacement and direction from the nearest RM.

RHiNo and Geo-HINI files provide location information in multiple referencing systems which include TRM as employed in PMIS, Distance from Origin (DFO), and Control Section and mile point (CSMP). The Control Section referencing system is primarily used for inventory and cost accounting purposes, but has been in use for over 50 years and is a standard reference for both project and network-level applications. The Mile Point within the Control Section further designates an exact location within each control section.

In the CRIS files, the location information for a crash is available in Geographic Coordinate System (GCS). GCS uses latitude and longitude measured by GPS to record the exact location of each crash along the fixed axes on the sphere surface of the earth.

Although TRM has been employed in all the four data sources, it is easier to combine data according to their spatial relations using the DFO referencing system. Therefore, DFO is adopted as referencing system for integration in this research. First, an algorithm process was developed to convert TRM to Route Milepost System (RMS) referencing system. Then, the four data sources were integrated under the DFO referencing system through the linear referencing method (LRM).

Figure 4.1 illustrates the process of integrating multiple databases under the RMS referencing system through the linear referencing method (LRM). As briefly discussed earlier, PMIS, RHiNo, and Geo-HINI data files provide a mixture of fixed length records, variable length features, and point features. Each feature in these three databases is uniform regarding variables associated with it. The integration by LRM further divides highway into shorter uniform sections and combines variables from all three data sources as the attributes of the new generated sections. The CRIS data is then projected on these sections using GPS coordinates.

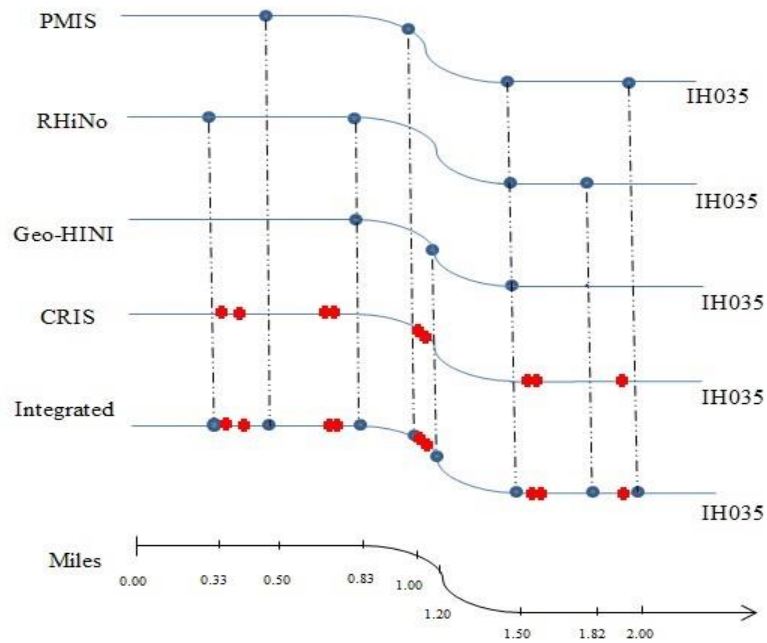

Figure 4.1 Demonstration of Route-Milepost System for Integrated database

In summary, an integrated database was developed in support of this analysis using the identified data sources. The integrated database contains reliable data providing sufficient information for the analysis. In chapter 5, the integrated database will be used to quantify the relationship between crash risk and skid resistance.

# CHAPTER 5 : RELATIONSHIP BETWEEN CRASH RISK AND SKID RESISTANCE

## 5.1 Crash Rate Ratio

As introduced in the methodology, a new approach of quantifying the relationship between crashes and skid resistance has been explored. In this approach, plotted distributions of crashes and road network (in lane miles) with respect to Skid Number were investigated as shown in Figures 5.1 and 5.2, where the 2008-2011 data was used.

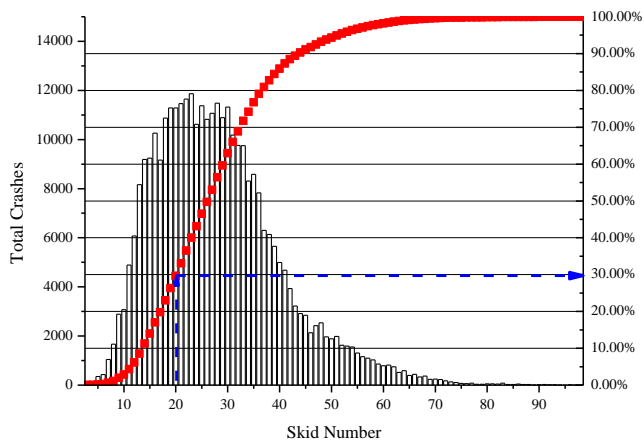

Figure 5.1 Distribution of Total Crashes by SN (2008-2011)

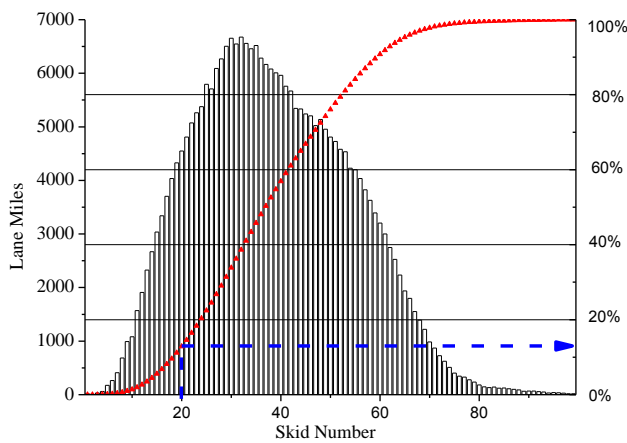

Figure 5.2 Distribution of Lane Miles by SN (2008-2011)

From the two figures, it can be seen that the distribution of the lane miles and that of the skid numbers are not identical, indicating that the cumulated crashes and the corresponding cumulated lane miles are not proportional; in other words, the Skid Number does have an impact on the frequency of crash occurrence. As an illustration of this concept, when the Skid Number is 20 (as marked on the Figure 5.1 and Figure 5.2), the cumulative percentages of total crashes and lane miles are 29.7 percent and 12.8 percent, respectively. This difference in percentages means that 29.7 percent of the crashes occurred on 12.8 percent of the highway lane miles under study. An index, *CRR*, is therefore defined as a measurement of the impact of Skid Number on crash rate: the larger the ratio, the higher the potential safety risk resulted from reducing the skid number.

Referring to Equation 3.1, when the skid number is 20, the calculated *CRR* is 2.31, indicating that the crash rate on a road with a skid number of 20 is 2.31 times of the average crash rate for the entire road network. With *CRR* calculated for each skid number, a quantitative impact of skid resistance on the crash rate could be characterized.

## 5.2 CRR-SN Curve Development

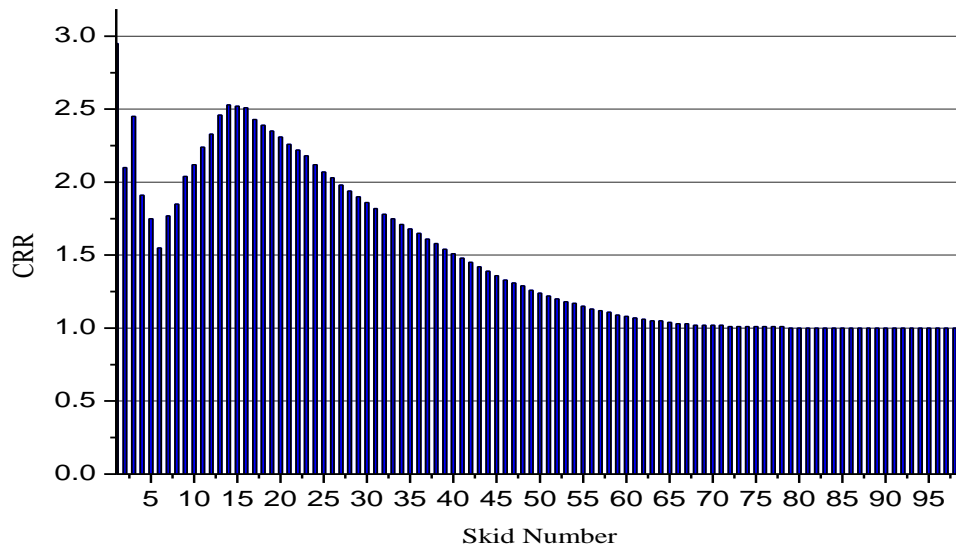

Figure 5.3 CRR for Skid Number (2008-2011)

Based on the CRR concept, Figure 5.3 shows the CRR-SN relation using 2008-2011 data. As it can be seen from Figure 5.3, CRR values decrease as the skid number increases following an exponential trend, indicating that the risk of crashes reduces as the skid resistance increases. It can also be observed from the graphs that such trend is valid for skid numbers greater than 15; however, starting at CRR around 15, the exponential trend takes a reversed turn showing that the CRR decreases as the skid number decreases. According to insights of TxDOT engineers given during an Expert Work Group (EWG) meeting, the primary reason for this phenomenon is that, most TxDOT districts currently start taking actions to address skid problems when the skid number falls below 20, and especially when SN falls below 10 for certain districts with lower quality aggregates. This general treatment results in instability of the curve trend for roadway sections with a Skid Number below 20. This also implies that the CRR values could have been higher for

skid numbers below 15, if no countermeasures were taken for roadway sections that fall into this category.

To eliminate the impact of this countermeasures practice on the relationship between CRR and SN, the theoretical curve development only utilized the effective Skid Numbers that are greater than or equal to 20. Based on the trend of CRR, both a polynomial function and an exponential function can fit the data very well. However, because of the precise fit that can be obtained with high-degree polynomial function, the goodness of fit can rapidly deteriorate as new data are added. On the other hand, exponential curves are more robust when fitting the existing data and as new data are added. An exponential curve has the additional advantage of fitting the CRR trend at high SN values very closely. This helps illustrate the fact that there is little if any improvement in crash rate for higher skid numbers in this region of the curve.

Consequently, exponential relationships between CRR and SN were studied in more detail. The general exponential function between CRR and SN can be expressed as:

$$CRR = a \times e^{-b \times SN50S} + c \quad \text{Equation 5.1}$$

Where,

$a$ ,  $b$ , and  $c$  are constant coefficients

$e$  = base of the natural logarithm

$SN50S$  = Skid Number tested with smooth tire at 50mph

For example, Figure 5.4 shows the development of CRR-SN relationship with Curve Fitting tool in Matlab ©2010a.

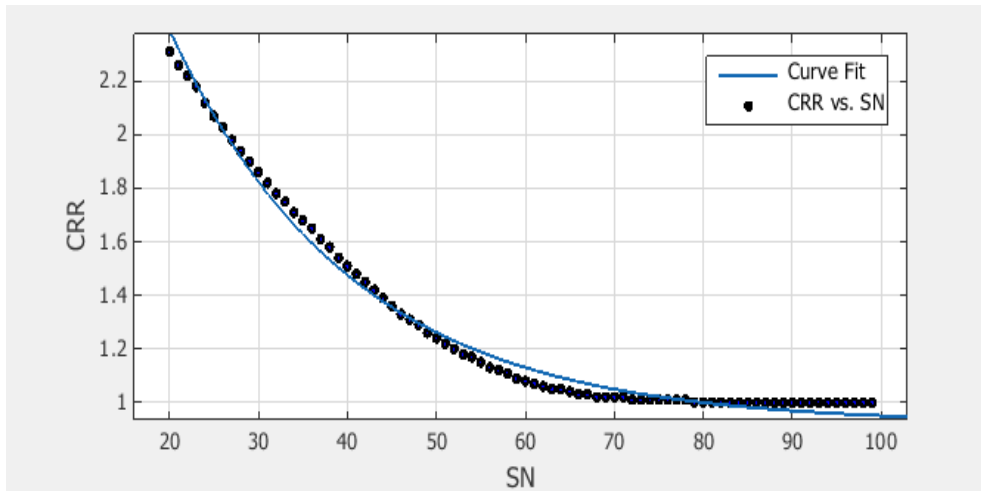

Figure 5.4 CRR-SN Curve Development

With coefficients determined in the curve fitting procedure, the CRR-SN relationship was determined with the following specific expression ( $R^2 = 0.992$ ):

$$CRR = 3.894 \times e^{-0.04605 \times SN50S} + 0.9205 \quad \text{Equation 5.2}$$

Where,

$e$  = base of the natural logarithm

$SN50S$  = Skid Number tested with smooth tire at 50mph

Besides the statistical exponential equation, the theoretical impact of skid resistance on CRR can also be conceptually represented by a CRR-SN curve which will be shown in Chapter 6.

### 5.3 Skid Number Thresholds Determination

With the theoretical relationship of crash risk and skid resistant developed, the critical SN thresholds can be identified by examining the curve characteristics.

The point of inflection method was proposed to identify the minimum required Skid Number value below which CRR would be increasing at a rapid rate with the decrease in Skid Number; for the desirable Skid Number, it is defined as the SN level



above which the impact of increasing SN would have minimal impact on the reduction of CRR, or the point of diminishing return. This approach theoretically has high accuracy of determining critical values; however, defining multiple thresholds for each curve cannot be guaranteed because of the characteristics of the exponential function, where the change rate of CRR to SN is continuously decreasing as Skid Number increases and as a result no inflection point of the curve can be found.

As a result, the Typical CRR method was selected to determine critical threshold values by identifying typical CRRs and then locate their corresponding Skid Numbers. The advantage of this method is that the safety level is taken as the determinative criterion in the selection of Skid Number and multiple thresholds can be identified for each developed curve. Based on guidance from the TxDOT experts who attended the EWG workshop, three break points that divided the curve into four zones were recommended.

The following three break points were suggested by the EWG experts:

- a. No action is needed;
- b. Vigilance is warranted; and
- c. Detailed project-level testing should be conducted to determine if treatments are needed.

Figure 5.5 illustrates the three break points and the actions to be taken for each of the four zones defined by the three break points.

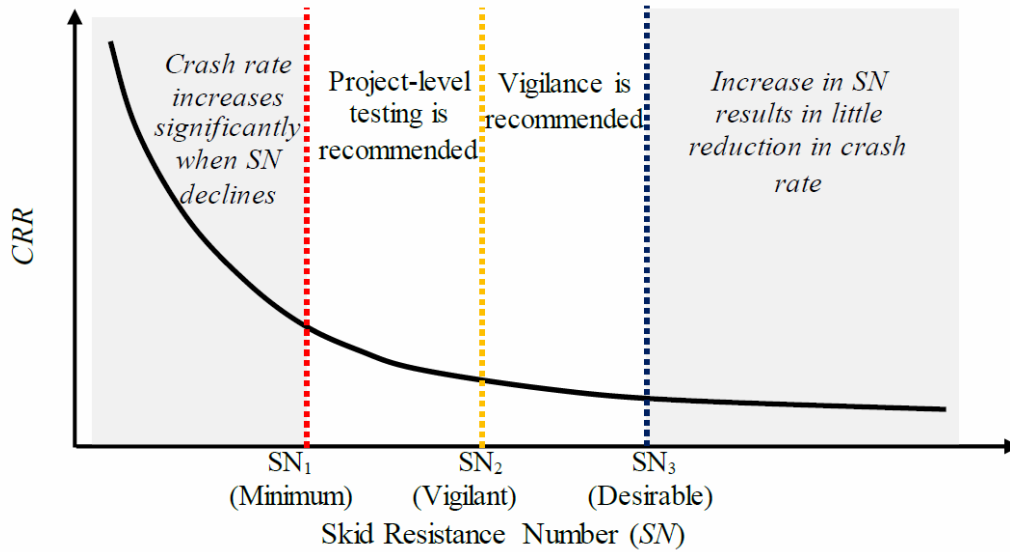

Figure 5.5 Conceptual Illustration of Typical Levels of Skid Resistance

With these identified thresholds, actions are recommended for pavements in each group bounded by these three break points as shown in Table 5.1.

Table 5.1 Suggested actions to be taken for each pavement group

SN Range	Recommended Action
$SN < SN_1$	Potential project for short-term treatment action(s)
$SN_1 < SN \leq SN_2$	Detailed project-level testing recommended
$SN_2 < SN \leq SN_3$	Vigilance Recommended.
$SN > SN_3$	Increased SN may have little effect on reducing crash rates

*SN<sub>1</sub>: Minimum Level of Skid Resistance*

If the SN level is below the minimum acceptable threshold (SN<sub>1</sub>), the risk of crashes increases significantly as SN decreases and therefore pavement maintenance should be carried out to address the problem. SN<sub>1</sub> is recommended as the threshold for

determining whether short-term actions should be taken to improve pavement conditions in terms of skid resistance or not.

*SN<sub>2</sub>: Vigilance Recommended Level of Skid Resistant*

Highway segments with SN between the minimum acceptable threshold and the desirable levels of resistance are suggested as potential action segments. SN<sub>2</sub> further divides them into two categories: a) Detailed project-level testing should be taken to determine if treatments are needed when SN is equal to or less than SN<sub>2</sub>, and b) Vigilance should be warranted when SN is greater than less than SN<sub>2</sub>.

*SN<sub>3</sub>: Desirable Level of Skid Resistance*

The desirable level of skid resistance (SN<sub>3</sub>) is defined as the value where once it is reached, further increase in skid resistance would have yielded little effect on reducing the crash risk; In other words, it can be regarded as the point of diminishing return. If the SN of a road section is equal to or higher than the desirable level, it suggests that the section is well-maintained in terms of pavement friction and no further action is needed to improve the skid resistance from the safety perspective.

## CHAPTER 6 : NUMERICAL ANALYSIS RESULTS

### 6.1 Statewide CRR-SN Curve and Skid Thresholds

With the curve fitting procedure explained in Chapter 5, statistical relationships between CRR and SN can be expressed as an exponential function. In addition, the theoretical impact of skid resistance on CRR can be conceptually represented by a CRR-SN curve. Figure 6.1 shows the CRR-SN curve for all crashes on Texas DOT maintained highways, with the blue solid line representing all crashes and red dash line being for wet weather crashes only.

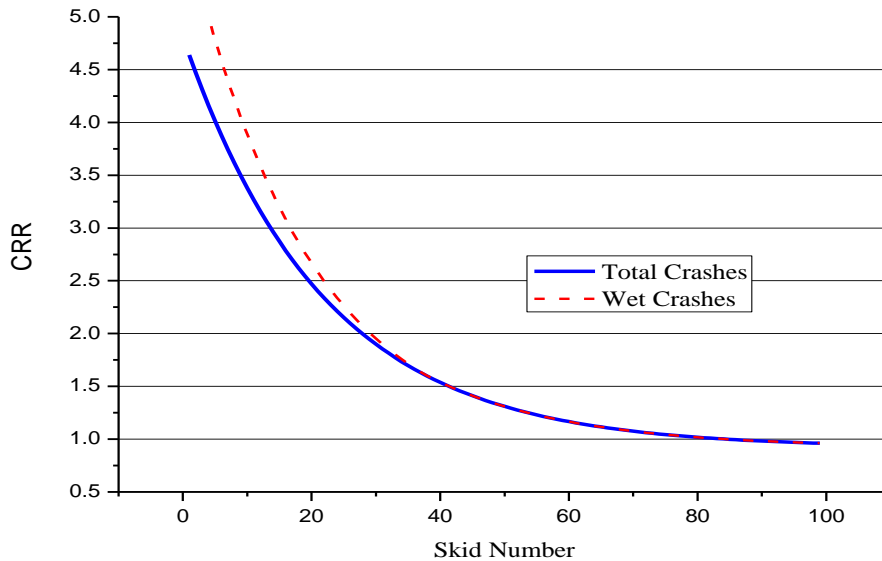

Figure 6.1 CRR-SN Curve for Statewide crashes

CRR-SN for total crashes:

$$CRR = 3.894 \times e^{-0.04605 \times SN50S} + 0.9205 \quad \text{Equation 6.1}$$

CRR-SN for wet crashes:

$$CRR = 5.023 \times e^{-0.05292 \times SN50S} + 0.9264 \quad \text{When } SN50S < 39 \quad \text{Equation 6.2}$$

$$CRR = 3.894 \times e^{-0.04605 \times SN50S} + 0.9205 \quad \text{When } SN50S \geq 39 \quad \text{Equation 6.3}$$

As shown in Figure 6.1, for the same crash numbers, the CRRs for all weather conditions are generally lower than that for wet weather crashes until reaching a relatively high Skid Number. In other words, to maintain the same level of CRR for wet weather crashes, a higher Skid Number should be selected as the threshold.

As discussed in Chapter 5, typical CRR threshold values for CRR suggested by the EWG at the workshop are 3, 2, and 1 (assuming 5% difference, actual value is taken as 1.05) based on the safety level in terms of the crash risks. Theoretically, *CRR* should always equal to 1 if there is no correlation between skid resistance and crashes. If *CRR* is negatively correlated to *SN*, as identified in this study, the lower limit of *CRR* should be 1 when *SN* approaches its upper limit of 99. However, *CRR* cannot exactly be 1 when *SN* equals to 99 because of the variation associated the data. Therefore, 1.05 instead of 1 was chosen as the third typical CRR value. This set of CRR thresholds can be applied to both statewide total crashes and wet weather crashes, yielding different corresponding threshold Skid Numbers. Based on the suggested CRR values, the threshold values in terms of Skid Number were determined in Table 6.1.

Table 6.1 Recommended Threshold Values

Skid Resistance Level	Suggested Threshold Values	
	All weather crashes	Wet weather crashes
SN <sub>1</sub>	14	17
SN <sub>2</sub>	28	29
SN <sub>3</sub>	74	74

## 6.2 Hierarchical Tree Chart for Stratified Groups

A preliminary regression analysis of the data was performed to determine variables or attributes that have significant impact on the crash rate. There are 24 attributes selected for the regression analysis, including traffic information (AADT, speed

limit, truck percent, etc.), geometry characteristics (shoulder width, lane width, number of lanes, etc.), and pavement condition (ride score, distress score, etc.). The following variables are sorted in decreasing significance which include AADT, maximum posted speed limit, median width, median type, shoulder width, number of lanes, rural urban location code, and horizontal curve degree.

Based on the regression analysis conducted and the grouping criteria discussed at the EWG meeting, the research team explored various stratifications of the data based on climatic region, road functional class, AADT, curve type, speed limit, rural or urban region, and subgroups of some of them. After several trials, the hierarchical tree structure was employed to divide all roadway segments into 12 homogeneous groups. The criteria used were speed limit, with or without curve, and AADT per lane.

There were two groups (“low” and “high”) for speed limit with the demarcation line at 55 mph. The low speed limit group contains roadways with a maximum speed limit less than or equal to 55 mph and the high speed limit group includes speeds ranging from 55 to 80 mph. The proportions of “low” and “high” are 43 percent and 57 percent of the roadway sections, respectively.

Within each speed limit group, highway sections were further sub-divided into two groups based on whether the section is in a curve or not. Segments with curves constitute 7.8 percent of the total sections while the rest 92.2 percent is the non-curve segments. As previously stated, network-level skid testing is primarily performed on highway main lanes and therefore does not include ramps, interchange fly overs or other curved roadways that are not considered as main lane pavements.

After the grouping by speed limit and curve, highway sections within each group were further sub-divided into three groups according to the AADT per lane. Since CRR is calculated based on crashes and lane miles, it is important that each group will have

sufficient number of crashes and amount of roadways for analysis. As only 7.8 percent of the network includes curve sections and 11 percent of crashes are wet weather related for the data that was analyzed, the selection of break points for AADT per lane was difficult to determine based on a heuristic approach. The AADT per lane thresholds were eventually set at 2,500 and 4,500 which was further divided into three subgroups. Figure 6.2 shows the hierarchical tree chart for the grouping by the identified factors and their thresholds. CRR-SN curves were developed for each group with the suggested SN thresholds and are included in the Appendix.

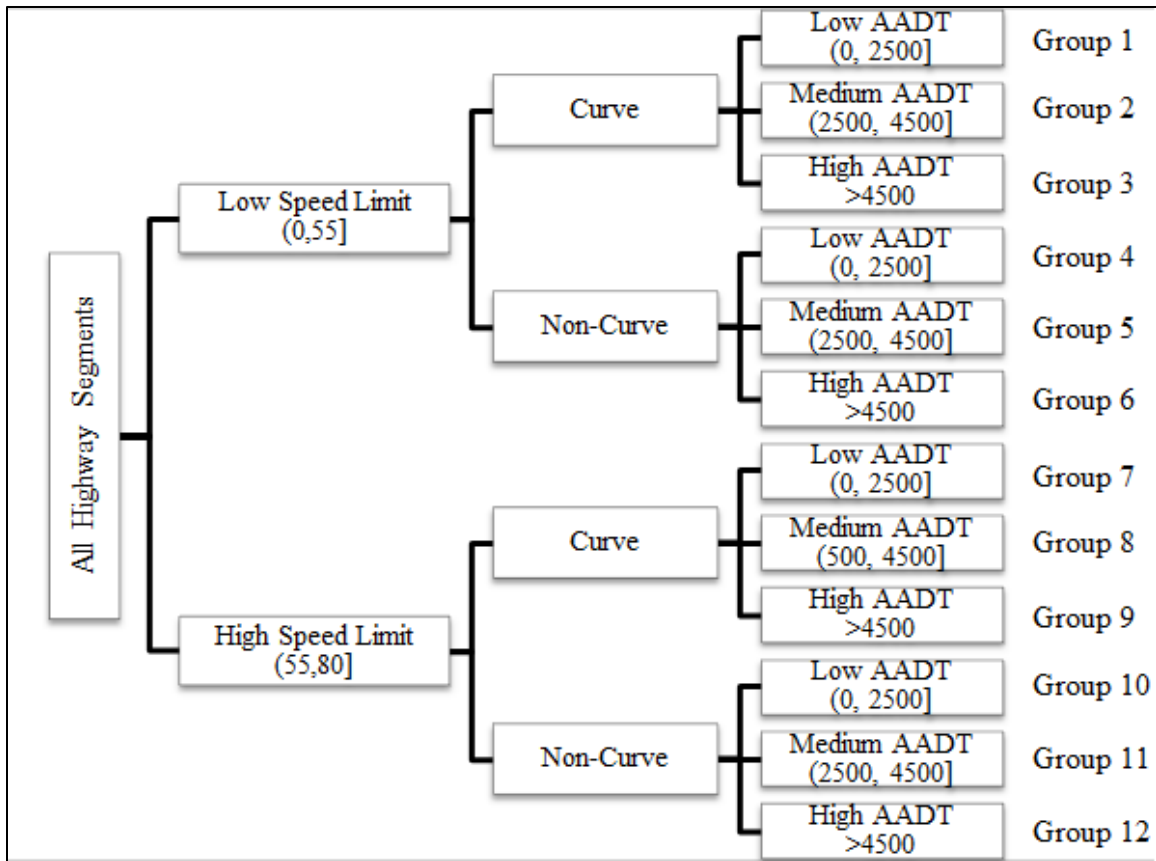

Figure 6.2 Hierarchical Tree Grouping Structure

Table 6.2 summarizes the recommended skid thresholds for each group; due to the limitation of data that not all groups have sufficient number of data points for meaningful regression analysis, some of the recommended thresholds are not available. For these missing thresholds, it is recommended that the corresponding using statewide threshold values be used.

Table 6.2 Recommended Skid Thresholds for Stratified Groups

		Total Crashes			Wet Weather Crashes		
		SN <sub>1</sub>	SN <sub>2</sub>	SN <sub>3</sub>	SN <sub>1</sub>	SN <sub>2</sub>	SN <sub>3</sub>
Statewide		18	24	74	17	29	74
Highway Group ID	1	-	31	61	20	34	64
	2	-	-	57	-	-	61
	3	-	-	54	-	10	54
	4	11	26	63	18	31	64
	5	-	-	56	-	-	58
	6	-	-	54	-	-	56
	7	14	26	50	23	35	57
	8	-	10	43	14	20	48
	9	-	-	50	23	34	52
	10	-	16	41	-	30	51
	11	-	-	39	-	14	49
	12	-	-	50	-	10	51

In this chapter, the numerical analysis result was presented with recommended threshold values for pavement skid resistance. To evaluate and fine-tune the selection of these thresholds, benefit cost analyses were performed and will be discussed in detail in Chapter 7.



## CHAPTER 7 : BENEFIT COST ANALYSIS

In this chapter, benefit-cost analyses were conducted to evaluate and fine-tune the SN thresholds values determined in Chapter 6. To conduct the analysis, the savings in crash costs and the corresponding costs for improving pavement skid were used as the benefit and cost respectively. Savings in crash costs were estimated by the expected reduction in the number of crashes and the average cost per crash; the average cost per crash was based on established values for each level of injury recommended by the National Safety Council (NSC). The unit cost for pavement preventive maintenance was taken as the average cost for improving pavement skid resistance per lane-mile. More specifically, the values based on injury level for each crash recommended by NSC are shown in Table 7.1.

Table 7.1 Comprehensive Motor Vehicle Crash Cost Estimates (29)

Crash Severity	Comprehensive Crash Cost (\$ per person)	Count of persons
Death	4,459,000	8,708
incapacitating Injury	225,100	30,863
Non-incapacitating Injury	57,400	125,560
Possible Injury	27,200	253,211
Property Damage Only	2,400	208,023*
* property damage only counts for number of crashes		

Since it is impossible to predict crash reductions in each of the crash severity levels using the CRR model, the average cost per crash was therefore employed as the basis for calculating the cost savings from crash reductions. Using crash data statistics for Texas the average cost per crash was calculated as:

$$Average\ Crash\ Cost = \frac{\sum_{Injury\ class} unit\ cost * count\ of\ person}{Number\ of\ Crashes} \quad \text{Equation 7.1}$$

With a total number of 322,914 crashes, the average crash cost was determined to be \$190,000.

To estimate the reduction of the number of crashes, the CRR in corresponding to the targeted SN and the statewide total number of crashes were used. An assumption was made that the skid improvement treatment, once applied, will raise the SN to a high level of 75. The annual benefit of skid resistance improvement can therefore be determined with the following formula:

$$Benefit = \frac{(CRR_{targeted\ SN} - 1) \times Average\ Crash\ Rate \left( \frac{crashes}{lanemile} \right) \times Lanemiles(miles) \times Average\ Crash\ Cost(\$ / crash)}{4\ years}$$

Equation 7.2

In Equation 7.2, the average statewide total number of crashes was calculated by dividing the total number of crashes for 2008-2011 with four. Lane-miles value is the size of network (in miles) with Skid Number less than the targeted SN. The average crash rate is 1.232 crashes per lane-mile.

Limited literature was found on the costs of pavement skid resistance improvement. Table 7.2 has listed the cost range and life span for different pavement treatments (30, 31, 32). Instead of using the cost range in this table, the unit cost of preventive maintenance was determined to be used according to the TxDOT 4-Year Management Plan which includes estimated costs for mobilization, traffic control, materials, labor, and ancillary items necessary to complete the pavement project (33). Since most of the roadways are flexible pavements, preventive maintenance cost for flexible pavements (\$29,000 per lane per mile) was estimated as the unit cost.

Table 7.2 Pavement Treatments for Skid Resistance Improvement

Treatments	Estimated Cost (\$/ft <sup>2</sup> )	Estimated Lifetime (years)	SN Improvement
Thin overlay	0.45	9	Yes
Micro-surfacing	0.02-0.54	4-7	Yes
Chip seal	0.2	3-8	Yes
Strip sealing	0.11-0.2	< 3	Yes (temporary)

The treatment service life is estimated to be 10 years with an assumption that SN will not drop significantly during the service life. The total cost per year is calculated as:

$$Cost = \frac{29,000\left(\frac{\$}{miles}\right) \times Lanemiles (miles)}{Service Life (year)} \quad \text{Equation 7.3}$$

Combine Equation 7.2 and 7.3, the benefit cost ratio can be expressed as:

$$\frac{B}{C} = \frac{10years \times Average Crash Rate\left(\frac{crashes}{lanemile}\right) \times 190,000\left(\frac{\$}{Crash}\right) \times (CRR_{targeted SN} - 1)}{4years \times 29,000\left(\frac{\$}{mile}\right)} \quad \text{Equation 7.4}$$

In Chapter 6, the SN thresholds for statewide crashes were determined to be 14, 28, and 74. The benefit cost ratio for each threshold is shown in Table 7.3.

Table 7.3 Benefit Cost Ratios of SN Thresholds for Statewide Crashes

Skid Number thresholds	Benefit Cost Ratio
14	39.64
28	20.04
74	0.99

As it can be seen from Table 7.3, the B/C ratios are very high for the first two SN thresholds while when SN approaches 74, the benefit of pavement skid resistance improvement is diminishing. It was found out that when SN equals 73, the benefit to cost ratio is 1 meaning that beyond this point, the improvement of skid resistance will not gain benefit from crash reduction savings. To fine-tune the selection of SN thresholds, theoretically SN of 14, 28 and 73 should be selected based on the benefit cost analysis.

Assuming all crashes occurred under a wet weather condition, the recommended threshold for wet weather crashes were evaluated. Table 7.4 shows the benefit cost ratios for Skid Number thresholds selected for statewide wet weather related crashes. To fine-tune the selection of threshold value, it was found that when Skid Number equals 73, the benefit equals to the cost.

Table 7.4 Benefit Cost Ratios of Skid Number Thresholds for Statewide Wet Weather related Crashes

Skid Number Thresholds	Benefit Cost Ratio
17	39.64
29	20.04
74	0.99

Table 7.5 and Table 7.6 summarize the fine-tuned thresholds and the corresponding benefit cost ratios. The result showed that the benefit of improving pavement skid resistance is significantly higher than the cost, especially for the thresholds SN<sub>1</sub> and SN<sub>2</sub>.

Table 7.5 Recommended Skid Resistance Thresholds for All Weather Crashes

Before B/C analysis		After B/C analysis	
Skid number thresholds	Benefit cost ratio	Skid number thresholds	Benefit cost ratio
14	39.64	14	39.64
28	20.04	28	20.04
74	0.99	73	1.13

Table 7.6 Recommended Skid Resistance Thresholds for Wet Weather Crashes

Before B/C analysis		After B/C analysis	
Skid number thresholds	Benefit cost ratio	Skid number thresholds	Benefit cost ratio
17	39.64	17	39.64
29	20.04	29	20.04
74	0.99	73	1.13

In summary, based on the benefit cost analysis performed for the determined thresholds, the benefit is significantly larger than the cost until it reaches the third thresholds where B/C ratio is approximately 1.0. Since the benefit cost analysis validated the selection of thresholds, no further adjustment to the threshold values is recommended as a result of benefit cost analysis.

## **CHAPTER 8 : CONCLUSIONS AND RECOMMENDATIONS**

This thesis proposed a methodological framework for quantifying the relationship between crash risks and pavement skid resistance. First, a comprehensive review of the current practice of managing skid resistance to addressing safety concerns was carried out. Then, a comprehensive database was generated from four TxDOT maintained data files in the support of safety research. After that, a hierarchical grouping structure was developed to stratify the entire network into homogeneous groups by traffic level, speed limit and the presence of horizontal curves. Next, the impact of skid resistance on crash rate was established quantitatively with the development of CRR-SN curves for crashes under all weather conditions and under wet weather conditions. Then, critical skid resistance levels were defined and identified for the whole network and each group. Finally, benefit-cost analysis was performed to evaluate the determined threshold values for skid resistance. The proposed methodology enables decision maker to make proper maintenance decisions when there is a budget shortfall so that the efficiency and safety of the highway system could be preserved.

Compared to traditional regression models that are developed to describe the relationship between pavement skid resistance and crash risks, CRR-SN model is specifically designed to support the management of skid resistance at the network level. The development of CRR-SN curves provides both researchers and engineers an easy way to quantify and understand the quantitative relationship between skid resistance and crash risks. By choosing the break points of CRR according to the safety goals and objectives of the transportation agencies, the critical threshold values in terms of SN can be directly determined.

Major conclusions drawn from this study include:

- 1) Based on the data analyzed, skid resistance has a negative impact on crash risk: the crash risk increases when the skid resistance decreases.
- 2) Though data for crash analysis can be diverse and from different data sources, formal procedures can be developed and implemented to integrate the needed data into an effective database in support of the analyses.
- 3) In this research, various general regression models were explored to correlate crash rate with potential variables affecting crash rate; however, because of the nature of the available data, no regression models were able to satisfactorily describe such relationships between the crash risk and the pavement skid resistance.
- 4) The CRR concept developed under this study can overcome the issues associated with the general regression models in achieving the goal of this project, as it can be easily calibrated to provide quantitative relationship between crash risks and skid resistance.
- 5) Based on the developed CRR-SN model, skid resistance thresholds can be determined easily according to the target crash risk level or expected crash reduction. The recommended statewide skid resistance thresholds are 14, 28, 73 for all weather crashes and 17, 29, 73 for wet weather crashes.
- 6) The benefit cost analysis showed that benefit was significantly higher than the cost, especially for the first two thresholds, justifying the recommended threshold values.
- 7) The study yielded results that can be easily implemented by TxDOT in the maintenance decision-making process thus making the allocation of its resources more effectively.

The study has certain limitations that future research may focus on, including:

- 1) Due to limited crash data, especially wet weather crashes, all crash records were used for the development of CRR-SN curve including crashes that may not have direct relationship with pavement conditions. Future research should be carried out to fine-tune the analysis by excluding crashes that are irrelevant to pavement conditions.
- 2) Crash rate is influenced by a number of factors, the grouping criteria was selected based on regression result and then a heuristic approach to maximize the useful data in each of the twelve groups. However, CRR is a function of crashes and number of lane-miles, and there are groups with limited number of crashes, especially wet weather crashes, or amount of roadway network. Further study should be performed with more data or to come up with a fine-tuned grouping structure.
- 3) During the benefit cost analysis, an assumption was made that pavement skid resistance will not deteriorate dramatically over the service life. Further research may be required to address the deterioration rate of skid resistance over time for a more detailed benefit analysis.
- 4) A more detailed crash cost savings estimation should be conducted to include other costs besides the injury costs. These costs could include traffic delays, repair costs to TxDOT property such as guard rail or signs that can occur during a crash and other incident costs.
- 5) Further work should be conducted to consider if this methodology can be applied on a regional basis. TxDOT has sub-divided the State into 5 climatic regions which generally also relate to 4 Management Regions. A more accurate assessment of B/C ratios and Threshold values might be possible considering regional factors.



- 6) In addition, district analyses could be undertaken though reduced total crash and wet weather crash data within a district might be insufficient for the analysis. However, analyses could be performed for major metro districts with very high traffic volumes and for districts with lower average SN values associated with local aggregate sources with higher wear rates.
- 7) Further work could be conducted to develop a web-based system that provides TxDOT Administration, Divisions and Districts with a tool for analyzing total crashes, wet weather crashes and SN values. This analysis tool could also potentially develop graphs or charts showing the cumulative distributions for SN values for each roadway functional class in addition to other methods for managing network conditions.
- 8) Rainfall amounts vary significantly from eastern Texas (60 inches per year) to west Texas (6 inches) per year. In addition, rain fall intensity, duration and time between rainfall events vary significantly statewide. Further work could be conducted to evaluate methods for incorporating annual rain fall amount (currently used in the TxDOT Wet Surface Crash Reduction Program) or percentage of wet pavement time which is used by Caltrans in the Wet Table C analyses.
- 9) Currently, PMIS does not include pavement cross slope as a data item. However, work is underway to investigate the potential for adding cross slope measurements to PMIS based on automated data collection equipment measurements. Future work could address the potential addition of cross slope rate and variations in cross slope along a route as a factor in the analysis.
- 10) TxDOT is exploring the use of texture lasers to measure Mean Profile Depth which can then be used to compute Mean Texture Depth (MTD) based on

ASTM methodology to predict sand patch test results from MPD values. If texture lasers are implemented for network level data collection, MTD rather than SN would be used for network-level screening purposes and the skid system fleet would no longer be used for network-level testing. In this case, skid systems would be reserved for project level testing, crash investigations and forensic investigations initiated by the National Transportation Safety Board. Thus, future work might involve a new analysis of network conditions based on MTD rather than SN.

**APPENDIX:**  
**RESULTS FOR STRATIFIED GROUPS**

A1. Group 1: Low AADT per lane, Low Speed Limit, with Curve

Total Crashes

Wet Weather Crashes

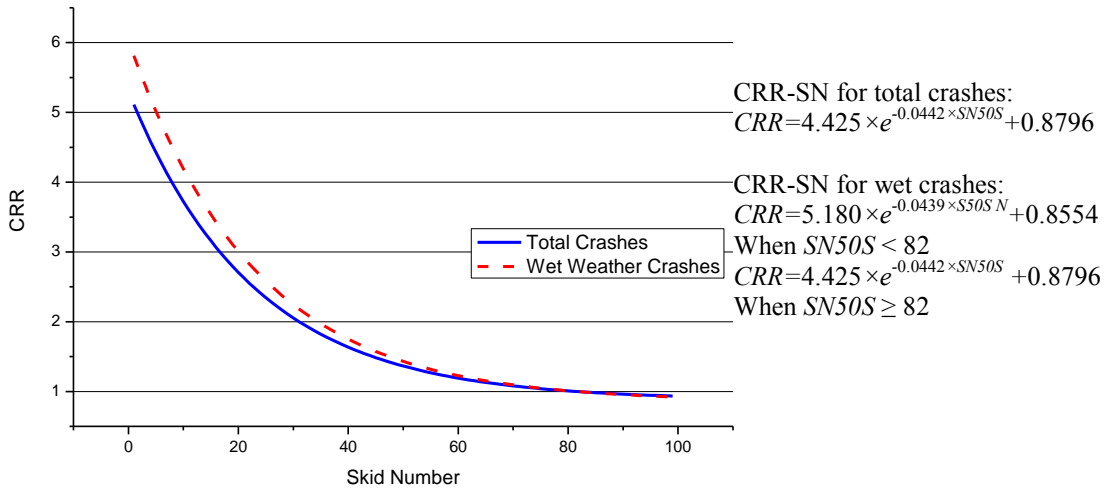
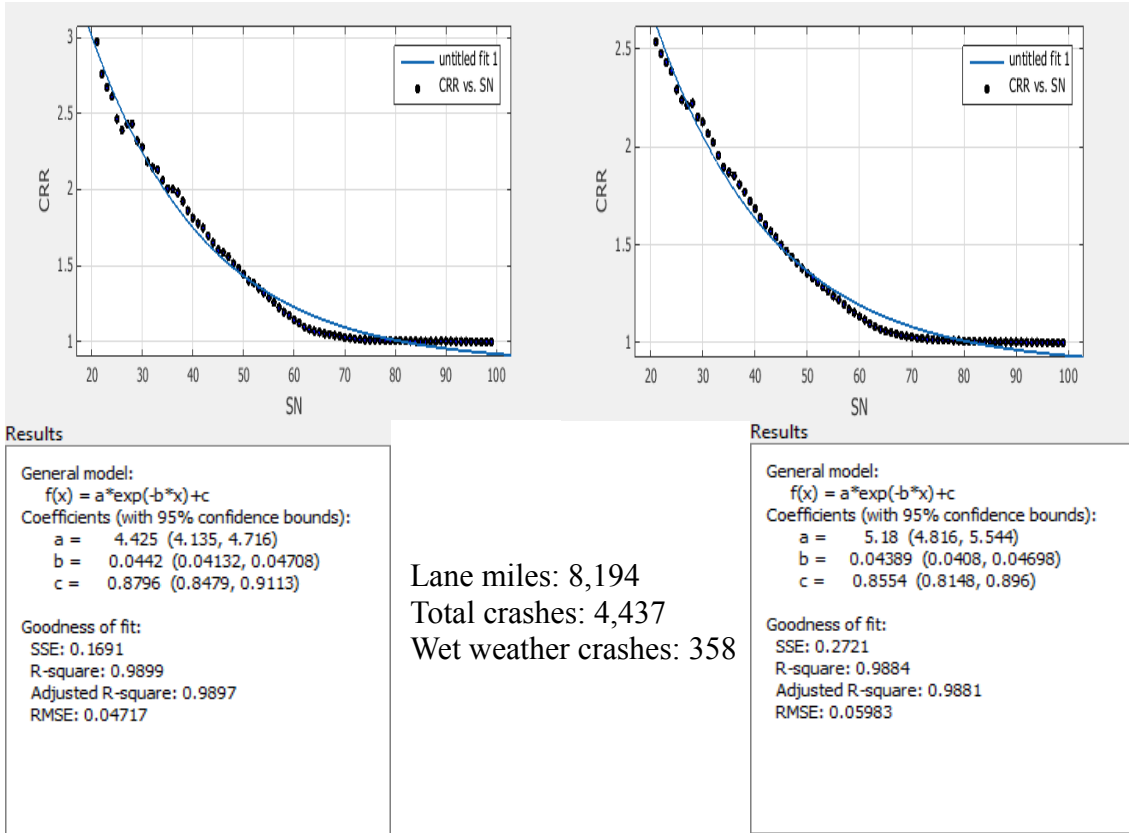

## A2. Group 2: Medium AADT per lane, Low Speed Limit, with Curve

### Total Crashes

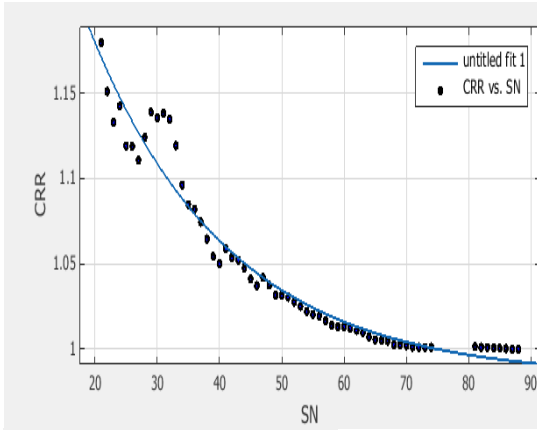

Results

General model:  
 $f(x) = a \cdot \exp(-b \cdot x) + c$   
 Coefficients (with 95% confidence bounds):  
 a = 0.4818 (0.4034, 0.5603)  
 b = 0.04482 (0.03687, 0.05277)  
 c = 0.9832 (0.9722, 0.9942)

Goodness of fit:  
 SSE: 0.007401  
 R-square: 0.9537  
 Adjusted R-square: 0.9521  
 RMSE: 0.0112

### Wet Weather Crashes

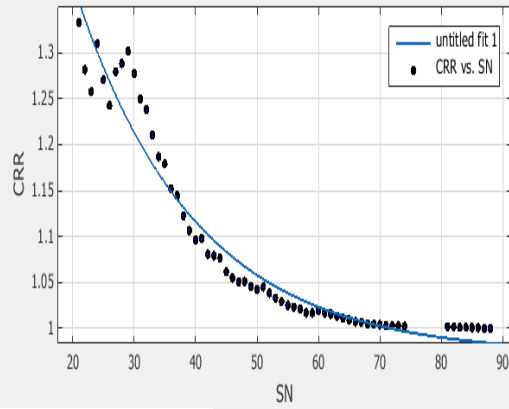

Results

General model:  
 $f(x) = a \cdot \exp(-b \cdot x) + c$   
 Coefficients (with 95% confidence bounds):  
 a = 1.134 (0.916, 1.353)  
 b = 0.05149 (0.04265, 0.06033)  
 c = 0.9715 (0.952, 0.9911)

Goodness of fit:  
 SSE: 0.0347  
 R-square: 0.9491  
 Adjusted R-square: 0.9474  
 RMSE: 0.02425

Lane miles: 1,350  
 Total crashes: 3,954  
 Wet weather crashes: 400

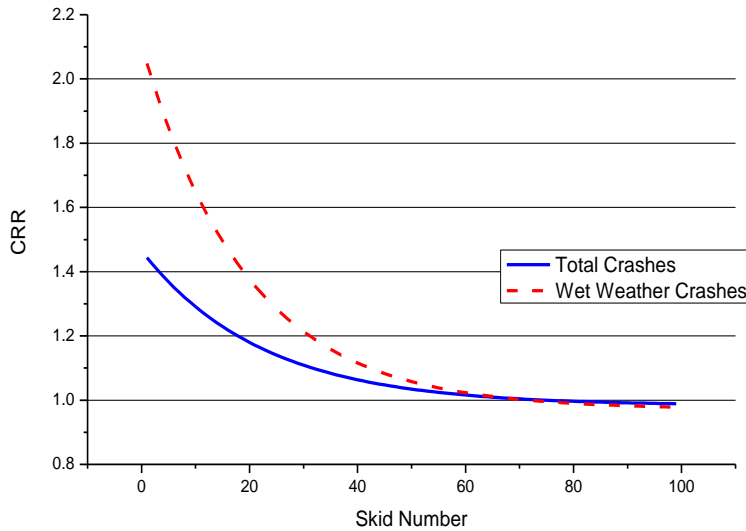

CRR-SN for total crashes:  
 $CRR = 0.482 \times e^{-0.0448 \times SN50S} + 0.9832$

CRR-SN for wet crashes:  
 $CRR = 1.134 \times e^{-0.0515 \times SN50S} + 0.9715$

When  $SN50S < 68$   
 $CRR = 0.482 \times e^{-0.0448 \times SN50S} + 0.9832$   
 When  $SN50S \geq 68$

A3. Group 3: High AADT per lane, Low Speed Limit, with Curve

Total Crashes

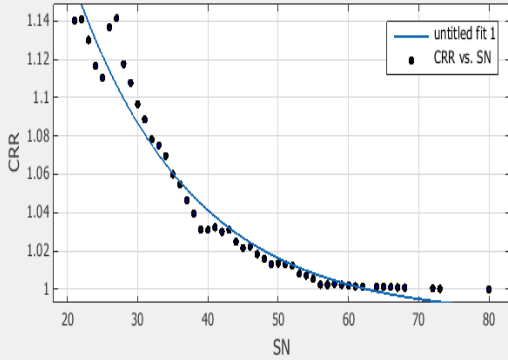

Wet Weather Crashes

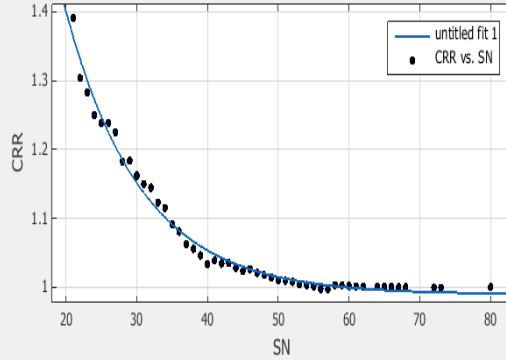

Results

General model:  
 $f(x) = a \cdot \exp(-b \cdot x) + c$   
 Coefficients (with 95% confidence bounds):  
 a = 2.645 (2.204, 3.086)  
 b = 0.0931 (0.08579, 0.1004)  
 c = 0.9894 (0.9828, 0.9959)  
 Goodness of fit:  
 SSE: 0.005864  
 R-square: 0.9879  
 Adjusted R-square: 0.9874  
 RMSE: 0.01117

Lane miles: 1,120  
 Total crashes: 7,007  
 Wet weather crashes: 685

Results

General model:  
 $f(x) = a \cdot \exp(-b \cdot x) + c$   
 Coefficients (with 95% confidence bounds):  
 a = 0.6075 (0.4755, 0.7394)  
 b = 0.05981 (0.04936, 0.07025)  
 c = 0.9856 (0.9761, 0.9952)  
 Goodness of fit:  
 SSE: 0.004182  
 R-square: 0.962  
 Adjusted R-square: 0.9603  
 RMSE: 0.009433

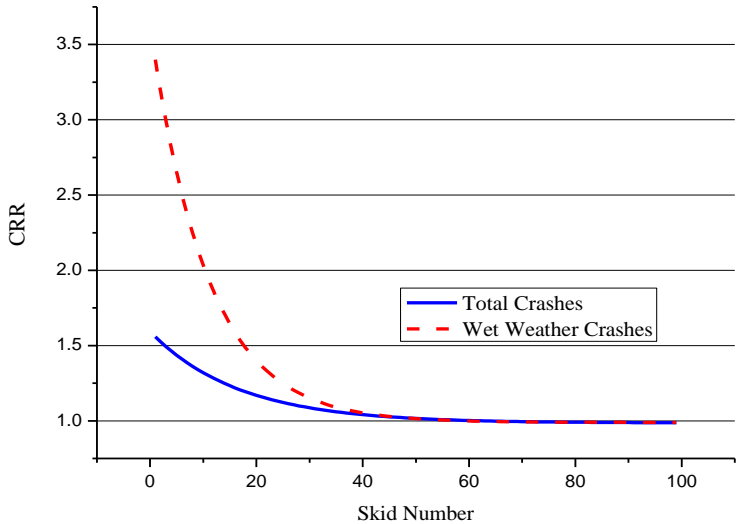

CRR-SN for total crashes:  
 $CRR = 2.645 \times e^{-0.0931 \times SN50S} + 0.9894$

CRR-SN for wet crashes:  
 $CRR = 0.608 \times e^{-0.0598 \times SN50S} + 0.9856$

When  $SN50S < 77$   
 $CRR = 2.645 \times e^{-0.0931 \times SN50S} + 0.9894$   
 When  $SN50S \geq 77$

A4. Group 4: Low AADT per lane, Low Speed Limit, without Curve

Total Crashes

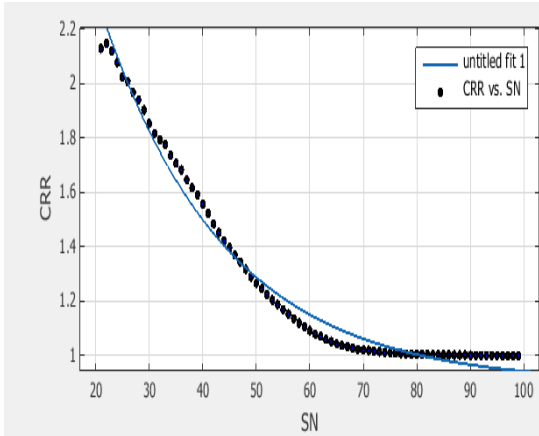

Results

General model:  
 $f(x) = a \cdot \exp(-b \cdot x) + c$   
 Coefficients (with 95% confidence bounds):  
 a = 4.983 (4.645, 5.321)  
 b = 0.04875 (0.04587, 0.05164)  
 c = 0.9006 (0.8734, 0.9278)

Goodness of fit:  
 SSE: 0.162  
 R-square: 0.9907  
 Adjusted R-square: 0.9905  
 RMSE: 0.04618

Wet Weather Crashes

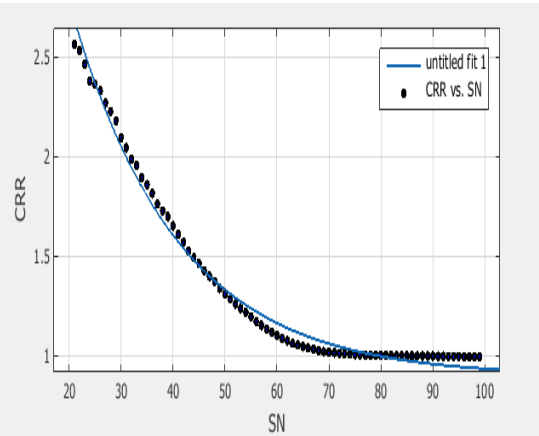

Results

General model:  
 $f(x) = a \cdot \exp(-b \cdot x) + c$   
 Coefficients (with 95% confidence bounds):  
 a = 3.4 (3.138, 3.663)  
 b = 0.0433 (0.03989, 0.04672)  
 c = 0.8974 (0.8668, 0.9279)

Goodness of fit:  
 SSE: 0.1483  
 R-square: 0.9857  
 Adjusted R-square: 0.9853  
 RMSE: 0.04417

Lane miles: 72,500  
 Total crashes: 37,351  
 Wet weather crashes: 3,278

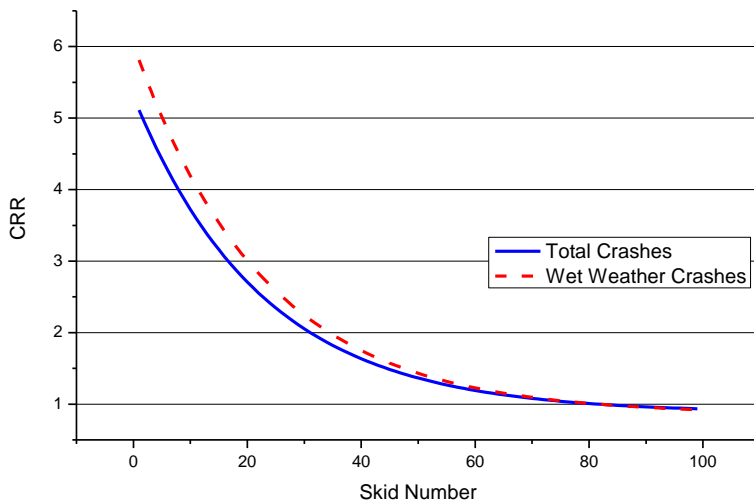

CRR-SN for total crashes:  
 $CRR = 4.983 \times e^{-0.0488 \times SN50S} + 0.9006$

CRR-SN for wet crashes:  
 $CRR = 3.400 \times e^{-0.0433 \times SN50S} + 0.8974$

When  $SN50S < 75$   
 $CRR = 4.425 \times e^{-0.0442 \times SN50S} + 0.9006$   
 When  $SN50S \geq 75$

A5. Group5: Medium AADT per lane, Low Speed Limit, without Curve

Total Crashes

Wet Weather Crashes

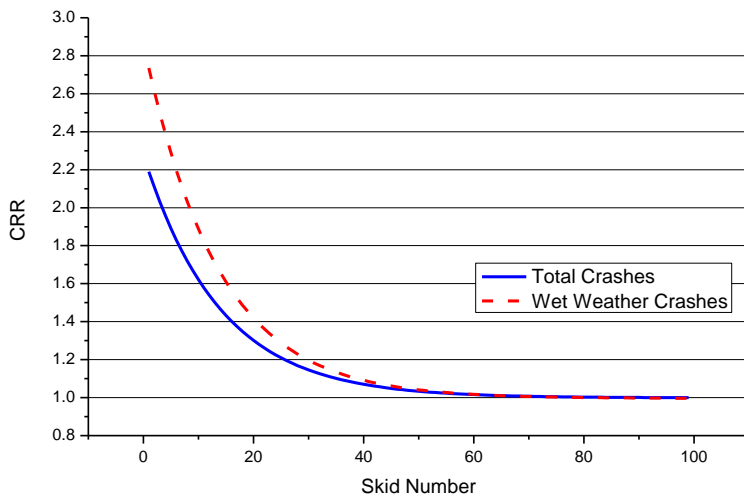
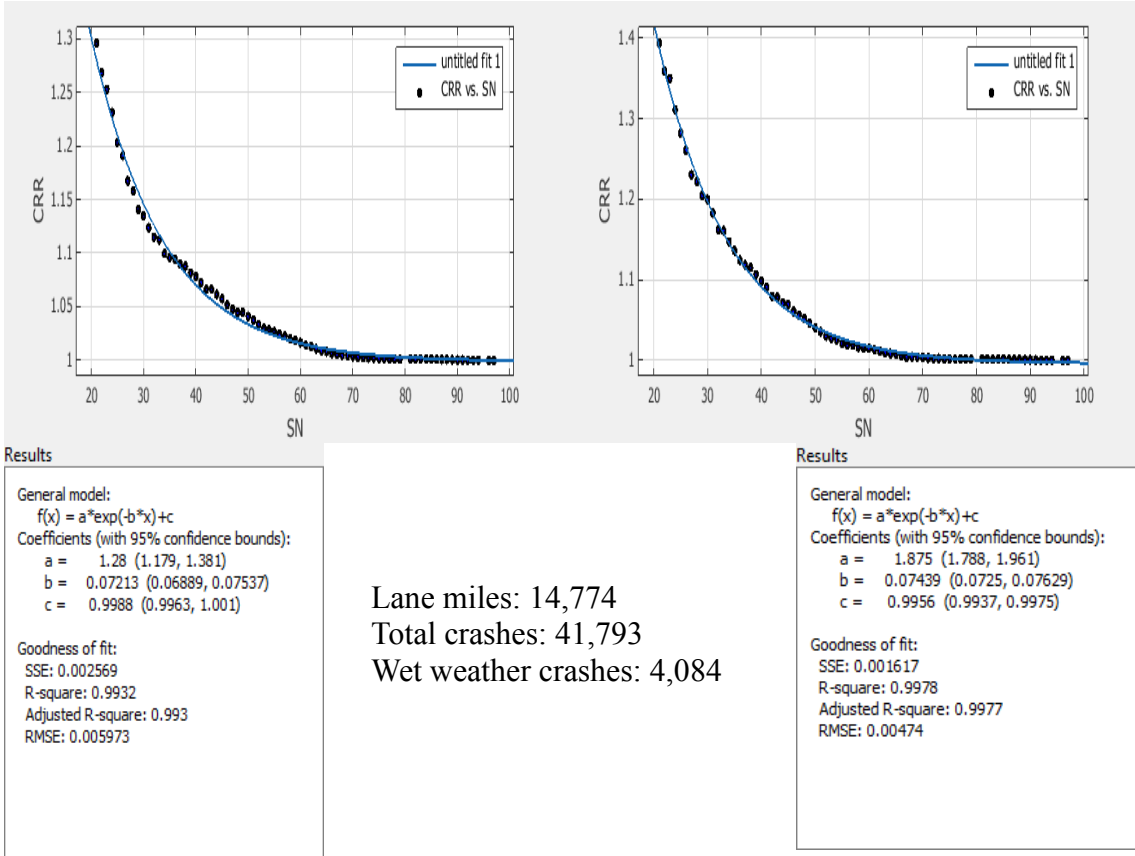

CRR-SN for total crashes:  
 $CRR = 1.280 \times e^{-0.0721 \times SN50S} + 0.9988$

CRR-SN for wet crashes:  
 $CRR = 1.875 \times e^{-0.0744 \times SN50S} + 0.9956$   
 When  $SN50S < 65$   
 $CRR = 1.280 \times e^{-0.0721 \times SN50S} + 0.9988$   
 When  $SN50S \geq 65$



A6. Group 6: High AADT per lane, Low Speed Limit, without Curve

Total Crashes

Wet Weather Crashes

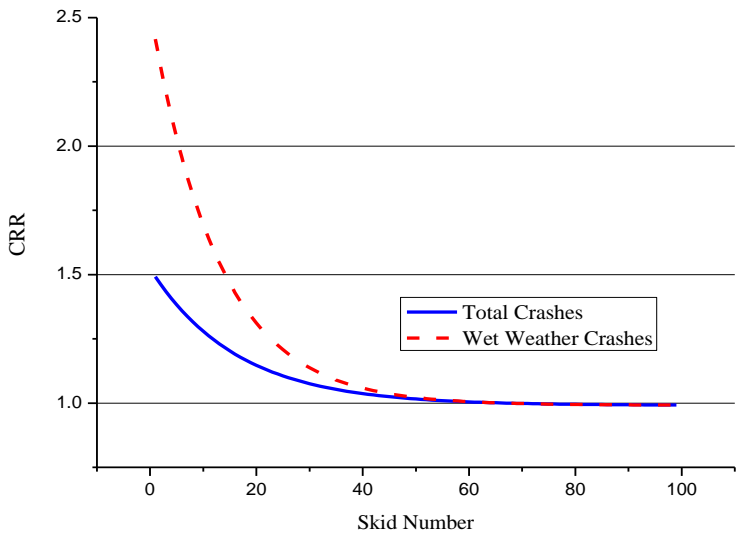
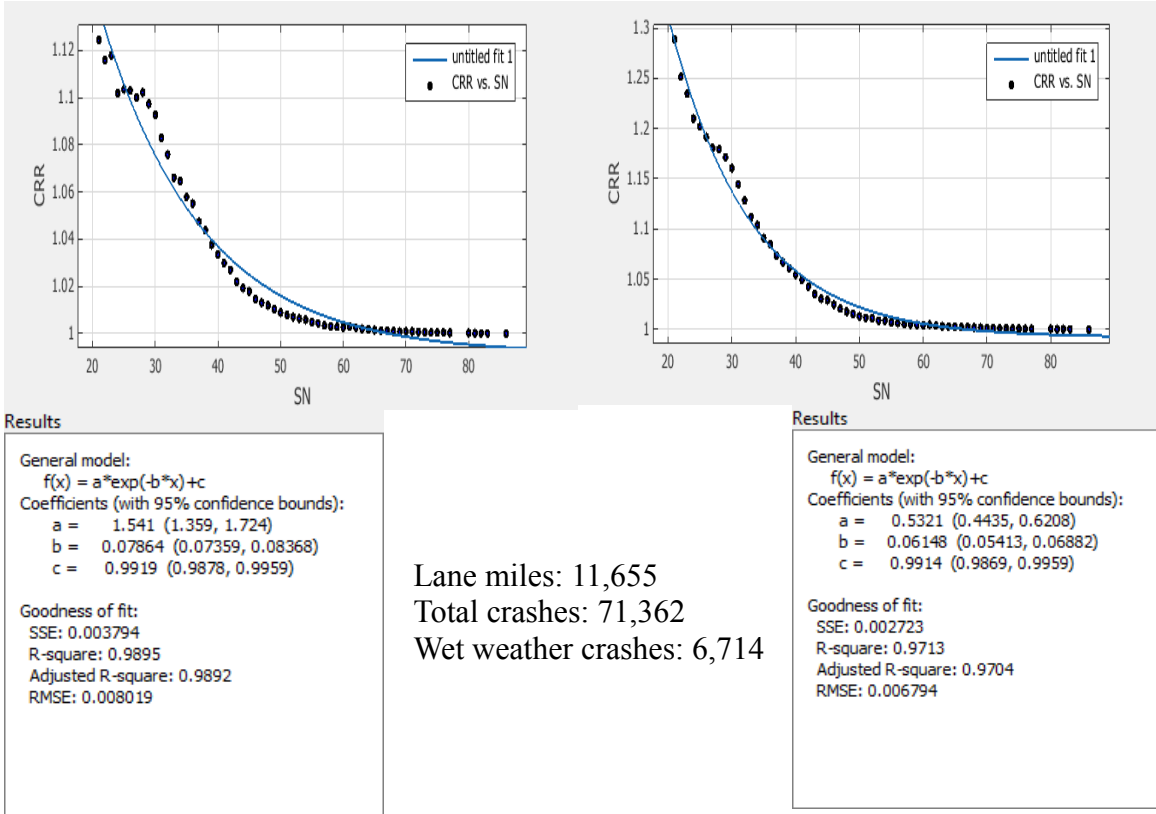

CRR-SN for total crashes:  
 $CRR = 1.541 \times e^{-0.0786 \times SN50S} + 0.9919$

CRR-SN for wet crashes:  
 $CRR = 0.532 \times e^{-0.0615 \times SN50S} + 0.9914$   
 When  $SN50S < 66$   
 $CRR = 1.541 \times e^{-0.0786 \times SN50S} + 0.9919$   
 When  $SN50S \geq 66$

A7. Group 7: Low AADT per lane, High Speed Limit, with Curve

Total Crashes

Wet Weather Crashes

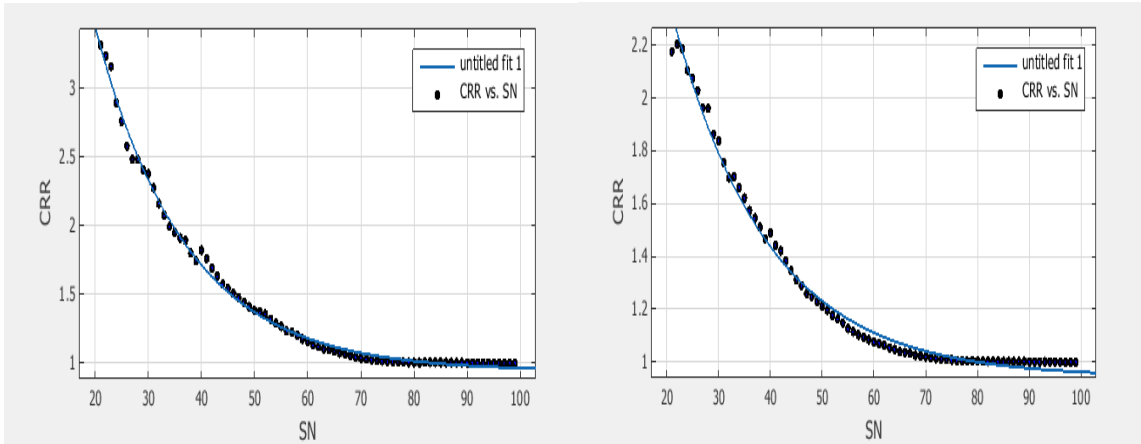

**Results**

General model:  
 $f(x) = a \cdot \exp(-b \cdot x) + c$   
 Coefficients (with 95% confidence bounds):  
 a = 4.27 (3.989, 4.552)  
 b = 0.0539 (0.05115, 0.05664)  
 c = 0.9429 (0.9263, 0.9595)

Goodness of fit:  
 SSE: 0.07703  
 R-square: 0.9924  
 Adjusted R-square: 0.9922  
 RMSE: 0.03184

Lane miles: 7,518  
 Total crashes: 2,051  
 Wet weather crashes: 226

**Results**

General model:  
 $f(x) = a \cdot \exp(-b \cdot x) + c$   
 Coefficients (with 95% confidence bounds):  
 a = 8.123 (7.705, 8.541)  
 b = 0.05875 (0.05664, 0.06087)  
 c = 0.9405 (0.9217, 0.9594)

Goodness of fit:  
 SSE: 0.1204  
 R-square: 0.9959  
 Adjusted R-square: 0.9958  
 RMSE: 0.0398

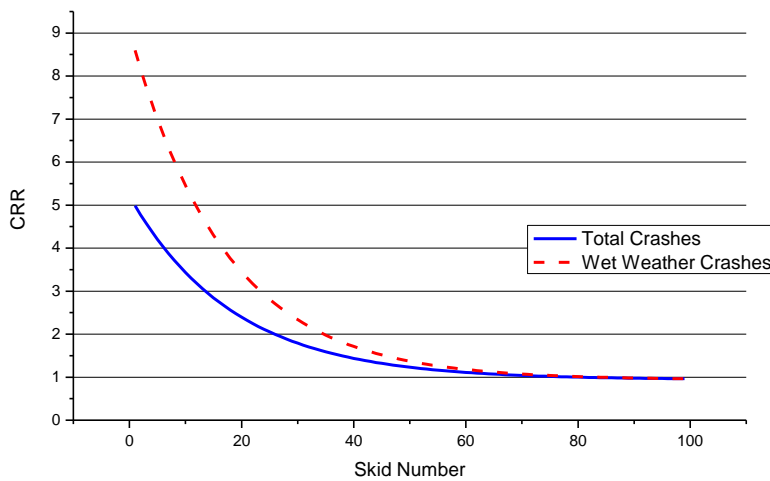

CRR-SN for total crashes:  
 $CRR = 4.270 \times e^{-0.0539 \times SN^{0.05}} + 0.9429$

CRR-SN for wet crashes:  
 $CRR = 8.123 \times e^{-0.0588 \times SN^{0.05}} + 0.9405$

A8. Group 8: Medium AADT per lane, High Speed Limit, with Curve

Total Crashes

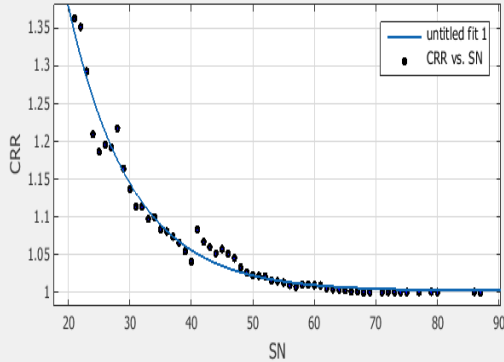

Wet Weather Crashes

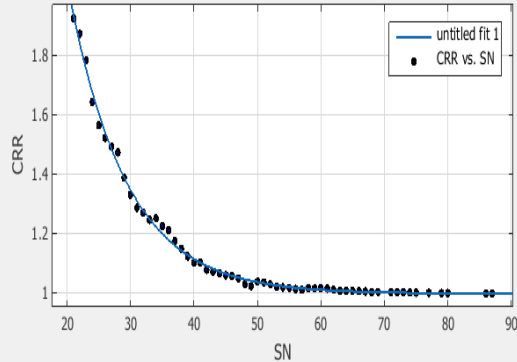

**Results**

General model:  
 $f(x) = a \cdot \exp(-b \cdot x) + c$   
 Coefficients (with 95% confidence bounds):  
 a = 2.64 (2.01, 3.269)  
 b = 0.09725 (0.08711, 0.1074)  
 c = 1.002 (0.9951, 1.009)

Goodness of fit:  
 SSE: 0.01289  
 R-square: 0.9712  
 Adjusted R-square: 0.9701  
 RMSE: 0.01517

Lane miles: 1,396  
 Total crashes: 1,959  
 Wet weather crashes: 400

**Results**

General model:  
 $f(x) = a \cdot \exp(-b \cdot x) + c$   
 Coefficients (with 95% confidence bounds):  
 a = 9.465 (8.585, 10.35)  
 b = 0.1099 (0.1059, 0.1138)  
 c = 0.9985 (0.9925, 1.004)

Goodness of fit:  
 SSE: 0.01174  
 R-square: 0.9962  
 Adjusted R-square: 0.9961  
 RMSE: 0.01448

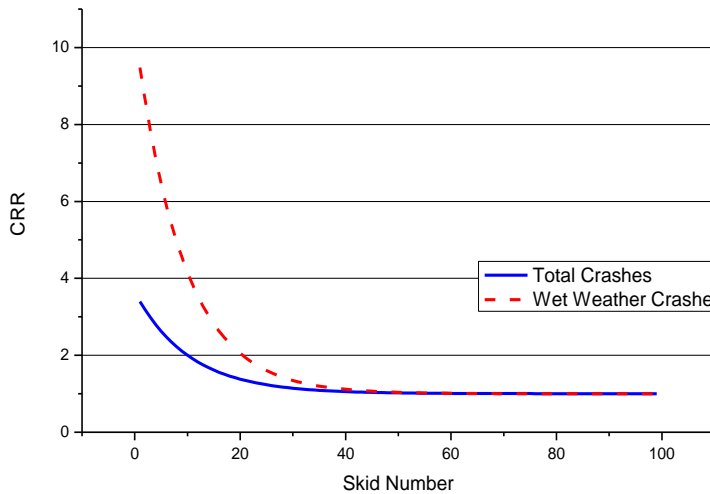

CRR-SN for total crashes:  
 $CRR = 2.640 \times e^{-0.0973 \times SN50S} + 1.002$

CRR-SN for wet crashes:  
 $CRR = 9.465 \times e^{-0.1099 \times SN50S} + 0.9985$   
 When  $SN50S < 64$   
 $CRR = 2.640 \times e^{-0.0973 \times SN50S} + 1.002$   
 When  $SN50S \geq 64$

A9. Group 9: High AADT per lane, High Speed Limit, Curve

Total Crashes

Wet Weather Related Crashes

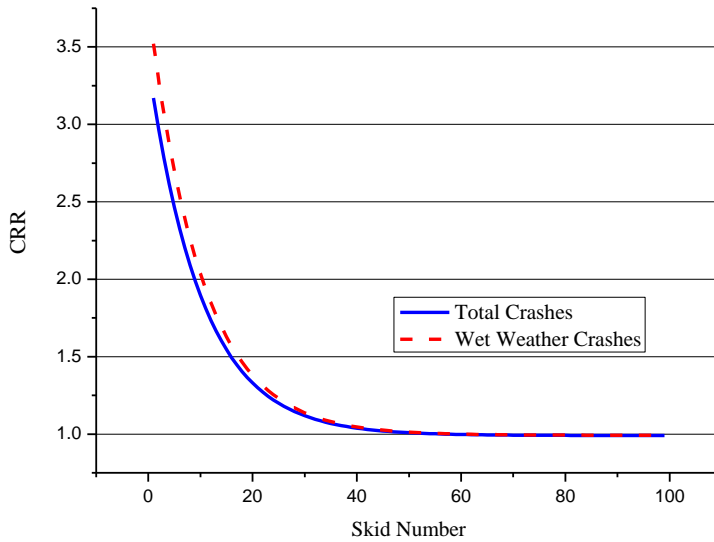
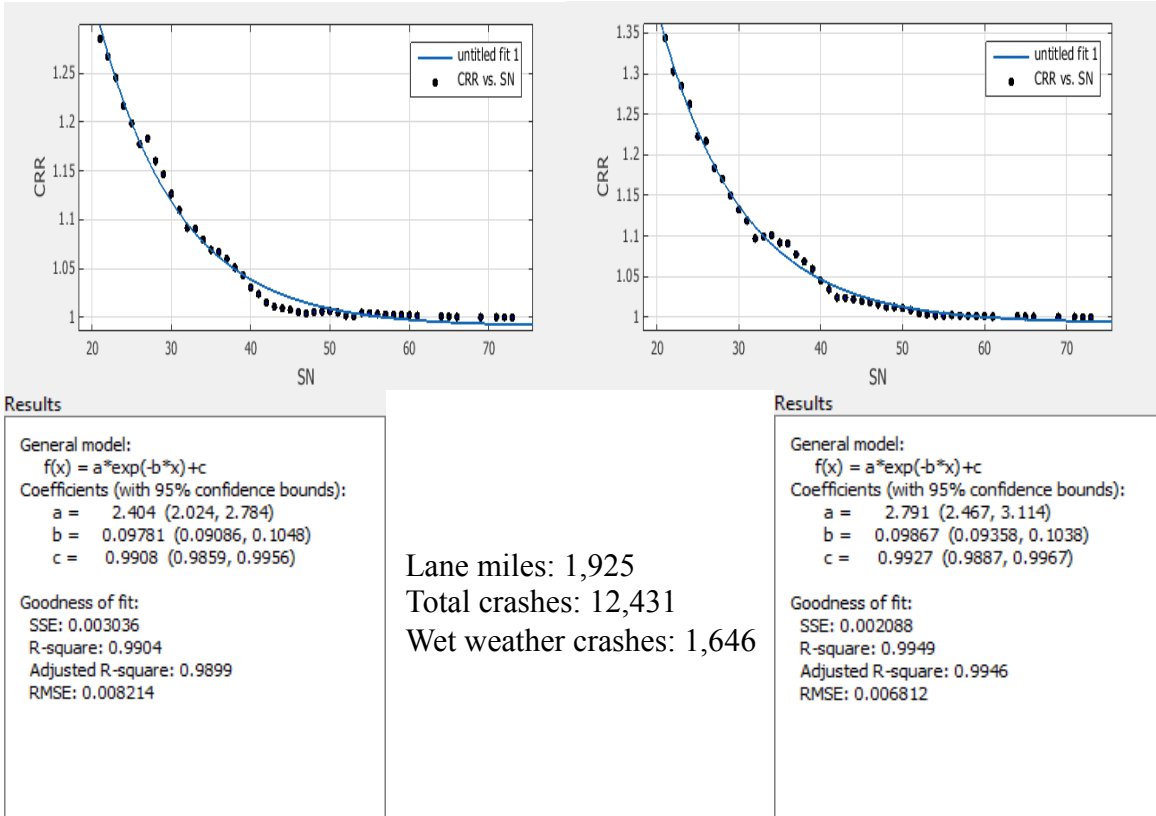

CRR-SN for total crashes:  
 $CRR = 2.404 \times e^{-0.0978 \times SN^{505}} + 0.9908$

CRR-SN for wet crashes:  
 $CRR = 2.791 \times e^{-0.0987 \times SN^{505}} + 0.9927$

A10. Group 10: Low AADT per lane, High Speed Limit, without Curve

Total Crashes

Wet Weather Crashes

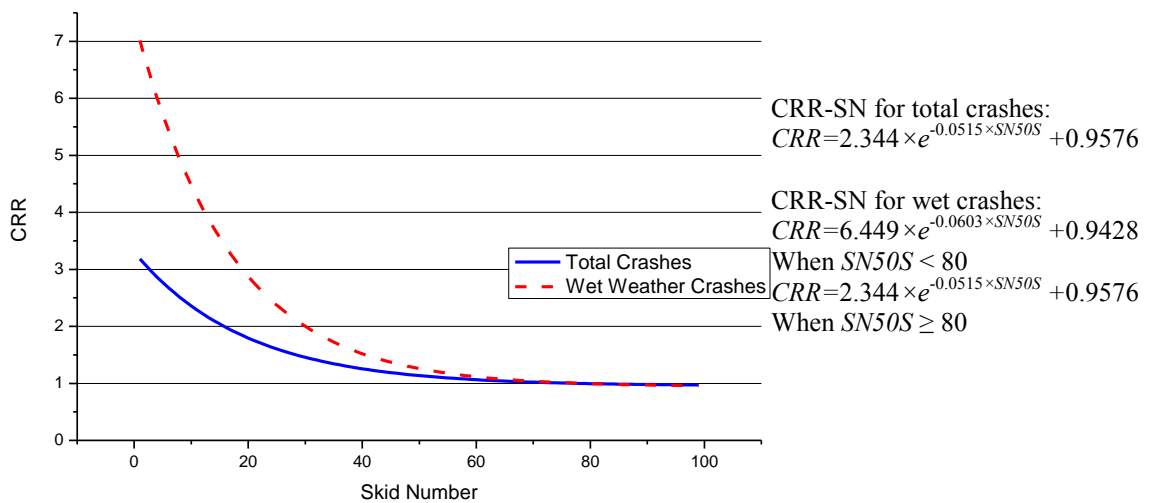
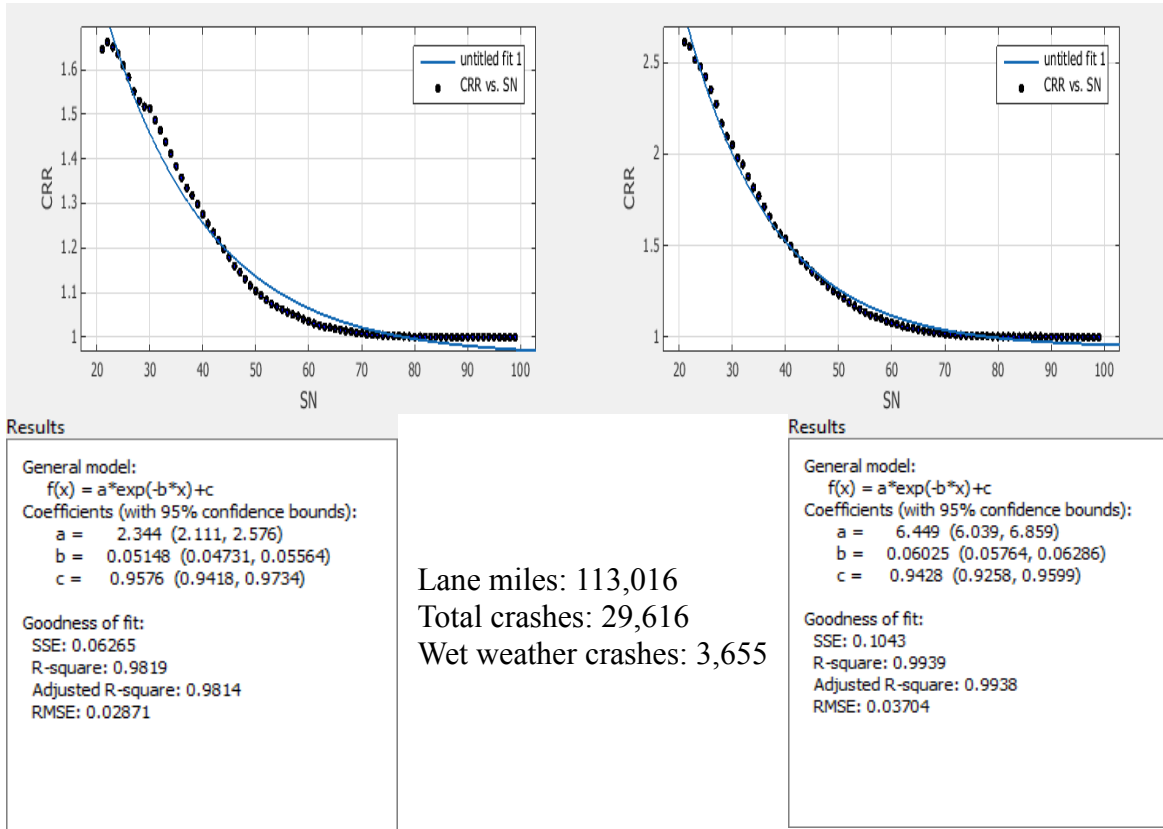

A11. Group11: Medium AADT per lane, High Speed Limit, without Curve

Total Crashes

Wet Weather Crashes

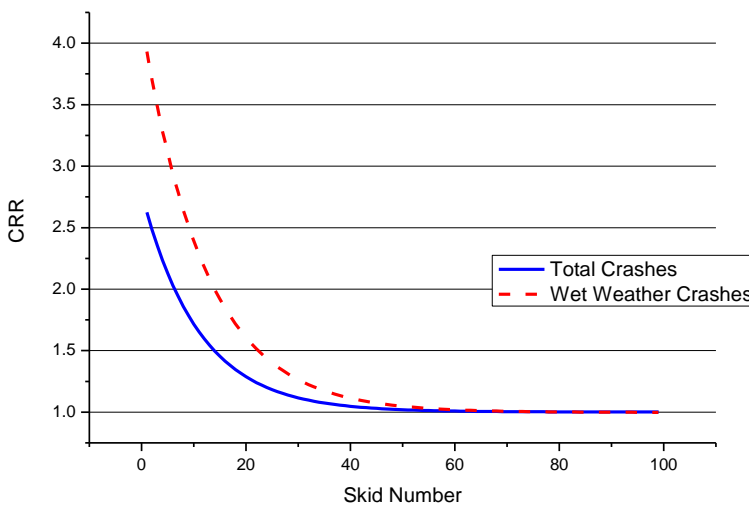
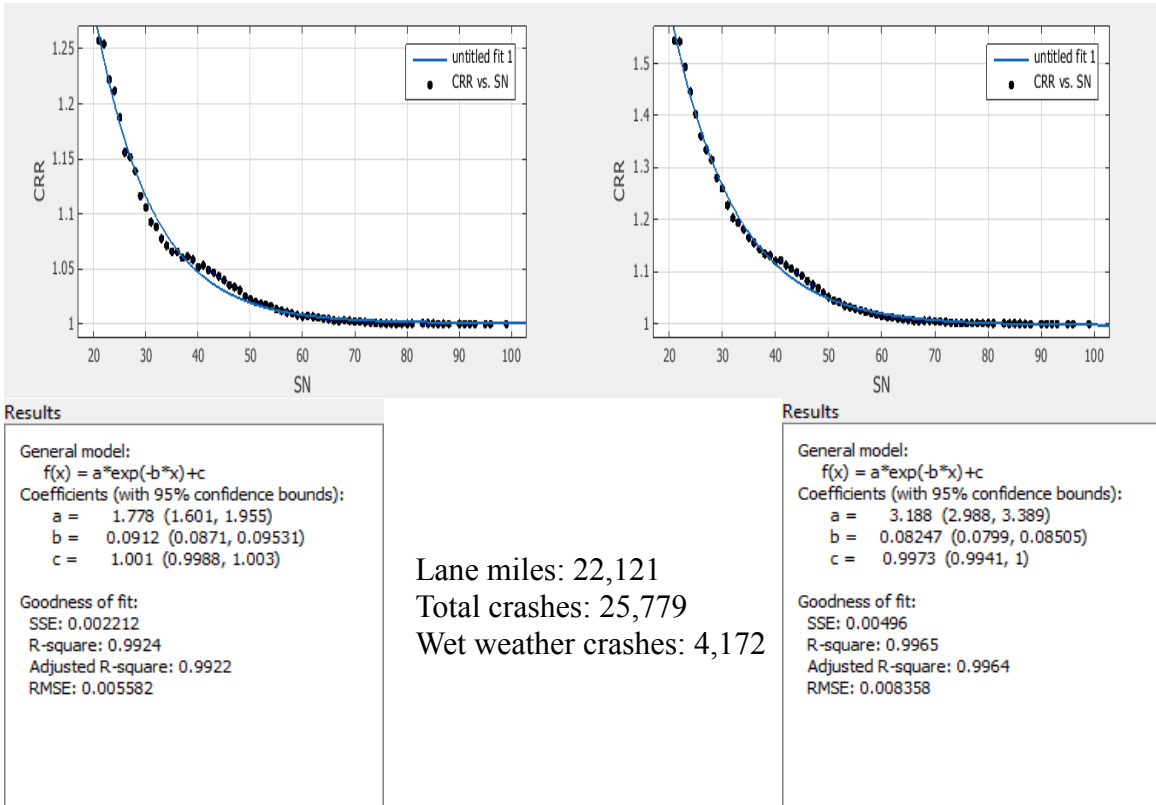

CRR-SN for total crashes:  
 $CRR = 1.778 \times e^{-0.0912 \times SN50S} + 1.001$

CRR-SN for wet crashes:  
 $CRR = 3.188 \times e^{-0.0825 \times SN50S} + 0.9973$

When  $SN50S < 80$   
 $CRR = 1.778 \times e^{-0.0912 \times SN50S} + 1.001$   
 When  $SN50S \geq 80$

A12. Group 12: High AADT per lane, High Speed Limit, without Curve

Total Crashes

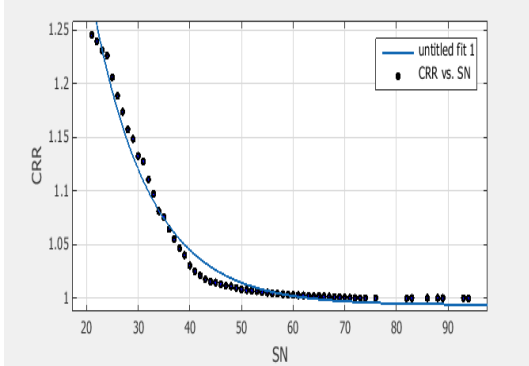

Results

General model:  
 $f(x) = a \cdot \exp(-b \cdot x) + c$   
 Coefficients (with 95% confidence bounds):  
 a = 1.909 (1.594, 2.224)  
 b = 0.09041 (0.08344, 0.09738)  
 c = 0.9938 (0.9895, 0.998)  
 Goodness of fit:  
 SSE: 0.005472  
 R-square: 0.9832  
 Adjusted R-square: 0.9826  
 RMSE: 0.00963

Wet Weather Crashes

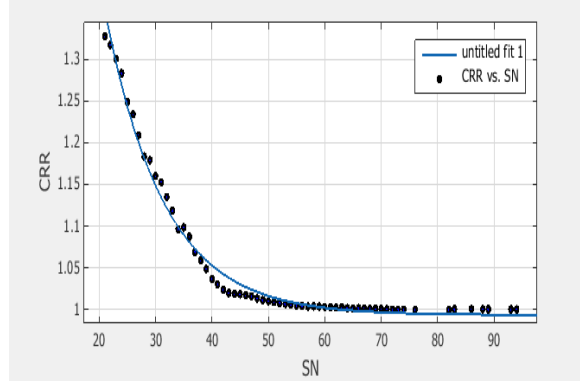

Results

General model:  
 $f(x) = a \cdot \exp(-b \cdot x) + c$   
 Coefficients (with 95% confidence bounds):  
 a = 2.735 (2.364, 3.106)  
 b = 0.09561 (0.08989, 0.1013)  
 c = 0.9931 (0.9891, 0.9972)  
 Goodness of fit:  
 SSE: 0.005461  
 R-square: 0.9895  
 Adjusted R-square: 0.9892  
 RMSE: 0.009621

Lane miles: 19,410  
 Total crashes: 87,505  
 Wet weather crashes: 11,669

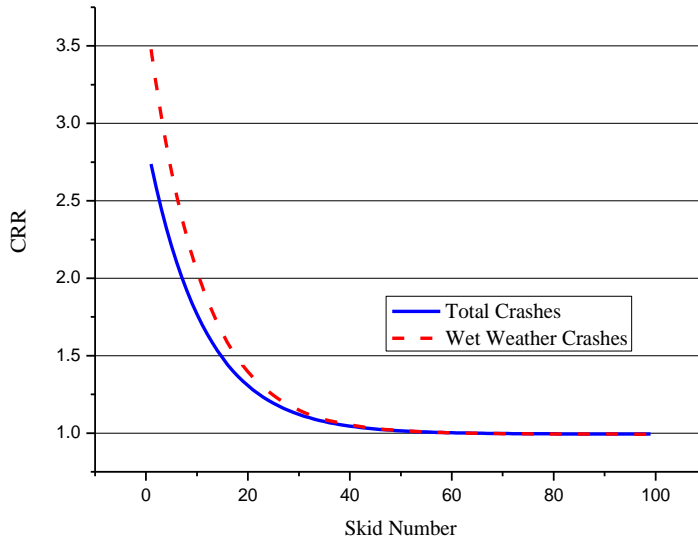

CRR-SN for total crashes:  
 $CRR = 1.909 \times e^{-0.0904 \times SN} + 0.9938$

CRR-SN for wet crashes:  
 $CRR = 2.735 \times e^{-0.0956 \times SN} + 0.9931$

When  $SN < 80$   
 $CRR = 1.909 \times e^{-0.0904 \times SN} + 0.9938$   
 When  $SN \geq 80$

## REFERENCES

1. Giles, C. G. (1957, February). THE SKIDDING RESISTANCE OF ROADS AND THE REQUIREMENTS OF MODERN TRAFFIC. ROAD PAPER NO 52. In *ICE Proceedings* (Vol. 6, No. 2, pp. 216-242). Thomas Telford.
2. Salt, G. F., & Szatkowski, W. S. (1973). *A guide to levels of skidding resistance for roads* (No. TRRL LR 510 R&D Rept.).
3. Roe, P. G., & Caudwell, L. (2008, May). Skid Resistance Policy in the UK—Where Did It Come From and Where Is It Going? In *Proceedings, International Safer Roads Conference*.
4. Sinhal, R. (2005). The implementation of a skid policy to provide the required friction demand on the main road network in the United Kingdom. *International Conference of Surface Friction*.
5. Henry, J. J., & Meyer, W. E. (1983). The Simulation of Tire Traction on Wet Pavements. In *Proceedings of the 18th International Automobile Technical Congress, Report* (Vol. 369, pp. 121-128).
6. Neaylon, K. (2011). *Guidance for the development of policy to manage skid resistance* (No. AP-R374/11).
7. Weligamage, J. (2006). Skid Resistance Management Plan. *Road Asset Management Branch, Queensland Department of Main Roads*.
8. Owen, M, Cook, D, & Cenek, P (2008) New Zealand state highway: skid resistance successes, International safer roads conference, 2nd, 2008, Cheltenham, United Kingdom, WDM, Bristol, UK.
9. McGovern, C., P. Rusch, and D.A. Noyce. (2011). *State Practices to Reduce Wet Weather Skidding Crashes*, Publication FHWA-SA-11-21, 2 FHWA, U.S. Department of Transportation, 2011.
10. Henry, J.J. (2000), *Evaluation of Pavement Friction Characteristics*, NCHRP Synthesis of Highway Practice 291, Transportation Research Board, National Research Council, Washington, D.C.
11. New York State Department of Transportation. (2002) Skid Accident Reduction Program, Engineering Instruction EI 02-007.
12. Mahone, D.C. and W.C. Sherwood. (May 1996). Virginias Wet Accident Reduction Program: A Users Manual. *Virginia Transportation Research Council*, Charlottesville, Virginia.
13. Larson, R. M. (1999). Consideration of Tire/Pavement Friction/Texture Effects on Pavement Structural Design and Materials Mix Design. *Office of Pavement Technology, HIPT*.
14. Vadakpat, G. C. (1994). *Analytical Study of Surface Friction of Wisconsin Trunk Highway System Pavements* (Doctoral dissertation, Masters Thesis, University of Wisconsin-Madison, Madison, WI).



15. Noyce, D.A., Bahia, H.U., Yambo, J.M., Guisk, K. (2005), *Incorporating Road Safety Into Pavement Management: Maximizing Asphalt Pavement Surface Friction for Road Safety Improvements*, Draft Literature Review & State Surveys, Midwest Regional University Transportation Center Traffic Operations and Safety (TOPS) Laboratory.
16. Hall, J.W., Smith, K., Titus-Glover, L., Yager, T. Rado, Z. (2009), *Guide for Pavement Friction*, NCHRP Web-Only Document 108:, Transportation Research Board, National Research Council, Washington, D.C.
17. TxDOT. *Wet Weather Accident Reduction Program*. Report. Texas Department of Transportation, 2006
18. Milton, J., V. Shankar, F. Mannering. Highway Accident Severities and the Mixed Logit Model: an Exploratory Empirical Analysis. *Accident Analysis and Prevention*, Vol. 40, No. 1, 2008, pp. 260–266.
19. Lehman Center for Transportation Research at Florida International University (LCTR). *Crash Reduction Analysis System Hub (CRASH)*. [lctr.eng.fiu.edu/CRASH.htm](http://lctr.eng.fiu.edu/CRASH.htm). Accessed July 5, 2013
20. Pardillo M. J. M., and R. J. Pina. An Assessment of the Skid Resistance Effect on Traffic Safety under Wet-Pavement Conditions. *Accident Analysis and Prevention*, Vol. 41, No. 4, 2009, pp. 881–886.
21. Caliendo, C., Guida, M., Parisi, A. (2007). A crash-prediction model for multilane roads. *Accident Analysis and Prevention* 39 (2007), 657–670.
22. Rizenbergs, R., Burchheit, J. C., & Warren, L. A. (1977). Relation of accidents and pavement friction on rural, two-lane-roads *Transportation Research Record* 633, 21-27.
23. Kuttesch, J.S. (2004), *Quantifying the Relationship between Skid Resistance and Wet Weather Accidents for Virginia Data*, Virginia Polytechnic Institute and State University, Blacksburg, Virginia.
24. Lindenmann, H. P. (2004). *Is the correlation between pavement skid resistance and accident frequency significant?* Presented at the TRB 83rd Annual Meeting, Washington, DC.
25. Rogers, M., Gargett, T. (1991). *A skidding resistance standard for the national road network*. *Highways and Transportation* 38 (4), 10–16.
26. Crash Records. *Crash Data Analysis and Statistics*. Texas Department of Transportation, Texas. [www.dot.state.tx.us/drivers\\_vehicles/crash\\_records/data.htm](http://www.dot.state.tx.us/drivers_vehicles/crash_records/data.htm). Accessed Jul. 10 2012
27. Zhang, Z., M. R. Rechtien, et al. *A Summary of Pavement and Material-related Databases within the Texas Department of Transportation*. Publication FHWA/TX-00/1785-1. TxDOT, 1999.
28. Tsyganov, A.R., R.B. Machemehl and M. Nicholas. *Safety Impact of Edge Lines on Rural Two Lane Highways*. Publication FHWA/TX-05/0-5090-1. FHWA, U.S. Department of Transportation, 2005.
29. National Safety Council (2010) *Estimating the Costs of Unintentional Injuries*.

30. Morian, D. (2011) Cost Benefit Analysis of Including Microsurfacing in Pavement Treatment Strategies & Cycle Maintenance. FHWA Report # FHWA-PA-2011-001-080503.
31. Oregon State University (2012) Pavement Management, Oregon State University Online Course
32. Solaimanian, M. and Kennedy, T. (1998) Evaluation of the Cape Seal Process as a Pavement Rehabilitation Alternative. Project Summary Report 1788-S.
33. 4-Year Pavement Management Plan (FY2012-FY2015). Texas Department of Transportation
34. Wallman, C. G., & Åström, H. (2001). *Friction measurement methods and the correlation between road friction and traffic safety*. Swedish National Road and Transport Research Institute.
35. Miller, M. M., & Johnson, H. D. (1973). *Effect of resistance to skidding on accidents: surface dressing an elevated section of M4 motorway* (No. R&D Rpt).
36. Kamel, N., & Gartshore, T. (1982). Ontario's Wet Pavement Accident Reduction Program. *Pavement Surface Characteristics and Materials, ASTM STP, 763*, 98-117.
37. Schlosser, M. H. (1976). Traffic accidents and road surface skidding resistance. *Transportation Research Record*, (623).
38. McCullough, B. F. (1966). Skid resistance guidelines for surface improvements on Texas highways. *Highway Research Record*.
39. Guidelines for the Management of Road Surface Skid Resistance. Austroads Publication No. AP-G83/05. Sidney, 2005.
40. Holbrook, L. F. (1976). *ACCIDENT RATES AND SURFACE PROPERTIES--AN INVESTIGATION OF RELATIONSHIPS* (No. FHWA-MI-76-994 Final Rpt.).
41. Seiler-Scherer, L. (2004). Is the correlation between pavement skid resistance and accident frequency significant. In *Conference Paper STRC*.
42. Cenek, P. D., Davies, R. B., Loader, M., & McLarin, M. W. (2004, November). Crash risk relationships for improved safety management of roads. In *Proceedings Towards Sustainable Land Transport Conference*.
43. Piyatrapoomi, N., Weligamage, J., Kumar, A., & Bunker, J. (2008). Identifying Relationship Between Skid Resistance and Road Crashes using Probability-Based Approach. In *Proceedings* (Vol. 13).